



This is a digital copy of a book that was preserved for generations on library shelves before it was carefully scanned by Google as part of a project to make the world's books discoverable online.

It has survived long enough for the copyright to expire and the book to enter the public domain. A public domain book is one that was never subject to copyright or whose legal copyright term has expired. Whether a book is in the public domain may vary country to country. Public domain books are our gateways to the past, representing a wealth of history, culture and knowledge that's often difficult to discover.

Marks, notations and other marginalia present in the original volume will appear in this file - a reminder of this book's long journey from the publisher to a library and finally to you.

Usage guidelines

Google is proud to partner with libraries to digitize public domain materials and make them widely accessible. Public domain books belong to the public and we are merely their custodians. Nevertheless, this work is expensive, so in order to keep providing this resource, we have taken steps to prevent abuse by commercial parties, including placing technical restrictions on automated querying.

We also ask that you:

- + *Make non-commercial use of the files* We designed Google Book Search for use by individuals, and we request that you use these files for personal, non-commercial purposes.
- + *Refrain from automated querying* Do not send automated queries of any sort to Google's system: If you are conducting research on machine translation, optical character recognition or other areas where access to a large amount of text is helpful, please contact us. We encourage the use of public domain materials for these purposes and may be able to help.
- + *Maintain attribution* The Google "watermark" you see on each file is essential for informing people about this project and helping them find additional materials through Google Book Search. Please do not remove it.
- + *Keep it legal* Whatever your use, remember that you are responsible for ensuring that what you are doing is legal. Do not assume that just because we believe a book is in the public domain for users in the United States, that the work is also in the public domain for users in other countries. Whether a book is still in copyright varies from country to country, and we can't offer guidance on whether any specific use of any specific book is allowed. Please do not assume that a book's appearance in Google Book Search means it can be used in any manner anywhere in the world. Copyright infringement liability can be quite severe.

About Google Book Search

Google's mission is to organize the world's information and to make it universally accessible and useful. Google Book Search helps readers discover the world's books while helping authors and publishers reach new audiences. You can search through the full text of this book on the web at <http://books.google.com/>



3 3433 06274485 3



ANNALS OF PHILOSOPHY;
OR, MAGAZINE OF
CHEMISTRY, MINERALOGY, MECHANICS,
NATURAL HISTORY,
AGRICULTURE, AND THE ARTS.

BY THOMAS THOMSON, M.D. F.R.S. L. & E. F.L.S. &c.
MEMBER OF THE GEOLOGICAL SOCIETY, OF THE WERNERIAN SOCIETY, AND OF THE
IMPERIAL MEDICO-CHIRURGICAL ACADEMY OF PETERSBURGH.

VOL. X.

JULY TO DECEMBER, 1817.



London:

Printed by C. Baldwin, New Bridge-street;

FOR BALDWIN, CRADOCK, AND JOY,
47, PATERNOSTER-ROW.

1817.

TABLE OF CONTENTS.

NUMBER LV.—JULY, 1817.

	Page
Biographical Account of Dr. Jean de Carro	1
Suggestions and Remarks on Naval Subjects, on Rigging, on Steering, on the Form of the Rudder, on Anchors: with Observations on the Height of Masts and upper Sails, on the Dry Rot, and on the Felling and Preservation of Timber. By Col. Beaufoy.....	6
Register of the Weather for Six Months at Malone House and Dublin. By Anthony Semple, Esq.	11
On the Cells and Combs of Bees. By Dr. Barclay.....	14
Account of different Currents of Wind observed at the same Time. By T. L. Dick, Esq.	16
On Vision. By J. Campbell, Esq.....	17
Method of preserving Volatile and Deliquescent Substances. By Dr. Dewar.....	29
Report made by M. Poisson of a Memoir by M. Hachette respecting the Running of Liquids through small Orifices, and with Pipes applied to these Orifices.....	31
Determination of the primitive Form of Bitartrate of Potash. By Dr. Wollaston	37
Appendix to the Essay on the Chemical Compounds of Azote and Oxygen. By Mr. J. Dalton	98
Description of an Absence Thermometer. By A. Semple, Esq.....	47
Critical and Analytical Account of the Transactions of the Royal Society of Edinburgh, Vol. VIII. Part I. 1817	49
Proceedings of the Royal Society, May 22, June 5, 12, and 19	54
————— Linnæan Society, May 24, June 3, and 17.....	56
————— Royal Society of Edinburgh, May 19.....	57
————— Geological Society, April 6, and May 2.....	58
————— Royal Geological Society of Cornwall.....	59
Notice of a Lecture.....	61
Further Improvements in Professor Leslie's Method of producing Ice	ibid.
Philosophical Society of London.....	62
Prize Question by the Royal Medical Society of Edinburgh	63
Query respecting the Diseases of the West Indies	ibid.
On sailing to the North Pole	ibid.
Description of a Machine for raising heavy Weights, called a Jack. By Mr. Moyle	65
Query respecting the Mode of freeing Wine from common Salt	66
Proposed Improvement in Brooke's Blow-pipe. By Mr. Barchard	ibid.
Another Improvement. By Mr. Booth	67
Arithmetical Query.....	68
Singular Formation found within an Egg. By Mr. Strutt.....	69
Effect of different Rocks in Scotland on the Magnetic Needle. By Mr. Webster	ibid.

	Page
Fusion of Wood Tin	70
Turkey Oil-stone	71
Black Powder remaining after the Solution of Tin in Muriatic Acid	ibid.
Holmite	ibid.
Account of a very remarkable Mineral Water. By Mr. Garden	72
New Patents	73
Scientific Books in the Press.....	75
Col. Beaufoy's Magnetical and Meteorological Observations for May	76
Mr. Howard's Meteorological Journal, May 8 to June 5	79

—◆—

NUMBER LVI.—AUGUST.

Biographical Account of M. Rochon	81
Appendix to the Essay on the Chemical Compounds of Azote and Oxygen. By Mr. J. Dalton, <i>concluded</i>	83
A general Formula for the Analysis of Mineral Waters. By Dr. Murray	93
On the Salts composed of Sulphuric Acid and Peroxide of Iron. By Dr. Thomson	98
Mode of exploring the Interior of Africa. By H. Edmonston, Esq.....	103
On the Spur of the Ornithorhynchus Paradoxus. By M. H. de Blainville..	112
Table showing the Quantity of Soda contained in Barilla, &c. By C. Tennant, Esq.	114
Table of Differential Equations. By Mr. J. Adams.....	116
Experiments on the Composition and Properties of the Naphtha of Amiano. By M. Theodore de Saussure	118
Critical and Analytical Account of Cuvier, <i>La Règne Animal</i>	127
————— Mr. Donovan's Essay on Galvanism..	129
Experiments with the Gas Blow-pipe. By Dr. Clarke	133
Proceedings of the Royal Society, June 26	139
————— Geological Society, May 16, June 6, and 20	ibid.
————— Royal Academy of Sciences.....	141
A Descending Spout on Land. By L. Howard, Esq.....	146
Gum from the Congo.....	147
Disappearance of Saturn's Ring	148
Deuto-sulphuret of Copper	ibid.
Hydrates of Tin	149
Butter of Antimony.....	ibid.
Emetin.....	150
Insects living in a Vacuum	151
New Method of detecting Arsenious Acid, or Corrosive Sublimate, when in Solution.....	ibid.
Arragonite	ibid.
New Analysis of the Meteoric Iron of Siberia.....	152
Serpent found in Devonshire.....	ibid.
Translator of Euler's Algebra	ibid.
Death of Mr. Gregor.....	153
Morphium	ibid.
<i>New Patents</i>	154

	Page
Scientific Books in the Press.....	155
Col. Beaufoy's Astronomical, Magnetical, and Meteorological Observations, for June.....	156
Mr. Howard's Meteorological Journal, June 6 to July 5.....	159

NUMBER LVII.—SEPTEMBER.

Biographical Account of Dr. Ingenhousz. By the late Dr. Garthshore..	161
Chemical Analysis of Cornish Tin. By Dr. Thomson	166
A general Formula for the Analysis of Mineral Waters. By Dr. Murray, concluded	169
On the Vessels of Plants. By Dr. Wahlenberg	177
Analysis of Rice. By M. Henri Braconnot	186
Memoir on the Sodalite of Vesuvius. By M. Le Comte Borkowski	192
Chemical Examination of a Quantity of Sugar supposed to have been intentionally poisoned. By Dr. Gorham.....	197
Experimental Researches on the Ammoniacal Salts. By Dr. Ure	203
Report on Hachette's second Memoir on the running of Fluids through various Orifices.....	214
Proceedings of the Royal Academy of Sciences	221
Notices of Lectures.....	227
Ores of Cobalt	228
Register of the Weather at New Malton, in Yorkshire	230
Explosion in a Durham Coal-pit.....	231
———— on Board a Coal Vessel	233
Coal in Russia	ibid.
Query respecting the Matter concreted at the Bottom of Coppers	ibid.
Experiment of Lampadius	ibid.
Note respecting the Sugar of the Acer Pseudoplatanus. By Mr. Cadell..	234
Mineralogy and Geology	ibid.
Correction of a Mistake in the Epitome of Mr. Solly's Paper given in the Account of the Meetings of the Geological Society. By S. Solly, Esq.	235
Col. Beaufoy's Astronomical, Magnetical, and Meteorological Observations, for July	236
Mr. Howard's Meteorological Journal, July 6 to Aug. 4	239

NUMBER LVIII.—OCTOBER.

Description of the Laurus Cinnamomum. By H. Marshall, Esq.	241
Suggestions for building experimental Vessels for the Improvement of the Navy, with Remarks on the present Mode of Construction: and some Experiments on the comparative Resistance of Water on differently shaped Solids. By Col. Beaufoy	246
Elementary Ideas on the First Principles of Integration, by Finite Differences. By Mr. G. Harvey	264
On the Quantity of real Acid in liquid Hydrochloric, and on the Composition of some of the Chlorides; with the Description of a new Instrument for the Analysis of the Carbonates. By Dr. Ure	268

	Page
Mode of exploring the Interior of Africa. By H. Edmonston, Esq. <i>concluded</i>	278
Extraordinary Case of a Blind Young Woman who can read by the Points of her Fingers. By the Rev. T. Glover.....	286
Proceedings of the Royal Academy of Sciences.....	290
Curious Effect of Paste on Iron.....	302
Further Improvements in the Oxygen and Hydrogen Blow-pipe.....	303
On a Lactometer. By Mr. Johnson.....	304
On a Rain-gauge. By the Same.....	305
On preparing Extracts, &c. By the Same.....	306
Observations on the Nomenclature of Clouds.....	ibid.
On the Hedgehog.....	307
Prizes of the Royal Academy of Sciences and Belles Lettres of Brussels for the Year 1818.....	308
Translator of Euler's Algebra—Heat generated by the Rupture of Iron Bars.....	311
External Application of Sulphurous Acid as a Remedy.....	312
Expanding Rigger.....	313
Mill-stones.....	ibid.
Inverted Rainbow.....	314
Chemical Equivalents.....	ibid.
On impregnating Water with Carbonic Acid by the Syringe of Mr. Brooke's Blow-pipe.....	ibid.
Notices of Lectures.....	315
Col. Beaufoy's Magnetical and Meteorological Observations, for August..	316
Mr. Howard's Meteorological Journal, Aug. 5 to Sept. 2.....	319

—◆—

NUMBER LIX.—NOVEMBER.

Biographical Account of Dr. Brownrigg. By Dr. Dixon.....	321
Explanation of the Characteristics d and δ . By Mr. Adams.....	338
Solution of the Equation $\psi^x = x$. By Mr. Horner.....	341
Of Cinnamon as an Article of Commerce. By H. Marshall, Esq.....	346
Description of Mr. Wynn's Timekeeper and Pendulum.....	365
Improvement in the Oxygen and Hydrogen Blow-pipe. By Mr. Osbrey..	366
A General Table of the Proportions of dry Muriatic Acid corresponding to progressive Specific Gravities of the liquid Acid; with Observations on the Law of Progression. By Dr. Ure.....	369
Improvement in the Gas Blow-pipe; with some additional Remarks upon the Revival of Metals from their Oxides, and of the Fusion of refractory Bodies, by Means of the same Instrument. By Dr. Clarke.....	373
Proceedings of the Royal Academy of Sciences.....	377
Arragonite.....	387
Barley.....	388
Malt.....	ibid.
Brewing.....	389
Effect of Lightning on a Tree.....	ibid.

	Page
Register of the Weather at New Malton, in Yorkshire	390
Kidney Bean and Common Bean Perennials	391
Royal Geological Society of Cornwall.....	392
Remarkable Action of Paste on Cast-Iron	394
New Scientific Books in the Press	395
Col. Beaufoy's Magnetical and Meteorological Observations, for Sept. ..	396
Mr. Howard's Meteorological Journal, Sept. 3 to Oct. 2	399

NUMBER LX.—DECEMBER.

Biographical Account of Dr. Brownrigg. By Dr. Dixon, <i>concluded</i>	401
Application of Fluxions to Lines of the Second Order or Degree. By Alex. Christison, Esq.	417
On the North-West Passage; and the Insular Form of Greenland. By Col. Beaufoy.....	424
On the Cells of Bees. By Mr. Barchard.....	428
Demonstration of a Mathematical Theorem. By Mr. J. Adams.....	430
On some Points relating to Vision	432
Register of the Weather in Plymouth for the last six Months of 1816. By J. Fox, jun. Esq.	434
Biographical Sketch of Ventenat	440
Account of the Ballston Waters.....	442
Critical and Analytical Account of Dr. Marcet's Essay on the Chemical History and Medical Treatment of Calculous Disorders	443
Analytical Account of the Philosophical Transactions of the Royal Society of London for the Year 1817, Part I.....	446
Proceedings of the Royal Academy of Sciences.....	452
Titanium and Tellurium in Sulphuric Acid.....	464
Service of Plate presented to Sir H. Davy.....	ibid.
Case of Miss M'Avoy	465
Mineral Water of Schooley's Mountain.....	ibid.
Patent Malt	ibid.
Atmospherical Phenomeon	467
Aerolite at Paris	ibid.
List of Patents	468
Col. Beaufoy's Magnetical and Meteorological Observations, for Oct.	470
Mr. Howard's Meteorological Journal, Oct. 3 to Nov. 1	473
Index	475

PLATES IN VOL. X.

Plate	Page
LXVIII. Table of the Barometer and Thermometer at Belfast and in Dublin, Sept. 1816, to March, 1817.....	11
LXIX. Currents of Wind.....	16
LXX. An Absence Barometer, &c.....	48
LXXI. The Cinnamon Tree	256
LXXII. On the Construction of Ships, &c.	258
LXXIII. Dr. Clarke's Gas Blow-pipe, &c.....	373
LXXIV. On Vision, &c.	433
LXXV. The Barometer and Thermometer at Plymouth	434

ERRATUM IN VOL. X.

No. LIX. page 258, line 9, *for* stopped, *read* stepped.

ANNALS

OF

PHILOSOPHY.

JULY, 1817.

ARTICLE I.

Biographical Account of Jean de Carro, M.D.

JEAN DE CARRO, a physician practising at Vienna, was born at Geneva, Aug. 8, 1770. He is descended from one of the most ancient families of that little independent state. Already in the beginning of the 15th century, members of this family had there filled the highest posts of trust; had served as distinguished officers in the armies of different powers, particularly in Russia; and had united themselves by marriage with the other ancient and noble families of Geneva.

In the year 1790, de Carro, having completed his general studies, went to Edinburgh, a University for which his countrymen had always a great predilection, in order to pursue his medical studies. On June 24, 1793, he obtained the degree of Doctor, after having publicly defended An Inaugural Dissertation de Hydrocephalo Acuto, which was also printed.

On returning to his native country, he found it in a state of agitation which must have rendered it a most unfit residence for a young man of inquiring mind, desirous of information. He determined, therefore, to pursue his studies at the University of Vienna, at which he entered in the year 1794. His intention was during a year to profit by all the opportunities which the hospital, and the other institutions of this capital, would afford; and then, prepared with fresh stores of knowledge, to return to his native town.

The French revolution, the influence of which extended even to Geneva, the change which took place in the government, and the barbarous way in which this change was brought about, induced De Carro to remain in Vienna, to await another order of things, and in the mean time to enrol himself in the medical body of that city.

Successful practice, and, above all, his marriage with the Traulein von Kurzbeck, in 1795, induced him to take up his residence permanently in Vienna, where, after the customary examinations, he was formally admitted, in 1796, as a Member of the Faculty of Medicine.

De Carro's scientific connexion with England had scarcely made him acquainted with Jenner's important discovery of the cow-pox, and put him in possession of his work, which appeared in 1798, when he, relying implicitly on the accuracy and skill of Jenner, endeavoured to obtain matter, and resolved to make the first trial upon his own sons, Carl and Peter. These children, then, on May 10, 1799, became the first subjects of the cow-pox inoculation upon the continent of Europe, and of course in the Austrian monarchy.

Two months afterwards he subjected them both, under the observation of physicians who had obtained the public confidence, to the inoculation of the small-pox, which, as was to be expected, was found deprived of all its injurious influence upon the protected children.

Moravia was the first province of the Austrian monarchy in which the Graf Hugo Salm, under the direction of De Carro, and by his disinterested assistance, introduced in a short time the general use of the cow-pox inoculation.

De Carro was required by the Archduke Charles to draw out a statement and instructions how the vaccine might be best introduced into all the establishments for the children of the military, and particularly those of the frontier regiments. When he had completed this, in a manner suited to the objects in view, the Commander, in a private audience, thanked him, in the name of the state and of the army, in the most flattering terms. On March 10, 1803, the Imperial Council of War issued an order that the German edition of De Carro's first work upon the vaccine (*Observations et Experiences sur la Vaccine*) should be distributed to all the medical officers of the army, that it might serve them as an instruction and rule. In this order the work is styled "the best which has made its appearance upon the subject."

After he had propagated the vaccine inoculation, not only through the whole of the Austrian monarchy, but introduced it into many other countries of Europe, and to this end maintained an epistolary correspondence with other countries, in which the Government took upon themselves to promote the beneficial discovery, and communicated his letters to committees named for the purpose; after he had instructed young men gratis, rendered the modes of conveying the matter more simple, and improved them by the adoption of ivory needles; De Carro determined to introduce the vaccine matter over land into the rich country of India, where the small-pox was feared as the wicked deity presiding over the cradle of infant man—no one having yet succeeded, what care soever had been adopted, in introducing it uninjured, and possessed of its power, when carried by sea.

The skilful manner in which he contrived to convey the matter in its fluid state from Vienna to Constantinople, to Bagdad, Bassora, Bushire upon the Persian Gulf, Bombay, Goa, Ceylon, Sumatra, and the chief islands of Asia, is fully described in the work which he wrote, entitled, "*Histoire de la Vaccination en Turquie, en Grece, et aux Indes Orientales.*" The pains which he thus unsolicitedly took; and induced merely by an ardent wish for the good of mankind, to extend the blessing of the vaccine to the British possessions in the East, obtained for him flattering expressions of thanks from the British Government in that country. In the year 1814 the East India Company voted the sum of 200*l.* for the purchase of a piece of plate, as a mark of their acknowledgment. The same year the Hon. Jonathan Duncan, Governor of Bombay, sent to De Carro's lady a valuable present of articles of Eastern manufacture. The Hospodar of Moldavia, Alexander Moroust, and that of Wallachia Constantine Pysilandi, into whose states he had introduced the vaccine, likewise sent him valuable presents.

Of all the compliments which foreign countries paid to De Carro, nothing gratified him so much as the present of a simple silver snuff-box which he received from Jenner as his "most deserving follower," on which the name of this benefactor of mankind was associated with that of De Carro in this simple inscription—"Edward Jenner to Jean de Carro."

Jenner gave this mark of his respect and his esteem only to two of his disciples—to the Austrian physician De Carro, as the first propagator of the vaccine on the European continent and in Asia; and to Dr. Benjamin Waterhouse, an American physician of the University of New Cambridge, in North America, who in that quarter of the world did what De Carro had done for the greater part of Europe.

In the third part of Jenner's work he speaks of De Carro as the first who out of England had trodden in his footsteps.

While De Carro, besides cultivating the knowledge of his profession, kept pace with the other branches of literature, and particularly busied himself in the study of travels, in order that he might learn the peculiar advantages enjoyed by other countries, and devise the means by which they might be transferred to his own, the name of the dry or mountain rice became known to him, the peculiar nature of which is shown by its growing in the cool, dry, and high regions of Asia, instead of the marshy grounds in which rice is usually cultivated. The idea of bringing this plant into Europe, of making it usurp the place of the ordinary rice, and thus putting a stop to all those diseases which afflict the countries where the latter kind is cultivated, inspired his mind, and, with his accustomed eagerness, he applied himself to the object. He wrote to the numerous supporters and friends whom he had obtained in those countries by his correspondence respecting the vaccine, and requested not only rice seed, but all those seeds which he could with any good ground suppose might be beneficial in Europe. All his

attempts were vain to obtain these seeds by the way of Bombay, Bagdad, or Bassora ; but he addressed himself with a more fortunate result to Dr. Rehmann, who accompanied, as physician, the great Russian expedition to China. In Kiachta, a small town of Siberia on the borders of the Chinese empire, Rehmann received his friend's request, and fulfilled his wishes with exactness and speed. A more particular account of this plant, and of its culture, is to be found in the *Bibliothèque Britannique* published at Geneva, to which De Carro has furnished many valuable articles. Great, and scarcely to be anticipated, are the benefits which must arise from the introduction of this Asiatic plant into Europe, as was the case with many of the plants introduced into Europe by the crusades. The older botanists have named this plant *Oryza Mutica* ; more modern writers, in thankful remembrance of the person who introduced it into Europe, the *Oryza De Carro*.

This rice appears only to have answered in the warmer parts of Hungary and of Lombardy. Graf Herbustein, the Vice President of the Council, caused seeds to be procured from De Carro, and several experiments to be made in the Bannat.

De Carro, whose mind was ever actively employed in some useful pursuit, was struck with the spirit of patriotism which breathed from every line of a German biographical work recently published under the title of the *Austrian Plutarch* ; and in order to extend the sphere of its utility, spent some of the tranquil hours which his profession afforded him in translating it into French. This excellent translation, which may boast of the life and energy of an original, was dedicated to the present Archduchess of Parma, at that time the Empress Maria Louisa, who complimented the translator with a handsome snuff-box, as a testimony of the satisfaction with which she had perused the work. The excellent observations of Frederick Schlegel upon this laborious, and in every respect most successful translation by De Carro, in the first volume of the *Æstereichischen Beobacter* for 1810, are very worthy of perusal.

Amongst the various services which De Carro has rendered to the Austrian people, it may be worthy of mention that he was the means at different times of procuring large importations of merino sheep from Lancy, which were particularly fit for improving the breed of sheep, and by this means the national wealth. His connexion with Carl Pictet de Rochement, a State Counsellor of Geneva, and well known both as a learned man and an improver of the breed of sheep, enabled De Carro to do this.

During the Congress of Vienna, Lord Castlereagh requested De Carro, to whom the English language is as familiar as the French, to translate an English work against the slave-trade, in which all the horrors of this trade, so disgraceful to humanity, are disclosed. De Carro produced, in a very short time, a translation of this work, to the full satisfaction of the author, as will appear from the following letter :—

“ MY DEAR SIR,

Vienna, Nov. 14, 1814.

“ The Viscount Castlereagh has directed me to convey to you his thanks for the translation which you have made of the abstract of the evidence concerning the slave-trade, and to express to you his entire satisfaction at the able manner in which you have executed it.

“ The conviction which this transaction has already created in the minds of the different powers of Europe here assembled in Congress, not only of the cruelty and inhumanity, but of the impolicy of this traffic, will, it cannot be doubted, tend very considerably to reconcile these powers, who until now have persisted in this barbarous trade, to a more speedy abandonment of it than could have been otherwise expected; and your name, which is already associated with one of the greatest benefits that mankind has received (from the propagation of the vaccination), will be recorded amongst those of the persons who have exerted themselves in bringing about the abolition of practices so barbarous and infamous, that posterity will with difficulty be induced to believe that they could have been sanctioned by any civilized nations of Europe in the nineteenth century.

“ I have the honour to assure you of the esteem with which

“ I am, my dear Sir, your very obedient servant,

“ FRANCIS PETER WERRY,

Attached to the mission of Viscount Castlereagh during Congress.”

The readers of the *Bibliothèque Britannique* have often observed with pleasure and instruction the zeal with which De Carro embraces every thing which can enrich science, increase prosperity, or diminish suffering; and how frequently he has that great, though unfortunately often unacknowledged merit, to be the organ by which unknown truths have been uttered and made known, and thus become useful and effective. It is only necessary to consult for this purpose his letters to the Editor on the subjects of vaccination, the plague, the plica polonica, the science of medicine amongst the Hindoos, on the Guinea worm, on hydrophobia, on meteoric stones, on the thermolampe, on mountain rice, and other foreign plants, and, lastly, his translation of some remarkable historical details respecting the castle of Durenstein, and the confinement of Richard Cœur de Lion by Baron Hormays.

ARTICLE II.

Suggestions and Remarks on Naval Subjects, on Rigging, on Steering, on the Form of the Rudder, on Anchors; with Observations on the Height of Masts and upper Sails, on the Dry Rot, and on the Felling and Preservation of Timber. By Col. Beaufoy, F.R.S.

THE usual mode of supporting the masts of large ships by cordage is attended with the disadvantage of an enormous pressure on the bottom of the vessel, and in some instances in line of battle ships, that part of the keel immediately under the lower extremity of the mast has been bent downwards several inches, a circumstance not only injurious to the strength, but also detrimental to the sailing of the ship. It is evident the use of ropes will always be productive of this inconvenience, because a sufficient power must be applied in setting up the rigging to stretch the cordage prior to the vessel's going to sea, otherwise the shrouds would become slack, and endanger the safety of the masts. An 80 gun ship has nine shrouds on each side of the main-mast cable laid, and which, if of Captain Huddart's manufactory (whose superiority admits of no competition), and $10\frac{3}{4}$ inches in circumference, will bear about 32 tons weight. The power usually employed in setting up each of the shrouds cannot be less than half this weight; consequently the stress is equal to the total weight all the shrouds on one side would sustain. By measuring the distance of each shroud from the mast, and also the length of the shroud when set up, the angle each shroud makes with the horizon will be as follows:—

Shrouds.	Angles.	Tons.
1	68° 46'	29·825
2	68 40	29·807
3	68 16	29·725
4	66 58	29·449
5	65 46	29·180
6	65 09	29·037
7	62 57	28·500
8	62 01	28·259
9	60 10	27·760

Total 261·545

The first column contains the number of shrouds, 1 being the foremost, and 9 the aftermost. In the second column the angles each shroud makes with the deck are set down: and the third column contains the weight, 32 tons, reduced in the proportion of radius to the sine of the angles $68^{\circ} 46'$, $68^{\circ} 40'$, and so on. In

this calculation the pressure caused by the topmast and topgallant shrouds, backstays, &c. is not included, nor the weight of the masts, yards, sails, rigging, &c. Could any method be devised to reduce this enormous pressure, with equal security to the mast, it would be very advantageous to the vessel. In small ships, iron shrouds have been adopted with success. Constructed of solid links, and made as light as by experiment is found to be of sufficient strength, would still be an improvement, because iron chains constructed in the usual manner elongate when a heavy strain is applied to their extremities.* It is evident no more power would be requisite to set up the iron shrouds than is necessary to form a straight line from the mast head to the channels; and when once properly arranged, they would be unaffected by dryness or moisture, two inconveniences cordage must suffer from inevitably, in spite of tar or any other substance which can be introduced among the yarns. Iron, it is true, will be affected by heat and cold; but the elasticity of the lanyards would compensate for the expansion and contraction of the iron.

Instead of having all the shrouds go over the mast head, the two foremost should be secured to the mast somewhat below the wake of the lower yards. This alteration would be attended with two advantages: first, that in case the mast head was either shot or carried away, two pair of shrouds would be left to support the remainder of the mast: and, secondly, by having these two pair of foremost shrouds below the yards, the yard would brace up sharper. These shrouds also might be placed before the centre of the mast, which would be an additional security to the masts when the sails are braced aback. If the shrouds placed before the mast interfere with the lee leech of the sail when upon a wind, or are found inconvenient when hoisting things in and out of the ship, they may be set up by runners and tackles. It would be advantageous if the two aftermost pair of shrouds were set up prior to the mast being stayed forward, they would resist a purchase applied to the stay of 15† tons, and consequently prevent the mast being crippled by that quantity.

A tiller † is preferable to a yoke or cog wheels to steer with, because it brings less strain on the pintles and gudgeons of the rudder. The tiller may be compared to weighing a heavy body with a steelyard, and the yoke or cog wheels to weighing it in a pair of scales: it is evident there is more stress on the pivot of a pair of scales than on the pivot of a steelyard with the same weight.

The present form of rudders has an advantage which appears not

* A circular iron bar one inch in diameter, and six feet long, weighs 15·88 lb. Avoir., and will sustain, when in a vertical position, 24·13 tons hung to its extremity. A fathom of cordage weighs 26·3 lb. Avoir. If the weight of the rope be called 1000, the weight of the iron will be 6038; and if the residual strength of the shroud when set up be called 1000, the strength of the iron shroud will be 1508.

† The best angle for the rudder to make with the ship's keel is 30°, not as determined by theory 54° 44'. (See *Annals* for August, 1816.)

to have struck those who propose to get rid of that part which, they have thought, has no power to steer the vessel when making head way; for one-third of the rudder, counting from the bottom, is probably then the only part which has any effect to govern the vessel; and in full-built vessels, such as Dutch, not more than one-fourth, or even less. When the vessel makes a stern board, the length of rudder immersed in the water should equal the vessel's draft of water, and as much rudder should be above the water as is equal to the heaping up of the water by the ship's stern way. It has often excited my surprise that round headed rudders are not introduced in the navy, as they are found to answer in East India ships of 1600 tons, and which at times have been laden with 2000 tons. There appears no reason why men of war should not find them equally serviceable; for can any thing be more unmechanical than to have a large hole in the counter for the rudder head, which is afterwards closed up with a piece of tared canvass to prevent the water getting in? It is probable that vessels with low counters by getting stern way in bad weather by losing this piece of canvass have foundered.

When large ships lose their rudders at anchor, the accident is attributed to the vessel's striking; but, more possibly, it is caused by the centrifugal force (if the expression may be used) of the ship's suddenly rising after pitching heavily, combined with the resistance of the water to the flat under side of the rudder. If the under side of the rudder were a semicircle, it would offer one-third less resistance to the water; for the resistance of a semicircle as found by experiment is to the resistance of its diameter nearly as 30 to 91. The rudder would be more endangered, hung in the present manner, if it were constructed of lighter materials, or made hollow like a box to increase its buoyancy.*

The mode of making large anchors is imperfect, from the impossibility of welding the internal bars without burning the outer ones. Cast-iron anchors would be of advantage to the service, as they are lighter, and probably stronger, if their brittleness were not an objection; but might it not be obviated by covering the crown of the anchor with rope, or some other elastic or soft substance? The strong prejudice which first existed against iron cables is so much diminished, that they are daily introduced into use. The objections to cast-iron anchors might be equally unfounded; and if every ship

* The late Earl Stanhope (whom every lover of science must lament) contrived an equipoise rudder, which was fixed to a schooner rigged vessel, built according to his Lordship's plan, and under his direction. This rudder, instead of being hung in the usual manner to the sternpost, turned on pivots, fixed (in the first instance) to the centre of the rudder, under the idea that the water acting on each side of the rudder would balance it, and thereby take away all strain on the tiller; but on trial it was found necessary, to produce the equilibrium, that the pivots should be placed one-third of the rudder's length from the sternpost. This proves that an accumulation takes place on that part of the opposing surface first impinged; a circumstance, I believe, unnoticed by any writer on the resistance of fluids.

in the navy, and in the East India Company's service; was furnished with an additional anchor of cast-iron, the advantages or the contrary would be fairly ascertained.

Some professional men are of opinion that lofty masts have a greater power than short masts to impel ships with a progressive velocity, independently of their setting more sail. But the subsequent experiment proves the fallacy of this idea. To the head and stern of the model of a cutter, and at equal heights above the surface of the water, two strings were attached, each of which passed over very accurate pulleys fixed on the outside of the tub in which the model floated. To the end of each line was hung 8 oz.; and to the weight at the head was added as much more as enabled it to draw the model and raise the stern weight. The line was afterwards taken from the head, and fastened to the mast head; and the pulley being also raised, the result was the same, except that the *stem* was immersed three-tenths of an inch more in the latter than in the former case.*

Vessels designed like cutters to carry large aftersails and small head ones must be built to draw much more water abaft than forward; for it is the lateral resistance of the water abaft against the thin and extended surface of the vessel which counterbalances, without much use of the helm, the power of the mainsail to turn the vessel's head to wind. Therefore Euler, and other theoretical writers on ship-building, are mistaken in supposing the difference of the draft of water of the head and stern counteracts the impulse of the sails to depress the head or bow.

In some of the ships of the navy built of British oak, the dry rot has commenced in the treenails made of American wood; a circumstance that deserves attention, to ascertain by experiment if all foreign woods used for treenails produce the same mischievous consequences, which should especially be guarded against, considering the price and scarcity of English oak. With the view of determining this point, it is proposed to perforate a large and sound piece of English oak with several holes, and drive into them 11 treenails of each different kind of wood fit for ship-building, and number them one, two, three, &c. Annually let one treenail of each sort of wood be driven out and examined, and a memorandum made of the state and appearance, &c. of every one, beginning with No. 1, and so on in succession. This plan should be inverted, and logs of foreign timber undergo the same trial. The reason for naming the number eleven is because that is the average period a ship in the navy lasts; but when that is said, it must not be supposed at the end of that time the ship is decayed or worth nothing, but only during eleven years as much money has been expended on the ship in repairs as would have rebuilt it.

The short duration of a vessel in the navy naturally leads to the

* Probably an additional quantity of canvass, by having squarer yards in the topgallant and royal sails, would answer better than having loftier sails.

inquiry to what extraordinary circumstance is the durability of the Royal William of 80 guns to be attributed. It was launched in 1719, had no repairs till 1757, and was broken up in 1813, a period of 94 years; and even then many of the original timbers were found undecayed, and which were made into snuff-boxes and other trinkets, highly prized by the curious as an uncommon instance of durability. It did not appear when the vessel was taken to pieces that any unusual mode was adopted to preserve the timber; and the enigma must be solved by referring to documents for the means taken in seasoning timber employed in ship-building at that time. About the latter end of the reign of James II. it appears three different modes were adopted in felling of timber:—1. In the spring of the year, when the sap was risen, and the trees began to bud, they were cut down and barked; consequently the sap was left in the trunk. 2. The tree was barked first, and then left standing until the winter, when it was felled. 3. The tree was cut down in the winter time. It appears an order was issued in 1687 or 1688 for 150 trees in Bushey Park to be stripped of their bark in the month of April, and left standing until December. The result, however, does not appear to be known. If, therefore, these experiments were repeated by any gentleman resident in the country who is felling trees for building or repairing, he would essentially serve his country; and by communicating the result in the different durability of the timbers to the public, merit the gratitude of our sailors and the naval world at large.

In our naval arsenals the usual manner of keeping timber is by piling the trees horizontally one over another, which prevents a free circulation of air, and the under trees are frequently injured by the exuding moisture and the dripping of the rain from the upper ones. Notwithstanding the labour, it would finally be more economical if the timber were placed in a vertical position with proper supports to rest against, and pieces of plank nailed on the top of each tree, which would prevent it splitting, by securing it from the action of the sun and frost; and if the bottom were protected by standing the trees on a sloping pavement of flag stones.

Formerly ship planks had the requisite degree of curvature given them by the action of fire, which to a certain degree charred the wood. The modern system of bending the planks by steam is certainly more expeditious; but the former method has been practised from time immemorial to preserve timber exposed to air and moisture, and on that account should be preferred. The durability of the ship would compensate for the trouble and expense, if the surface of the component parts of the frame, &c. were charred before they were put together.

These hints, and those in the third volume of the *Annals of Philosophy*, p. 470, the writer trusts may induce others to improve on them for practical advantages to our navy and merchantmen.

ARTICLE III.

Register of the Weather for Six Months, at Malone House and Dublin. With a Plate (LXVIII.) exhibiting the Variations of the Barometer and Thermometer at each place. By A. Semple, Esq.

(To Dr. Thomson.)

MY DEAR SIR,

Malone House, May 2, 1817.

My nephew, Mr. Moore, of Dublin, and I, have for some time kept a comparative register of the barometer, thermometer, and weather; the scale of which, from the autumnal equinox of 1816 to the vernal one of this year, I now send you, in hopes that it may be thought worthy of a place in the *Annals of Philosophy*.

This station is situated about three English miles WSW of Belfast, in the county of Antrim; 98 English miles (by the road) NE of the city of Dublin; and is about 143 feet above the level of the sea, the other station being about 30 feet above the same level.

The column of mercury in both barometers has been (through-out) reduced, to what it would have been at 32° Fahr.

Believe me, dear Sir, yours very sincerely,

ANTHONY SEMPLE.

September, 1816.

MALONE HOUSE.

DUBLIN.

23. Cirrus and Cirrostratus. Eve clear. N.	Very fine morning.
24. Cirrus. 9 P.M. a luminous arch, E to W. S.	Very fine day.
25. Fine day. Cumulus. SE.	Very fine day.
26. Rain and hail. Eve fine. NW.	Hazy morn. Rain, noon.
27. Hazy, with frequent showers. NW.	Fine morning.
28. Hazy and showery. SSE.	A fine day.
29. Constant rain in forenoon. WSW.	Violent rain in first part.
30. Showery, with hail. WSW.	Showery.

October.

1. Nimbus, with showers. WSW.	Hazy morn. Little rain. W.
2. Rainy morn. Fair eve. W.	Dark day. W.
3. Fair. Beautiful Cirrocumuli. ESE.	Cloudy morn. SE.
4. Incessant rain. WSW.	Dark damp day.
5. Fair. Showers at night. WSW.	Fine morn. Wet afternoon. S.
6. Fair. Showers at night. SE.	Cloudy, and very wet. E by S.
7. Hazy morn. Clear eve. E.	Wet morn and eve. Fair noon. E by S.
8. Rain, morn. Hazy eve. E.	Wet morn, after light showers. ESE.
9. Hazy, with frequent showers. E.	Wet morn, after light showers. ESE.
10. Hazy morn, with showers. W.	Damp cloudy morning. E.
11. Hazy morn. Fair eve. Nearly calm. W.	Fine day. Cloudy eve. W.
12. Hazy, with light air. SW.	Very fine day. W.
13. Fine morn. Evening, showers. SW.	Very fine day. W.
14. Fair. Beautiful Cirrocumulus. SW.	Very fine day. W.
15. Hazy, but no rain. WSW.	Very fine day. Very bright. S by W.
16. Fair morn. Eve, heavy rain. WSW.	Hazy morn. Wet eve. NW.
17. Hazy, with showers. WSW.	Bright morn, and fine day. SW

October.

MALONE HOUSE.

18. Fine day. Cumulus. NW.
19. Cirrocumulus. Blowing hard. WNW.
20. Cumulus. Blowing very hard. NW.
21. Cirrocumulus. Showers. NW.
22. Blowing fresh, with showers. WNW.
23. Squally, with showers. SSW.
24. Hazy, with frequent showers. SSE.
25. Hazy, with frequent showers. SSE.
26. Morn, heavy rain. Eve, showers. SE.
27. Hazy, with some showers. ESE.
28. Cumulus and Cirrocumulus. E.
29. Hazy and showery. E.
30. Hazy. Blowing hard. ENE.
31. Fair. Blowing fresh. ENE.

DUBLIN.

- Bright morn, and fine day. W.
 Fine day, not bright. SW.
 Fine day. Rain at night. SW.
 Bright morn, and fine day. SW.
 Fine day. Brisk wind. SW.
 Bright morn. Wet eve. SW.
 Bright morn. Wet night. SW.
 Showery. Night fair. SW.
 Very wet day. SE.
 Dark hazy day. E.
 Fine morn, after showers. E.
 Cloudy morn; rain after. E.
 Cloudy morn. Wet eve. E.
 Shower, morn. Eve cloudy. E.

November.

- | | |
|--|-------------------------------------|
| 1. Fine day. A slight shower. E. | Bright morn. Fine day. W. |
| 2. Cumulus, with slight showers. WSW. | Bright morn. Fine day. W. |
| 3. Hazy, with showers. ENE. | Wet morn. Fine afternoon. W. |
| 4. Cumulus and Cumulostratus. ENE. | Fine day. Rain at night. NE. |
| 5. Dark weather. No rain. ENE. | Very hazy day. E. |
| 6. Fine morn. Eve, heavy showers. Var. | Fine morn. Showery eve. NW. |
| 7. Morn, snow lies three inches. NNW. | Fine day. W. |
| 8. Bright morn. Snow showers. WSW. | Fair day. SW. |
| 9. Showery. Blowing very hard. N by W. | Showery and windy. NW. |
| 10. Showers of snow, lies 4 in. NNE. | Bright day. N. |
| 11. Blowing very hard, with rain. Var. | Showery day. Storm at night. Var. |
| 12. Blowing hard, with rain. NW. | Hazy day. SW. |
| 13. Blowing hard, with rain. NW. | Bright morn. Wet eve. W. |
| 14. Blowing very hard, with snow. WNW. | Dark, with sleet. W. |
| 15. Blowing very hard, with rain. NNW. | Dark, with rain. W. |
| 16. Blowing fresh. Cumulus. NW. | Fine. |
| 17. Morn, rain. Eve fair. WSW. | Continued rain. W by S. |
| 18. Morn, showers. Eve fair. WNW. | Bright morn, and fine day. W. |
| 19. Morn, showers. Eve fair. WSW. | Hazy morn. Fair day. SW. |
| 20. Fair. Clouds various. SW. | Fine day. Stormy night. S. |
| 21. Fair. Clouds various. SSW. | A fine day. S. |
| 22. Fair. Clouds various. SSE. | Bright morn, and fine day. SE. |
| 23. Fine day. Clouds various. ESE. | Fine day. SE. |
| 24. A dark day. ESE. | Fine day. S. |
| 25. Morn, showers. Eve fine. W. | Fine day. SW. |
| 26. Eve, showers, and blowing fresh. SW. | Day fine. Night stormy and wet. SW. |
| 27. Eve, crimson Cirri. Var. | Day fine. Night windy. SW. |
| 28. Dark weather. Little wind. NNW. | Very fine. SW. |
| 29. Fine day. Cumulus. NNW. | Fine day. Hazy at sea. W. |
| 30. Dark weather. W. | Fine day. W. |

December.

- | | |
|--|-------------------------------|
| 1. Dark weather, with haze. W. | Weather fair. W. |
| 2. Hazy, with some rain. NW by N. | Weather fair. W. |
| 3. Hazy, with a light breeze. NNW. | Weather fair. W. |
| 4. Hazy, with a light breeze. SW by S. | Cloudy. Storm at night. E. |
| 5. Blowing hard, and constant rain. SSE. | Very wet and stormy. E. |
| 6. Dark, with haze. W by N. | Some rain and blowing. W. |
| 7. Bright morn. Dark eve. W. | Blowing, bright morn. SW. |
| 8. Fine day. Cloudless. ENE. | Day fine and bright. W. |
| 9. Morn, constant rain. Var. | Day very wet. Night fair. W. |
| 10. Bright morn. Eve wet. SW. | Storm, with heavy showers. S. |

December.

MALONE HOUSE.

11. Lightning. Snow showers. WSW.
12. Fine day. Snow lies $1\frac{1}{2}$ in. WNW.
13. Rain and snow. Var.
14. Frequent showers of sleet. Var.
15. Fine day. Cloudless. WNW.
16. Dark, with snow showers. W.
17. Hazy, with some rain. SW.
18. Hazy. Aurora Borealis. Var.
19. Cloudless sky. NE.
20. A fine day. WNW.
21. Dark, with rain in evening. SW.
22. Bright morn. Rain in evening. NW.
23. Dark, with frequent showers. SW.
24. Dark, with frequent showers. SW.
25. A fine day. WSW.
26. Fine morn. Eve, snow. WSW.
27. Cumulus. Some snow. W.
28. Morn, constant rain. Eve fair. SW.
29. Fine day. Cumulus. WSW.
30. Dark, with sleet. Var.
31. Dark, with rain. SE.

DUBLIN.

- A little snow, morn. S by W.
 Fine morn. Wet eve. E by S.
 Little snow. Cloudy. W to S by W.
 Morn frosty. Heavy rain.
 Fair.
 Fair, with frost. Fine day. W.
 A few slight showers. SW.
- Fine day. W by N.
 Thick fog. Dark day. W by N.
 Fine day. W by N.
 Fine day. Night, storm. SW by W.
 Rain and mist. SW by W.
 Slight rain. SW.
 Bright morn, and fine day. S.
 Wet day. S.
 Showers of sleet. Var.
 Rain and great storm. SW.
 Bright morn, and fine day. Var.
 Showery. E.
 A fine day. E.

January, 1817.

1. Cumulus and Cirroscumulus. SW.
2. A fine day. Cumulus. W.
3. A fine day. Cumulus. W.
4. Morn, incessant rain. WSW.
5. Dark, with showers. W by S.
6. Fine day. Clouds various. W by S.
7. Fine day. Cumulus. WNW.
8. Fine day. Cumulus. WSW.
9. Fine. Cumulus, Cirrocumulus. WSW.
10. Hazy, with a little rain. SW by W.
11. Cumulus and Cirrocumulus. W.
12. Cumulus and Cirrocumulus. W.
13. Morn, rain. Eve dark. WNW.
14. Morn fine. Eve, snow. W.
15. Fine day. Cumulus. NE.
16. Morn, sleet. Eve fair. W.
17. Dark, with frequent showers. WSW.
18. A fine day. Cumulus. SW.
19. A fine day. Cumulus. SW.
20. Nearly incessant rain. W.
21. Fair morn. Eve, showers. Var.
22. Hazy, with a few showers. W.
23. Hazy, with a few showers. SW.
24. Hazy, with a few showers. SW.
25. A fine day. Clouds various. SW.
26. Dark, with constant rain. SW.
27. Fine. Cloudless day. SW.
28. Dark, with showers in morn. SW.
29. Fine. Cirrostratus. W.
30. Fine. Cirrostratus. W.
31. Dark. WSW.

- Some showers. SW.
 Some showers. SW.
 Some showers. SW.
 Fine. S and Var. after W.
 Fine. Changed from SSW to W by S.
 Fine. W by N.
 Fine. WSW.
 Fine. S by E.
 Fine. S by E.
 Fine. S by W.
 Fine. Var.
 Fine. W by S.
 A little rain. W by S.
 Fine. W by S.
 Some snow. NE, N, NW.
 Snow: afterwards rain. W.
 Fine, after light rain. S, Var.
 Fine, after light rain. SW.
 Wet day. SE.
 A little rain. W.
 Fine day. Night stormy. SW.
 Day fine. Eve, rain. S by W.
 Day fine. Eve, rain. SW.
 Day fine. Eve, rain. SW.
 Day fine. Eve, rain. SW.
 Little rain. Cloudy. S.
 Fine. S by E.
 Very hazy. W.
 Very fine. W by S.
 Very fine. W.
 Very fine. W.

February.

1. Rather dark. Cumulus. WNW.
2. Dark, with fog. WSW.
3. Hazy, with slight showers. WSW.

- Fine bright day. W.
 Fine, but cloudy. W.
 Fine, and bright. Night stormy. S.

February.

MALONE HOUSE.

4. Blowing hard, with snow. WSW.
5. Cirrostratus. Rain in evening. NW.
6. Hazy, with squalls and snow. WSW.
7. Squally, with showers. WSW.
8. Squally, with showers. WSW.
9. Gloomy weather. WSW.
10. Constant rain. NE.
11. Blowing hard, with rain. W by N.
12. Fine. Blowing fresh. NW by N.
13. Showers. Blowing hard. SW by W.
14. Snow, rain, sleet. Blowing hard. Var.
15. Showers. Blowing very hard. SW.
16. Blowing fresh, with lightning. SW.
17. Blowing fresh, with lightning. WSW.
18. Blowing fresh, with lightning. WSW.
19. Showery, with lightning. Var.
20. Showers of snow, and lightning. Var.
21. Constant snow and sleet. WNW.
22. A shower at noon. NW by N.
23. Blowing hard, with showers. NW by N.
24. Fine morn. Eve, showers. NW.
25. Fine morn. Eve, showers. WSW.
26. Blowing fresh, with showers. WNW.
27. Storm. Thunder, lightning, rain. NW.
28. Dark, with showers. WNW.

DUBLIN.

- Showery. Night fair. S.
 Morn fair. Eve, rain. WSW.
 A very little rain. WSW.
 Fine day. Blowing night. WSW.
 Day fair. Eve and night wet. WSW.
 Very fine. WSW.
 Morn fair. Eve, heavy rain. WSW.
 Showery. Stormy night. WNW.
 Day fine. Eve wet. WNW.
 Wet morn and eve. SW.
 Morn bright. Night wet. W by N.
 Strong wind and showers. SW.
 Fair. WSW.
 Fair. S.
 Fair day. Wet night. S by W.
 Fair day. Wet night. S by W.
 Showers. W by S.
 Showers of hail and rain. SW.
 A fine day. W by N.
 Morn cloudy. Eve, rain. W by N.
 Fair. W by N.
 Rain at night. SW.
 Storm, with thunder. W by N.
 Cloudy. W by N.
 Fair. W by N.

March.

1. Squally, with hail and rain. W.
2. Snow, rain. Blowing very hard. SSE.
3. Heavy showers. Blowing a rank storm. SW.
4. Showers of snow, lying $2\frac{1}{2}$ in. WNW.
5. Fine morn. Showers in eve. WNW.
6. Fine morn. Showers in eve. W.
7. Dark, with showers of snow. WNW.
8. Severe showers of snow and hail. NW.
9. Blowing fresh, with snow. NW.
10. A fine day. WNW.
11. A fine day. Cumulus. WNW.
12. A fine day. Cumulus. NW by W.
13. A fine day. Cumulus. NW by W.
14. A fine day. Cumulus. SW.
15. Fine, with a few drops of rain. SSW.
16. Fine. Eve, a little rain. SSW.
17. A fine day. Cumulus. NNW.
18. Dark. Eve, blowing fresh. SW.
19. Squally, with hail and snow. NW.
20. Squally, with hail and snow. N.

- Fine. S.
 Cloudy. Showers and wind. S.
 Cloudy. Showers and wind. S.
 Bright, with showers. W.
 Bright, with showers. SW.
 Cloudy. Showers and hail. W.
 Bright. Cirrus. A shower. W.
 Bright. Some showers. W.
 Bright. Some showers. NW.
 Bright. A shower. W.
 Cloudy morn. Stormy night. SSW.
 Hazy morn. W.
 Hazy morn. Fair day. W by S.
 Grey morn. Fair day. SSE.
 Very fine day. SW.
 Cloudy, but fair. SW.
 Fair day. SE.
 Morn, Stratus. Day fine. E.
 Cirrocumulus. Hail, snow. WSW.
 Day fine. Snow at night. WSW.

ARTICLE IV.

On the Cells and Combs of Bees. By Dr. Barclay.

(To Dr. Thomson.)

MY DEAR SIR,

In your April number of the *Annals of Philosophy* I see two letters of Mr. R. W. Barchard on the cells and combs of bees and

wasps. In the first of these letters Mr. Barchard observes, that he has been for some length of time in the habit of keeping bees, to which he has paid great attention, and considers it very much against the general economy of the bee to suppose they should bestow the time and pains in making separate, *i. e.* double partitions, when single ones would suffice, particularly as bees appear to enjoy every thing in common.

From this mode of reasoning, were the matter to be settled merely by hypothesis or verbal discussion, would not his opponent be entitled to argue that as bees are so sparing of their time and pains, it must also be very much against their general economy to construct a separate cell for each ovum or egg, as one large cell might suffice, particularly as they appear to enjoy every thing in common. Birds, quadrupeds, and by far the greatest number of insects, find one apartment perfectly sufficient for all the members of their young families; why should not bees, if so very sparing of their time and pains, be equally economical? If not, perhaps their industry and passion for labour, which induce them to construct a separate cell for each ovum, may also incline them to construct a double partition between each cell.

In my notice concerning the combs of bees and of wasps, published in the first part of the second volume of the *Wernerian Transactions*, a notice to which Mr. Barchard alludes, I merely stated what appeared to be the fact, and what, on repeatedly breaking several pieces of bee and of wasp comb before the Society, appeared to be the fact to every gentleman who happened to be present. As the combs, however, appeared to be old, had seemingly contained a young brood, and had even been for some time exposed to the weather, Mr. Barchard infers that what we took for a part of the partition was a thin web which the young brood had left in the cell, and which was afterwards stuck to its sides. Had this been the case, the partition, instead of appearing double, should have appeared triple at least; and if each cell had twice contained brood, the partition should then have been five fold. And indeed Mr. Barchard says that they may sometimes be divided into several leaves, one of the conclusions that necessarily follows from his hypothesis.

Yet he made an experiment to support his conclusion, though he happened to forget it when he wrote his first letter. Now, from making the experiment, I should infer that he entertained some doubts about the foundation on which his conclusion rested; and from his forgetting to mention this experiment in his first letter, that he had still less confidence in his experiment than in his hypothesis. Nor is it to be wondered at. His experiment was this. He melted a quantity of virgin comb in hot water, below the boiling point, and it left no residuum. And afterwards a quantity of old comb, which once had brood in it, and it left a residuum. Of the cause of these different results, he finds an explanation in his hypothesis, that the original partitions between the cells are single, and

appear double only from the webs attached to their sides. It is not impossible that this may be the fact; but certainly neither his reasonings nor experiment are in the least calculated to prove it. As for the experiment, who would ever think of melting down the materials of a watch to ascertain what had been its structure.

If Mr. Barchard should ever be inclined to resume his inquiries, I should wish him to proceed, without any hypothesis, to direct observation and to varied experiment, and to try, among other things, what particular effects a shorter or longer exposure to the weather would produce upon virgin or young comb. I am happy to think that the subject has already engaged his attention; and if he prosecute it by minute and patient investigation, he may be assured that I shall readily and willingly adopt any conclusion that comes warranted upon the genuine principles of induction.

And am, my dear Sir, yours truly,

Edinburgh, April 28, 1817.

JOHN BARCLAY.

ARTICLE V.

Account of different Currents of Wind observed at the same Time.
By Thomas Lauder Dick, Esq. F.R.S. Edin.

(To Dr. Thomson.)

SIR,

Relugas, May 27, 1817.

IN the course of my ride the other day, I was very much struck with a beautiful, and very singular manifestation, of the existence of opposite currents of wind at different altitudes, which I have endeavoured to represent accurately in the subjoined sketch. (Plate LXIX.) Some furze on an eminence, at several miles distance, had been set on fire, and the smoke, after curling upwards, was caught by the under stream of wind, and carried seaward, in a direction from east to west. After having been driven for several miles towards this quarter of the sky, by gently and gradually rising in its progress, it came at last within the influence of a counter current, at a higher elevation, blowing directly from west to east, which drove it back at an angle so very acute as to resemble the sharpened point of an arrow, and presenting the formal and mechanical appearance I have represented; defining almost mathematically the line which separated the two opposite, or upper and under streams, from one another, and which is marked in the sketch by the dotted line, *a, b*. This upper current was evidently blowing stronger than that beneath it; for in defiance of the natural buoyancy of the smoke, it was compelled to proceed in its new direction, with much less deviation from the horizontal line than it had done in the former. It was, therefore, retained longer under the dominion of the new power to which it was subjected. But,



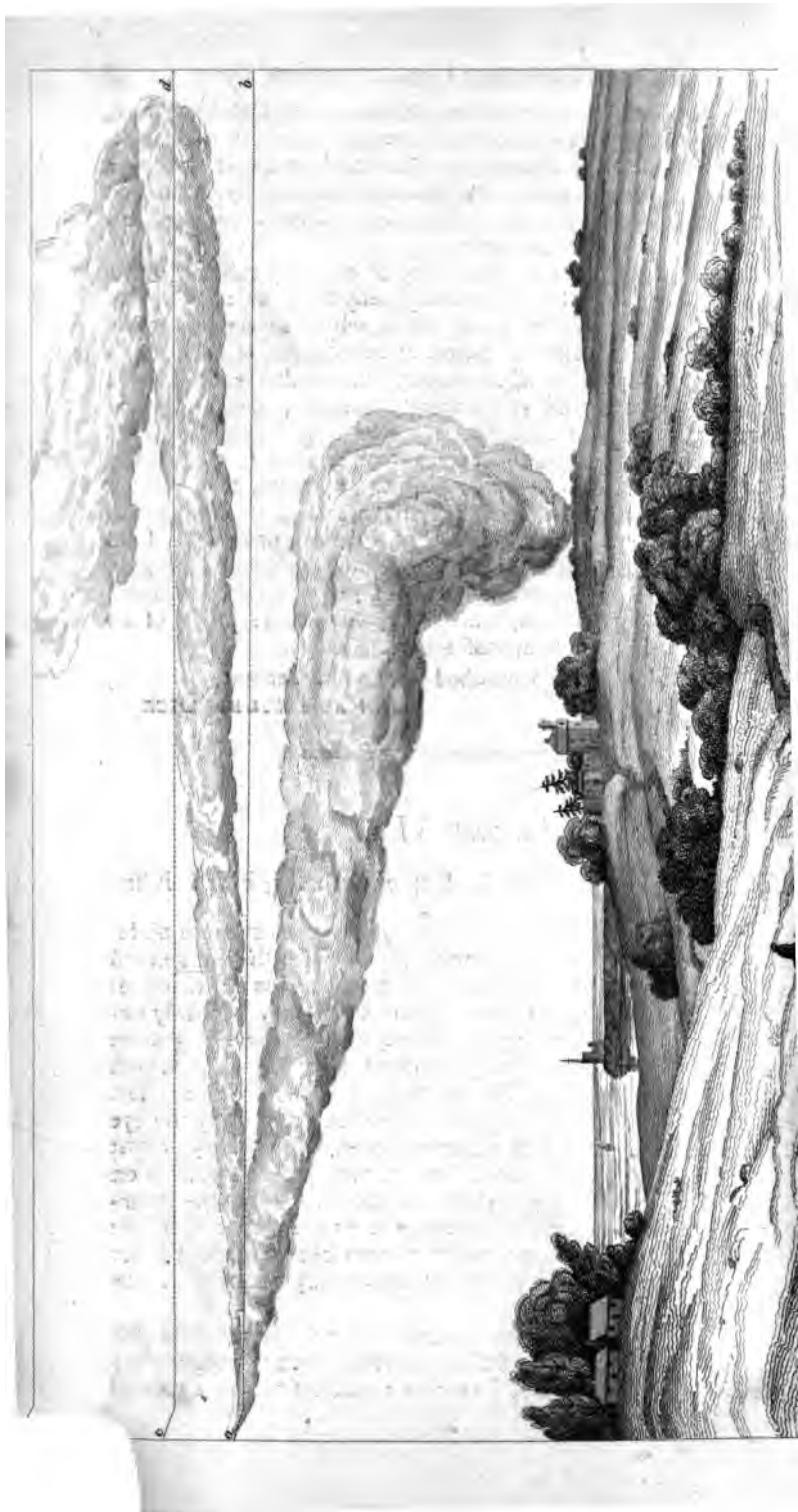

rising gradually at last beyond this, and above the dotted line *c d*, it was assailed by a new current proceeding from the south-east, which carried it, though apparently with less violence, an immense way towards the north-west, until it was at last entirely dissipated. The sky was every where clear at the time, and there was a perfect calm near the surface of the earth.

Many facts illustrative of the theory of contrary currents of air might perhaps be collected by kindling daily fires, on some gentle eminence, in the middle of a vast plain, whilst several observers should be stationed at different points and elevations, to record their various observations on the appearance of the smoke, at stated and simultaneous periods, and afterwards to compare these carefully together. But the obvious difficulties attending the arrangement of such a series of experiments would at once seem to destroy any hope of realizing them. It may happen, however, that what I have here accidentally remarked, may induce some of your readers who may happen to live in the vicinity of a smoke, proceeding from a fire continually kept up for the purposes of some manufacture, in a situation favourable for such investigation, to establish and record a set of curious observations, which may afterwards prove of no mean importance in the science of atmospherology.

I am, Sir, your obedient humble servant,
 THOMAS LAUDER DICK.

ARTICLE VI.

On Vision. By John Campbell, Esq. of Carbrook, F.R.S Edin.

AFTER the abortive labours of so many of our most acute philosophers, and the desponding conclusion to which they in general have come, an attempt to explain the phenomenon of vision as connected with the mode of affecting the nerve may probably expose the person who makes it to the imputation of something more than temerity. Were we to judge, indeed, from the hopeless tone of acquiescence with which Dr. Reid, and, still more lately, Dr. Paley, state the hypothesis that the information received by the eye is communicated by means of pictures formed on the retina, whilst they acknowledge that the mode in which these pictures operate on the organ is altogether inexplicable, we would infer that the investigation of the subject ought in prudence to be abandoned. In this respect, accordingly, it seems really to have been abandoned, for the theory of the pictures is almost universally received as the established law of vision.

Unappalled by these circumstances, but not insensible to the warning they suggest, or the diffidence with which it becomes me to dissent from such opinions, I venture to submit to you a view of

the nature of sight, as far as the mode of affecting the nerve is concerned, which appears to me to explain, in a simple and satisfactory manner, the various phenomena connected with it; and which has this recommendation also, that it develops a unity of principle among all the senses.

It can scarcely be necessary to premise that it is not my intention to enter into any discussion of the question, how the information received by the eye is communicated to the mind. That, indeed, would be a hopeless investigation. Although we know, perhaps, as much of mind as we know of matter, yet as we cannot comprehend modes of action which are not analogous to those which have fallen under the observation of our senses, we can form no conception of its structure or operating principle. We have not, therefore, any one datum on which to found even an hypothesis concerning the mode in which mind reciprocally acts and is acted upon by matter.

Every thing we observe, in contemplating the human frame, leads to the conclusion that the nerves are the immediate agents which convey information to the mind, and transfuse or excite the living energies throughout the body. Beyond this conclusion, applied to some portion of matter (if the nerves be not that portion), we cannot go; and, therefore, all that we can expect from the most successful physiological research is to obtain an intelligible explanation of the problem how the different organs by which sensations are excited are adapted to produce on the nerves which are ramified upon them an affection somewhat corresponding to the information to be communicated. In the senses of smell and taste, for example, the knowledge to be attained by them is quite unconnected with the appearance or dimensions of the body submitted to examination. What is wanted is to determine the nature of the ingredients of which a body is composed, in order that, if fit for the purpose of nourishment, it may be consigned to the appropriate vessels for converting it to use; and if discovered to be unfit for that purpose, that it may be rejected at the threshold. The arrangement of the organs of smell and taste, accordingly, are palpably adapted to the attainment of that end. The olfactory and gustatory nerves by which they are lined receive into contact minute particles of the substances to be examined, and the varied excitements produced by the immediate action of these particles on the respective nerves communicate at once to the mind all the information relative to the substances themselves which these organs were formed to obtain. Few objections have been offered to the common explanation of the mode in which the sensations are excited by these two organs; unless, indeed, we turn aside to consider those wild speculations which, assimilating all the impressions on the mind to the impressions we see and feel to be made on matter, would dethrone the soul, and degrade man to a level with the brutes that perish. In consequence of these dreams, many difficulties have been started regarding the sensations produced by these, as well as the other organs of sense; but these difficulties all relate to the nature of the sensations them-

selves, not to the manner in which they are excited. When we have been endowed with new faculties, faculties capable of dissecting and of analyzing the mind, of understanding the constitution and the fabric of spirit, then, and then only, will it cease to be a waste of time and of talent to engage in the pursuit of such subtilities. It must be much more useful and satisfactory to confine our inquiries to those operations which can be made the subject of observation, and intelligibly explain the mode in which matter acts on matter, in order to produce those effects, the existence of which we know, but for the connexion of which with their cause we can look alone to the fiat of creative wisdom.

As we proceed to those organs formed for more extensive and more complicated application, greater difficulties are supposed to present themselves; and when arrived at the seat of vision, at that delicate instrument which enables man to traverse the heavens, and to distinguish and appreciate the minute and countless varieties which fill up the ample space over which it expatiates, the philosophers seem to imagine that something vastly more complicated must be found in its constitution; and, equally unable to find any marks of such intricate machinery in the eye, or to believe that the wondrous effects produced by its action can be produced by causes simple as those which produce sensation in the more limited organs, the inquiry has been given up as hopeless.

A discovery interesting in itself, and highly esteemed by all late writers on the subject, and which indeed is referred to as of itself affording a demonstration of the theory of sight, has in my opinion been one of the chief causes of our general ignorance. "The sagacious Kepler," says Dr. Reid, "first made the noble discovery that distinct but inverted pictures of visible objects are formed upon the retina by the rays of light coming from the object," the rays, after being refracted by the cornea and crystalline, meeting in one point of the retina, and there "painting the colour of that point of the object from which they come."

Having thus assumed the fact of the existence of a picture on the retina, it was concluded that this picture must be instrumental in communicating the information received. An insuperable difficulty, however, immediately occurred, for no one could even conjecture how these pictures could in any degree produce the effect. Our celebrated philosopher already quoted, Dr. Reid, after noticing some of the conjectures upon the subject, and their unsoundness, expresses himself in several passages as follows: "Nor is there any probability," says he, "that the mind perceives the pictures on the retina. These pictures are no more objects of our perception than the brain is, or the optic nerve."* Since the picture upon the retina, therefore, is neither itself seen by the mind, nor produces any impression upon the brain or sensorium which is seen by the

* Inquiry into the Human Mind, 4th edit. p. 256.

mind, nor makes any impression upon the mind that resembles the object, it may be still asked, how this picture upon the retina causes vision.* "In answer," Dr. Reid observes, "we must resolve this solely into a law of our constitution. We may form such pictures, by means of optical glasses, upon the hand, or upon any other part of the body, but they are not felt, nor do they produce any thing like vision. A picture on the retina is as little felt as one upon the hand, but it produces vision, for no other reason, that we know, but because it is destined by the wisdom of nature to this purpose." † This is rather a sovereign mode of disposing of the difficulty, and applicable only to first principles; but as there could be found no trace, either in the structure of the parts, or in the analogy of their functions, to explain the province of these pictures, there remained no alternative. "It is evident," says the Doctor, "that the pictures upon the retina are by the laws of nature a mean of vision, but in what way they accomplish their end we are totally ignorant." ‡ §

* Inquiry into the Human Mind, 4th edit. p. 257. † P. 262. ‡ P. 254.

§ I should have thought it hardly possible that, to any one who had listened to these quotations, it could have remained doubtful whether Dr. Reid meant, by the pictures which he considered to be a mean of vision, the assemblage of rays of light as they pass through the retina, or reflected pictures, according to the ordinary meaning of the term, not passing through, but painted on, that portion of the nerve. As, however, some members of the Royal Society of Edinburgh did, when the paper was read, express a decided opinion that Dr. Reid had given precisely the same view of the subject that I have done, it seems necessary, in defence against such respectable opponents, to prove somewhat more at large what really was Dr. Reid's opinion. In doing this, it is unnecessary to enter into any disputation about the application of the term picture to a determinate assemblage of rays; not reflected, but passing through a transparent body. I am of opinion that such application of the term is improper; but that is of little moment; for as to the theory of pictures, as explained by Dr. Reid, there can be no doubt that the pictures they refer to are *reflected pictures*, and therefore with theirs at least my views can have no accordance. In one of the quotations inserted in this paper Dr. Reid says we may form *such pictures* by means of optical glasses on the hand. Can any one doubt that the Doctor here means a common reflected picture, not passing through the hand, but painted on its surface. The uniform expression of a picture painted on the retina affords proof equally conclusive. Had he referred to the assemblage of rays passing through the retina, he never would have called these a picture on the retina, but a picture in it, or *passing through* it. In what other sense than that of a reflected picture can we understand the following language: "Of all the organs of sense, the eye only, as far as we can discover, forms any kind of image of its object, and the *images formed by the eye* are not in the brain, but only in the bottom of the eye." (P. 256.) "By what law of nature is a *picture upon the retina* the means or occasion of my seeing an external object of the same figure and colour in a contrary position, and in a certain direction from the eye." (P. 260.) "Perhaps some readers will imagine that it is easier to conceive a law of nature by which we shall always see objects in the place in which they are, and in their true position, without having recourse to *images on the retina*. To this I answer, that nothing can be a law of nature which is contrary to fact." Not to multiply quotations too much, I only add one more: "We conclude that our seeing an object in that particular direction in which we do see it is not owing to any law of nature by which we are made to see it in the direction of the rays, either before their refraction in the eye, or after, but to a law of our nature by which we see the object in the direction of the right line that passeth from *the picture of the object upon the retina* to the centre of the eye."

It certainly requires some hardihood to attack these formidable pictures; but I feel bold enough to denounce them as mere phantoms. I deny that any picture is painted on the human retina; and even in those animals whose nocturnal pursuits, requiring peculiar organization, have obtained for them a structure which will produce a picture (not on the retina, however, but on the choroides): it will, I trust, be made evident that the picture in these cases is but a passive accompaniment, not an active instrument in the production of sight. Nothing is to me more surprising than the universal and unhesitating credence that has been given to a supposition, which has never, and never could be, verified; but which, on the contrary, is in direct opposition to facts demonstrated, and inrolled amongst the fundamental principles of science. Dr. Reid, who seems to have felt doubtings upon the subject, states, with truth, "No man ever saw the pictures in his own eye, nor indeed the pictures in the eye of another, until it was taken out of the head and duly prepared." It was this passage which excited my scepticism; and I hesitated not to reject the hypothetical fact altogether, when I found that the Doctor ought not to have made any exception in his statement, no man having ever seen, or being able to see these pictures in the eye of another, more than in his own; for the preparation alluded to, and which does produce the capability of showing a picture, changes the subject of it from an eye to something else, to an instrument as different from an eye as a window is from a reflecting mirror,

What then is the evidence of the existence of these pictures? It is this: that if an eye be taken, and the sclerotic and choroid coats being removed, a piece of white paper, or any white substance, fitted to reflect the rays of light, be substituted for the retina, or placed behind it, then the picture of any object held opposite to the pupil will be seen distinctly painted on the paper. This is the demonstration on which the whole hypothesis is founded; and on examination it will appear palpably deficient in every quality of evidence to prove the conclusions drawn from it.

What is a picture? It is the reflection of the rays of light under

(P. 269.) I trust it is now manifest (for in the last passage the picture and the assemblage of rays are contrasted) that Dr. Reid's theory does introduce real reflected pictures painted on the retina. Indeed, so completely did Dr. Paley adopt this idea, that he compares the eye to a *reflecting* telescope, the images of the objects being painted in the same manner on both.

I have to make one remark more. Even were it still maintained that Dr. Reid means pictures passing through the retina; and were that point yielded, little would be gained; for certainly Dr. Reid acknowledges that he is altogether unacquainted with the mode by which these pictures become a mean of vision. He has not ventured a conjecture on the subject, but resolves it, as the only resource, into a law of nature. It therefore remains to be shown how a theory which denies the existence of any pictures painted on the retina, and which offers an explanation (be it good or bad) of the mode in which the rays affect the optic nerve so as to afford the varied perceptions of dimension, figure, and colour, can be so identified with Dr. Reid's opinion, for he has no theory, as to differ only by a change of terms.

such an arrangement as to correspond exactly with the different parts of the body which the picture is intended to represent. The essential properties, therefore, of an instrument for reflecting pictures must be, first, that the rays emanating from the original shall be collected, so that they may impinge on the reflector in accurate, distinct, and corresponding figures and colours; and, secondly, that when they thus reach the focus where the image is to be painted, there be there a proper reflector to send all the rays back again, to produce in the spectator the perceptions of a picture. The first of these qualifications, that for refracting and concentrating the rays, the natural and the prepared eye both possess. These are the functions of the aqueous and the crystalline humours; and about the nature or extent of these functions there is no dispute. With regard to the second qualification, however, there is a most material difference between the natural eye and the eye prepared for this demonstration. In the natural eye there is no reflector. The retina itself is nearly, if not quite, transparent. In proof of this we have only to remember that the black appearance which distinguishes the pupil proceeds from the choroides which lies behind the retina; and that the retina is so transparent as not even to raise a cloud on the intensity of the black mantle behind it.* But if the retina be really so transparent, it can be no reflector. There is the same difference between the retina and the white paper that distinguishes a piece of common glass from a steel speculum. What is demonstrated by the one can afford no conclusion as to the other. They are, in fact, in opposition to each other. A speculum in a telescope will show the picture of an object within the field of the instrument; but substitute for it a piece of transparent glass, and the picture vanishes; the rays, instead of being reflected, are transmitted. Let it not be said that, even in this case, the picture would be formed in the glass, though it would not be visible; for a picture does not exist by the mere assemblage of those rays, which, if reflected, would exhibit a picture. It is the reflection, and not the assemblage, which calls the picture into being; for if the rays be not reflected, but they pass on to the eye, then we see, not a picture, but the body itself. It is evident, then, that the retina of the natural eye

* It may perhaps be objected that, although the retina be sufficiently transparent fully to bear out the argument against the pictures, it is not so transparent as here represented. Even when the eye is taken warm from the head of an animal, the transparency is found to be imperfect. In this case I beg to refer the decision to the eye in the living body, where unquestionably the transparency of the retina is so great as to render it invisible. Even in cases of hydrocephalus, when the pupil is so distended as to admit a considerable portion of light, and the retina remains invisible; and, according to my judgment, a more perfect transparency can scarcely be conceived than that which prevents us from perceiving, notwithstanding all the different membranes and liquors which intervene, that the black coating of the choroides is not situated on the external surface of the eye. I apprehend that the transparency of the eye diminishes much on the extinction of the vital energy; and, therefore, that the removal of it even from a living body would not afford a fair testimony, or such as could weigh at all against the evidence afforded by the living eye itself.

does not reflect a picture in the manner in which it is reflected by the paper in the prepared state; and if there be demonstration in the case, it is a demonstration that the retina cannot possibly reflect a picture at all.

But it has been said by Dr. Priestley and others that, though no picture is formed on the retina, it is formed on the coat behind it—the choroides. A dilemma immediately occurred on this assumption sufficient to have startled the most hardy philosophers. By thus transferring the picture from the retina to the choroides, the optic nerve was discarded as an instrument of vision; for the retina is in fact the optic nerve. The transparency of that membrane, however, afforded too palpable an obstacle to its being considered capable of reflecting; and therefore these philosophers conceived that, as a picture must be found somewhere, and it could not be formed on the retina, it might be formed behind it. The difficulty, however, was equally insurmountable; for, to wave the manifest absurdity of excluding the optic nerve from the theory of vision, it is evident that the choroides is as incapable as the retina of reflecting objects so as to form a picture. The choroides at this part in many animals, as in man, is black—a pure black. Now why is it black? Is it not because it does *not* reflect the rays of light? Although it is black, or rather dark, before it absorbs any rays, it is not because it is dark that it does absorb them, but it is because it does absorb them that we perceive that it is black. Whatever, therefore, may be thought of the reflecting powers of the cat, the owl, and other animals which seek their prey in comparative darkness, clear it is that, with regard to the human eye, no picture can be formed either on the retina or choroides. By the one all the rays of light are transmitted; by the other, they are all absorbed.

Liberated from the trammels of this paralyzing phantom, let us compare the perceptions which the eye is fitted to produce with the perceptions produced by the action of the kindred organs.

With regard to the anatomy of these parts, it is unnecessary for me to say much. The structure of the eye is generally known, and can scarcely be mistaken. Suffice it to observe that, after passing through the ball of the eye, and being collected, and concentrated in their passage, the rays of light impinge on the retina, which is the extremity of the optic nerve, reticulated on a thin membrane, and which forms a transparent screen, through which these rays are transmitted to the choroides, where they are all immediately absorbed. Our present inquiry is limited to the operation of the rays on the retina; for, as they afford no perception of vision previously to reaching that point, and are all absorbed by the choroides immediately on passing through it, the single question is, how can these rays affect the retina so as to produce vision?

Vision is composed of two things: the perception of figure or dimension; and the perception of colour. These are so distinct and unconnected with each other, that they ought to be reckoned different senses. There is certainly much less distinctive difference be-

tween smell and taste than between figure and colour. They have been united merely because they are produced by the same organs, and combine together to procure correct information from visible figure. In considering the origin of these perceptions, however, we must separate them. The perception of figure and dimension by the eye is evidently analogous to the perception of these qualities of matter by the organ of touch: the discrimination of colour, again, is more analogous to the discrimination of smell.

It will be useful to premise some observations on the mode in which perceptions are generated by the organ of touch. If we admit the nerves to be the media of communication, and observe the close texture of their ramifications over the whole surface of the body immediately under the skin, and particularly the profusion of their minute branches extended over the hands and feet, we can have little difficulty in conceiving how the idea of dimension may be communicated by this organ. The extremities of these nerves are most minutely divided; no one, it is believed, having yet been able to trace them to their terminations; but each of them, even the minutest branch, must be considered as a separate nerve, capable by itself of communicating an intimation of its own excitement. Hence if any point of the body be forcibly touched, the locality of that point is immediately perceived. It were vain to stop to prove that we at once distinguish the neck from the heel, or the hand from the shoulder. No one ever heard of a person mistaking the gout for the tooth-ache, or a box on the ear for a kick on the shin bone. How the nerves give that information to the mind is not the question; that we cannot comprehend: but holding it to be a law of our constitution that the nerves do in some way or other communicate to the mind the sensations excited in the different organs, we may with some hope of success inquire, how the objects of the different senses act upon the organs, and excite the nerves; and finding, on inspection, that the nerves of the organ of touch extend their fibres in distinct branches over the surface of the body, we perceive that the individual sensation excited by the action of any of these branches exhibits a capability and fitness for communicating to the mind certain notices of all such bodies as are applied to them, and thus we easily comprehend how they indicate locality. But if they indicate locality as to one point, they must equally do so as to all the points which may be touched; and, therefore, if a considerable portion or area be compressed by touch, the extent of nerves thus affected must be equally perceived. Alongside of each other there must *somewhere* be two branches—one compressed, and the other free; and the communication of this difference, and of its locality, must be immediately and distinctly made. The information, indeed, that one or more branches of nerves are affected, and that others adjoining are not affected, must be simultaneously communicated. But the perception of this difference, and its locality, is the perception of dimension and figure. For our *idea of dimension is, the extending over two or more points instead*

of one; and our idea of figure is, that one area of the compressed nerve differs from another area. When the body examined is too large to have its whole figure contained in one impression, a blind man first ascertains the extremities, and then passes his hand over the space which lies between them.* Experience, however, enables the blind to shorten this process; † and, by putting their elbows close to their sides, they calculate pretty accurately from the position of the fore arms and hands what is the size of a body placed between them. In this case the information is obtained by introducing the knowledge of the distance between the arms and hands previously acquired. But originally it is evident that to acquire a knowledge of the dimensions of a body larger than the hand, it would be necessary to apply the hand repeatedly, so as to obtain by these repeated applications a compression of an area of nerves equal to the surface of the object of examination. By this operation, however, we can easily apprehend how the ideas of dimension and figure are produced by touch. We no doubt often experience sensations, the localities of which we cannot precisely distinguish. After the amputation of a limb, a man sometimes complains of pain in that part which is severed from the body, and lies buried in the earth; but these are the effects of a diseased state of the nerves, and of fixed associations of ideas, and can militate nothing against the general position, that the nerves intimate the locality of those affections they communicate.

I conclude, then, that if I take a body two inches long, and press it with my fingers, I shall perceive the extent of the pressure, because I shall perceive where the pressure ends. And if one half of that body be cut away, I shall also perceive this diminution of extent. Dr. Reid seems to question this, and to state his opinion: that the connexion between the sensation of touch and the idea of extension is inexplicable. ‡ Were this scepticism confined to the

* There is a beautiful provision made for preserving the continuity of feeling. The digital branches of the medial nerve send each two smaller branches—not to the same finger, but one to each of two adjoining fingers; so that a channel of communication is thus opened, the importance of which may be at once appreciated by crossing the fingers, and applying a small body to them in that position. The communication being destroyed, the perception is of two bodies instead of one.

† Any one may see this practically illustrated by visiting the Asylum for the blind, and observing the movements of the workmen. I was struck with the use the blind men made of the little finger. When they wished to obtain precise information of the nature of a surface, they applied to it the little finger. An attention to the structure of the hand explains this. The little finger and one half of the ring finger are supplied with nervous energy by the ulnar nerve; the remainder of the fingers, and the thumb, by the medial nerve. By their hard fingering and thumbing in the execution of their basket work, they blunted the sensibility of the nerves ramified on the thumb and three fingers; but the little finger being exempted from such influence, and being supplied by a separate nerve, its sensibility remains, and becomes the most delicate instrument in their hands for obtaining information by touch.

‡ “The notion of extension,” says the Doctor, “is so familiar to us from infancy, and so constantly obtruded by every thing we see and feel, that we are apt to think it obvious how it comes into the mind; but upon a narrower examination, we shall find it utterly inexplicable.” (P. 121.)—“Suppose,” in the case

nature and mode of the communication between mind and matter, we should, as before explained, readily agree with Dr. Reid; for there can be few in the present day, and in the face of his triumphant argument on that point, who will still contend for any resemblance between the sensation and the idea produced by it. But in as far as he maintains that we cannot in any view understand how the organ of touch should communicate information of dimension, I cannot but dissent. It is sufficiently clear that no idea of relative dimension could be communicated in any case, without having some standard to determine the relation; but I think it is equally impossible to deny that this blind man, when he touched a circular body, would necessarily perceive a difference between the sensation then produced from that produced by touching a body which was square or triangular. This would arise from the compressed area of the nerve being in the one case circular, and the other square. In like manner he must necessarily perceive the difference between a larger and a lesser body, between a whole and a half. It is true he might not, as in the case supposed, be able to compare any of these bodies or the areas of the nerves affected by them, with the area of his own body, or with that part of the body generally alluded to in stating dimensions—the foot; but he would compare them with each other, and would know that one was larger or smaller than another, or that they were nearly equal; and what, as to dimension, can the most acute and learned philosopher know, but that one body is larger or smaller, or equal, to another body? The correspondence, then, between the dimensions of a body which is touched and the dimensions of the area of the nerve which is compressed being complete, although we may admit without hesitation that the idea of a circle is no more like a circle than it is like justice or courage, yet we easily apprehend how the nerve receiving the exact impress of these qualities of bodies should in that way, by which the nerves do communicate information to the mind, communicate the various impressions which it has thus received.

But what is all this to the eye? As to dimension and figure it is every thing; for I apprehend that the very same principles govern both organs; and that the sensation which gives the idea of dimension and figure is produced in the eye in consequence of similar excitements of the retina; not, indeed, by the body itself, as in the sense of touch, but by the particles of light reflected by it, and which pass through an area of the retina exactly corresponding to the visible figure of the body. It is here the picture forms a useful ally. It demonstrates that the rays pass through the retina in the determinate form, and with the same distribution of colours, which characterise the object from which they proceeded. The optic nerve, therefore, must be excited in different portions, greater or

of a blind man with no previous knowledge of extension, “that a body applied to him touches a larger or a lesser part of his body. Can this give him any notion of its extension or dimensions? To me it seems impossible it should, unless he had some previous notions of the dimensions and figure of his own body.” (P. 127.)

less, round or square, or angular, exactly as the figure of the object surveyed by the eye is greater or less, or round or square, or angular. As soon, therefore, as we believe that a nerve is an instrument which, by some means or other, inexplicable to us, does communicate to the mind the impressions made upon it, we cannot surely be in much difficulty to conceive that it should distinctly communicate the fact, that only one portion of it has been excited, or that a larger or smaller portion has been excited, or that a portion peculiarly excited in one part of the area differs in extent from another portion differently excited, and in another part of the area. It is impossible to conceive any distinct idea arising from sensation, unless it shall extend to these particulars; and if it be granted that the sensations are thus fitted to convey information as to the areas excited, then we ask no more to explain the mode in which a sensation indicative of dimension is produced on the optic nerve. An area of that nerve spread out to form the retina is excited exactly corresponding to the visible figure of every body which forms an object of sight.

But this explanation reaches only to one of the qualifications of the eye. There remains to be considered the discrimination of colour. A few observations will suffice on this point, because somewhat of the same reasoning leads us to what is at least a plausible solution of that problem also.

The idea of colour is in some respects analogous to that of smell and taste. We cannot understand why the peculiar affection produced by a particle of matter should produce an idea of sourness, or sweetness, or sharpness, or poignancy. These are particular ideas which arise in consequence of information being conveyed to the mind that the nerves have been affected in several particular ways; and they are ideas connected with these particular affections by the original laws of our constitution. The ideas of colour, of scarlet; blue, or yellow, are of the same nature. They are perceived when the optic nerve communicates information to the mind that it has been excited in the various ways by which the red, and blue, and yellow rays of light do actually affect it. These rays are in their nature different from each other, and therefore each of them must produce an affection peculiar to itself. When we recollect, then, that each of these coloured particles, passing through the retina in the precise relative arrangement in which they proceed from the body under examination, must produce the affection peculiar to itself, and that on the point of the area which corresponds to its situation in the object seen, we may understand how we not only perceive the extension and figure of that object, but also its various colours and shades; and thus, as far as such theories can go, we obtain an intelligible theory of vision.

I have mentioned that in the eyes of some animals pictures may really be formed, the coating of the choroides behind the retina being white and resplendent. This provision is suited to the habits of those animals which seek their prey in the dark, and the object

of it seems to be to aid the weak impressions made by the luminous rays which are but scantily emitted or reflected during the night. To man, to the hawk, and to all those animals whose activity is chiefly exercised in the light of day, and to whom it is of most importance to have distinct vision amidst a flood of light, the covering behind the retina is lined with a substance which absorbs the rays after they have passed through that membrane, so that none of them can return to confuse the original impression by a second excitement. On the other hand, the nocturnal prowlers are not concerned so much about distinct vision as to obtain by it a knowledge of the locality of their prey, at a time when it supposes itself in safety. The rays being then in small numbers, the excitement of the nerve must be less acute; but by placing behind it a reflecting instead of an absorbing coat, the rays may be sent back, and by an arrangement of the parts for that purpose, may be returned in the same direction, and thus double the intensity of the excitement. From this view of the final cause, why the colour of the choroides in such animals is white I would conjecture that their eyes, and particularly the parts at the retina and choroides, which are opposite the pupil, are shaped differently from the corresponding parts of the human eye; and that in their structure there is a provision for reflecting the particles of light in the same direction in which they originally passed through the retina.

The solution which I have now ventured to propose does indeed banish from the problem of vision much of its complexity; but it increases rather than impairs its peculiar fitness for that which is the most legitimate and satisfactory object of scientific research—the illustration of the attributes of him who hath conjoined in the mechanism of the eye so much simplicity and such ample power. Unlike the feeble efforts of man, where the causes must be many, though the effects be few, the works of God show multiplied and varied effects produced by a few simple causes. The excitements produced by the rays of light passing through this diminutive screen communicate to the human mind by much the greatest portion of all that varied, extensive, and interesting knowledge, which man can acquire of the material creation. It is true we learn by the sense of touch to appreciate the effects of light and shade, so as to understand from the *visible* what is the *real* figure of an object; and we learn still more from experience to draw inferences from circumstances which at first convey no precise idea to the mind. But that does not at all affect the proposition that it is by the eye chiefly we connect ourselves with the world without us, or that its organization is adapted to the acquisition of all these different kinds of knowledge. A man often employs a valuable machine long before he discovers or applies all its capabilities; but whether these can be employed with or without a combination with other machinery, or whether they can be all brought into action at the outset, or require repeated practice to enable the possessor to draw from them all the advantages they afford, still the construction of a machine which in such

circumstances can ultimately be so extensively employed carries evidence that power, and wisdom, and design, adequate to all these varied ultimate effects, were exerted in that construction. Such is the view in which we ought to contemplate the eye; and when we so contemplate its structure, and its powers; the simplicity of the arrangement of its parts, and the analogy between it and the other organs of sensation; its adaptation to near as well as distant objects;* the rich and varied treasures of information, for usefulness, and for enjoyment, which it explores and appreciates; and the indication of mind, of intelligence, and affection, which it so expressively reciprocates; we cannot fail to perceive that, were this organ alone submitted to our observation, it would itself demonstrate that it must have been formed by an intelligent Being, and that the Being who formed it must be possessed of infinite power, and wisdom, and goodness. It would demonstrate more, and what is of more immediate importance to us, for it follows as a corollary that God has put forth into active exertion all these attributes to promote the happiness of his creature man.

ARTICLE VII.

Method of preserving Volatile and Deliquescent Substances.

By Dr. Dewar, F.R.S. Edin.

(To Dr. Thomson.)

SIR,

Edinburgh, May 11, 1817.

EVERY person concerned in chemical operations must have experienced inconvenience from the difficulty of retaining volatile, deliquescent, and efflorescent substances in a state of perfect preservation. Lagrange directs that no volatile acid should stand in that department of a laboratory which is appropriated to the more delicate experiments. Though the stopper of a phial be ever so well ground, it yields to the expansion of the contained substance, occasioned by slight elevations of temperature. In hot climates ether is generally kept in stopped bottles immersed in water in an inverted state; and I believe it will seldom be found that water long thus employed is entirely free from an impregnation of the ether.

For obviating these inconveniences, I beg leave to propose the following expedient:—Let every bottle intended for such substances have a circular rim round its shoulder, not rising quite so high as the mouth of the bottle. In the cavity formed by this rim let a quantity of mercury be contained, and let an inverted glass cup,

* The grey drone fly is said to have 14,000 eyes, and the dragon fly a great many more; but how imperfect is the information obtained by these vast aggregates of visual orbs compared to the information communicated by the pair bestowed on man.

the mouth of which is adapted to the cavity, be immersed in the mercury covering the stopper and neck of the bottle. The cup, from its lightness compared to the mercury, and from the resistance opposed by the air contained in it, is prevented from sinking to a sufficient depth. The bottom of it, therefore, may be loaded with a flat piece of metal cemented to it. When put on, it should be pressed down, and held a little on one side, for the expulsion of a small part of the air. This pure object may be obtained to any requisite degree by gently warming the cup.

It is scarcely necessary to enumerate the advantages which will arise from the adoption of this plan. Volatile acids may stand in any room without in the least endangering the polish of fine metallic surfaces, or affecting the progress of delicate experiments. Those who wish to preserve deliquescent substances in a dry state, as, for example, muriate of lime, or soil which powerfully attracts humidity (substances which, from their cleanliness, are preferable to sulphuric acid for the formation of ice by the process invented by Professor Leslie), may keep them in bottles of this kind.

They may also be employed for the preservation of certain minerals, such as extraneous fossils of pyrites, and the lomonite, or mealy zeolite, the preservation of which has occasioned so much unsatisfactory trouble to mineralogists.

A similar apparatus may be used for retaining anatomical preparations in spirits, both for preventing more effectually the evaporation of the spirits, and affording greater facility in taking out the preparations at pleasure.

The apparatus will be more perfectly understood by an inspection of the annexed figure: A represents the body of the phial: B, B, compartment for mercury: C, C, C, cup inverted in mercury, to keep the phial air-tight; within this are represented the neck and stopper.

When the contents of the bottle are wanted, we take off the cup, and, holding the stopper with the finger, begin with pouring out the mercury into the cup, now standing upright on a table.

It might be rendered more carriageable by means of a circle of cork passing between the inverted cup and the containing rim; and still more so by a piece of leather or of bladder tied over the whole, a circular groove being made on the outside of the rim for retaining the string, and the interior surface of the bladder might be smeared with a tenacious substance for confining the mercury. This would contribute to the perfection of the apparatus, if used at sea. But for standing in a room, it will require no such addition, and will then be of itself much more convenient, cleanly, and secure, than the usual expedient of ground stoppers covered with lute.

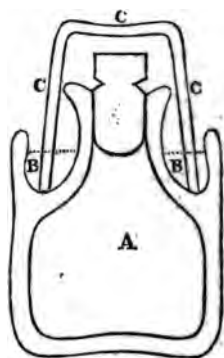

Before concluding, I shall observe that the same principle may be advantageously employed in the construction of domestic implements for preventing the escape of the offensive effluvia of excrementitious substances in the bedchambers of the sick. Pieces of furniture have indeed been made for accomplishing this purpose by means of water used exactly in the same way. But the relative properties of water to the effluvia alluded to are such that these have been justly complained of as ineffectual.

I am, Sir, your most obedient servant,

HENRY DEWAR.

ARTICLE VIII.

*Report made by M. Poisson of a Memoir by M. Hachette respecting the Running of Liquids through small Orifices, and with Pipes applied to these Orifices.**

THE experiments of M. Hachette may be divided into three parts. The object of the first is to measure the contraction of the fluid vein proceeding from a narrow aperture. The second examines the cause of the singular phenomena which take place when small cylindrical or conical pipes are added. In the third part the author describes the figure of the fluid vein, and the variations occasioned by different forms of the orifice. We shall not attempt to explain all the importance of these different questions, either in practice, or as they relate to the theory of the motion of liquids; but, without further preface, we shall give an analysis of the three parts of the memoir subjected to our examination by the Class.

PART I.—*Contraction of the Fluid Vein.*

The author examines, in the first place, if the figure of the small orifice has any influence on the quantity of liquid that flows out in a given time. It is generally admitted that, supposing the pressure the same, and the orifice unaltered, the quantity of liquid which flows out is not changed. M. Hachette determines the correctness of this principle when the orifice is circular, triangular, elliptical, or formed of an arch of a circle and two straight lines. But he finds the products very different, either in excess or defect, when the contour of the surface presents re-entering angles, which occasions an important modification in the principle which we have mentioned. If the plane in which it is pierced be not horizontal, the fluid vein forms a curve, which ought to be a parabola corresponding to a certain initial velocity which the author has determined by direct measurement. Setting out from the place of greatest contraction, the thickness becomes constant for a considerable extent;

* This memoir was read to the Royal Academy of Sciences, Dec. 18, 1816.

namely, till the jet, by mixing with the air, loses its shape. In this extent all the fluid molecules describe the same curve, and the vein resembles perfectly pure crystal, supposed immoveable. It was, therefore, easy to measure the abscissæ and the ordinates of different points of the same jet; and by a comparison of these measures the author has recognized that the fluid curve does not deviate sensibly from a parabola. He has concluded, likewise, from the known formulas of parabolic motion, the velocity of the fluid in a given point, for example, at the place of greatest contraction. He has found in this manner that the common velocity at all the points of the contracted section is very nearly that derived from the height of the surface above the orifice. Thus the theory of Torricelli is accurate when applied to the velocity that takes place at this section of the vein; but it cannot be true, at the same time, with respect to the mean velocity of the molecules which traverse the section of the orifice on account of the difference between the areas of these two sections.

The velocity at the contracted section being known, the observation of the expanse of fluid in a given time will make us acquainted with the ratio of this section to that of the orifice, or with what is called the quantity of contraction, more exactly than can be done by direct measurement. The time is to be reckoned, and the quantity of liquid that flows out from a small orifice under a constant pressure is to be measured. At the same time, the quantity of liquid that ought to be discharged by the orifice is to be calculated by the rule of Torricelli. The ratio between the observed and calculated discharge will be a fraction which will express the quantity of contraction. This method, pointed out by D. Bernoulli, has been followed by M. Hachette. He neglected none of the precautions necessary to diminish the errors of experiment. He measured the time by means of a second watch of M. Breguet. The orifices which he employed were constructed and measured by M. Lenoir. By inspecting a communicating tube, he was always sure that the level of the fluid did not vary during the experiment; and, finally, his observations were made on a very large scale both with respect to the size of the vessel and the volume of water that flowed out, and likewise with respect to the time during which the liquid was flowing out, which sometimes amounted to more than an hour. A table placed at the end of his memoir gives the result of 28 experiments made in this manner on heights of water between 135 and 888 millimetres (5.315 and 34.96 inches), and with orifices varying from 1 to 43.3 millimetres (0.03937 to 1.626 inch). The smallest contraction observed by the author corresponds to the smallest diameter. It is 0.78. For diameters above 10 millimetres (0.3937 inch) the contraction becomes almost constant. It lies between 0.60 and 0.63. When the orifice remains the same, it increases a little with the height of the fluid; but it does not appear to depend upon the direction of the jet.

Other philosophers who have determined the contraction of the

vein differ from each other respecting its greatness. Newton, for example, considers it as 0·70; Borda found it 0·61; and in a certain case he found the area of the contracted vein reduced to almost one-half of the area of the orifice. No doubt this difference between such skilful observers ought to be partly ascribed to the size of the orifices, and to the pressures employed. But M. Hachette points out another cause which D. Bernoulli had already perceived, and which ought to have a notable influence on the quantity of contraction deduced from the waste of fluid observed. This cause is the form of the surface in which the orifice is pierced. According to M. Hachette, the waste of fluid (every thing else being the same) is the smallest when the surface in contact with the fluid is convex. It increases when the surface becomes plane, and still more when it becomes concave. Accordingly he observed that the waste varied about a twentieth part when the copper disc containing the orifice, and which is plane on one side, and a little concave on the other, was simply turned.

M. Hachette proposes to continue his experiments on the flow of water through small orifices, varying all the circumstances which can have any influence on the flow in a given time, and endeavouring to find the laws of their influence. He proposes, likewise, to extend them to cylindrical vessels, emptied by great horizontal orifices. In that case the time of flowing out can no longer be determined by the theorem of Torricelli, which supposes the orifice very small. Its rigorous expression depends in each case on two transcendental quantities of the kind which Lagrange named functions *gamma*, and of which he has given very long tables in his *Exercises on the Integral Calculus*. By means of these tables we may calculate the time of flowing through an orifice whose diameter is any fraction whatever of that of the cylinder. This will enable us to compare theory with observation in this very important point of view.

PART II.—*Increase of the Flow by Cylindrical or Conical Tubes.*

This phenomenon was known to the Romans, though they were doubtless unable to appreciate it exactly. At the beginning of the 18th century, Poleni, Professor at Pavia, gave the measure of it in a very simple case, that of a cylindrical pipe of a length equal to about three times the diameter of the orifice. He showed that in that case the flow is increased one-third; so that if it amounts to 100 when the orifice is thin, it becomes 133 in the same time by the addition of the pipe. In a work published in 1797, M. Venturi, of Modena, has shown that by employing a pipe composed of a cylinder of a certain length, terminated by two cones whose dimensions he determined, the flow may be increased in the ratio of 12 to 5, or almost to $1\frac{1}{2}$ times as much as when the orifice is thin; and it does not appear that this philosopher obtained the maximum effect of which the pipes are capable; for M. Clement has been able to increase the flow considerably by changing the form of the

apparatus of Venturi. These experiments, those which are given in the Hydrodynamics of D. Bernoulli, and those of many other philosophers whose names we shall not mention here, have put the phenomenon of pipes beyond all doubt. It is equally certain that this increase is owing to the liquid flowing in a full stream in the tube, which causes the contraction of the vein to disappear, and even changes it into a dilatation when the pipe is conical. But hitherto it has not been explained in a satisfactory manner why the fluid thus fills the tube adapted to a thin orifice. M. Hachette finds the sole, or at least the principal cause of it, in the adhesion of the fluid to the sides of the tube; that is to say, in the force which produces the capillary, and other similar phenomena.* The following are the experiments made to confirm this proposition:—

EXPER. I.—The fluid in motion was mercury; the pipe was iron. When the mercury was perfectly pure, it had no affinity for the iron, and flowed out as it would have done had there been no pipe. But when the mercury was covered with a pellicle formed of an alloy of tin and other metals, this alloy covered the inside of the pipe, and in that case the mercury flowed in a full stream.

EXPER. II.—The fluid was water; the pipe was coated within with wax. The pipe was not filled, and the water flowed as if no pipe had been present. But it is always possible to force the water to moisten the wax; then the water fills the pipe, owing to the wax being replaced by the first coat of water which covers it. Hence the reason why a disc of glass at last adheres to water with the same force, whether or not it be covered with a coating of wax; for as soon as the wax is wetted, it is merely the action of water on water which determines the phenomenon, as M. Laplace has explained it in the theory of capillary action.

Another no less important fact, which M. Hachette has determined, is, that in a vacuum, or in air rarified to a certain degree, the phenomenon of pipes ceases to take place.† Thus having made

* *Opinion of former Writers on the Cause of the Effects produced by Tubes.*—M. Venturi states in a note (p. 23) that Gravesende and others have ascribed to the natural cohesion of the particles of water the increase of expanse in the additional descending tubes, and he observes that this cause is of very little importance. Before him, Bussut, Dubuat, had explained the effect of pipes by the viscosity of the water, the resistance of the fluid contained in the pipes, and the obliquity of the jets which strike the sides. At this time the phenomena of capillary tubes were scarcely known, and till now they had not been distinguished in the movement of fluids, which belongs to mechanics properly so called. Accordingly M. Bossut himself thought it requisite to adopt an hypothesis different from his own, presented by Venturi, as we see by the conclusion of a report made to the Institute on Sept. 7, 1797.—H. C.

† *On the Flowing of Liquids in a Vacuum.*—This experiment must not be confounded with the one related in p. 15 of the work of M. Venturi. This philosopher says that, after having placed upon the receiver of an air-pump in which the mercury in the gauge stood at ten lines of height, a vessel to which a cylindrical pipe was fitted, he had observed that the time which the level of the liquid in the vessel took to sink was the same as if the experiment had been made in the open air, and by an orifice without a pipe, and of the same diameter as the pipe.

This fact being admitted, Venturi thought that he ought to ascribe the cause of the effects produced by the pipes to the action of the medium in which the experi-

water run in a full stream through a tube under the receiver of an air-pump, and having rarified the air in the receiver, the author observed the fluid vein detaching itself from the sides of the pipe when the internal pressure was reduced to 23 centimetres of mercury, the external pressure being 0·76 metre. By thus diminishing the internal pressure, the effect of the external pressure is increased, which is transmitted to the pipe by means of the fluid contained in the vessel, and to which is added the pressure of that fluid. But there comes a point at which these two pressures are sufficiently great to detach the fluid vein from the sides of the pipe; in the same manner as a sufficient force detaches a disc from the surface of a fluid to which it adhered.*

Thus the flowing out of water in a vacuum or in rarified air agrees perfectly with the proposition of M. Hachette; and does not prove, as might be supposed, that the phenomena of pipes are owing to the pressure of the air in which that fluid flows—an opinion which would be obviously inconsistent with the two experiments just cited; for in these experiments the action of the air was the same, and yet the phenomena were different, according to the nature of the fluid and the matter of which the pipe was composed.

When the fluid vein has been detached by rarifying the air as we have just stated, if we allow the air to enter again into the receiver, M. Hachette has observed that the water does not again begin to flow in a full stream. The contraction of the vein which took place in the rarified air continues to subsist, though the pressure of the atmosphere be restored. This, in the author's opinion, leads to the conclusion that the adhesion of that fluid to the sides of the pipe takes place only at the commencement of the motion, before that the fluid has acquired a sensible velocity in a direction which separates it from the side. To verify this conjecture, M. Hachette made the following experiment, which is the last that we shall notice:—

The water flowed in a full stream through a pipe without the receiver of an air-pump. A small hole was made in this pipe very near the orifice. The external air then entered into the pipe, as ought to have happened according to the theory† of D. Bernoulli.

ment takes place. He did not remark that the contact of the liquid and of the sides of the pipe must precede the issuing out of the water, in order that it may run out from a full pipe. I have ascertained several times that the running of the liquid from a thin orifice, or from pipes, does not vary sensibly, whatever be the medium which surrounds the vessel, and that the liquid will run out in a full stream through a conical pipe with a maximum of divergence in a vacuum as well as in the open air.—H. C.

* I repeated the same experiment in atmospheric air. The fluid vein was not detached from the sides of the pipe but under a pressure of a column of water, whose vertical height was 22·8 metres; so that the difference between the superior and inferior pressure was (22·8 — 10·33) 12·47 centimetres in water, or 91 centimetres in mercury. The conduit of water not being vertical, we can draw no conclusion respecting the real pressure of the column of water in motion. I am preparing an apparatus to determine the point.—H. C.

† *Measure of the Negative Pressure in a Conical Pipe.*—According to this theory (of Bernoulli), the sides of the conical pipe experience during the flowing of the

It interposed itself between the water and the sides of the pipe. The contraction of the vein takes place in the inside of the tube, and the water ceases to flow in a full stream. This being the case, the opening made was exactly shut: the adhesion of the water and pipe was not again produced, and the flowing of the water continued as if the pipe had not existed, so that it might have been removed or replaced without any change in the flow of the water. This experiment succeeded equally whatever was the direction of the jet. But care must be taken not to agitate the apparatus; for a very small lateral motion of the fluid vein causes it to adhere again to the moist sides of the pipe. It was probably from having neglected this precaution that M. Venturi, in p. 13 of his work, gives a result which appears contrary to that of M. Hachette.

PART III.—*Figure of the Fluid Vein.*

We have but little to say respecting this third part, which belongs entirely to descriptive geometry. It is in it that M. Hachette has been chiefly aided by two fellow labourers, who assisted him in his experiments, M. Girard, Draughtsman to the Polytechnic School, and M. Olivier, formerly a pupil in that school, and at present an officer of artillery. We find in it a description of the different forms of fluid vein corresponding to certain figures of the orifice. Figures upon a large scale representing the curve of the vein, and some of its sections, accompany the memoir. These figures have been constructed by a method sufficiently exact, which it would be difficult and superfluous to explain.

In this analysis of the memoir of M. Hachette we have pointed out most of the new experiments which belong to him, both respecting the contraction of the vein, and on the phenomenon of pipes; and we have stated the theory to which these experiments have led him. The Class may perceive by this statement what the author has added to the discoveries of his predecessors in this important branch of the mechanics of fluids, and be enabled to judge at the same time how much remains for him to do in order to com-

liquid in a full stream an internal pressure less than the external pressure of the atmosphere. I measured the difference of these two pressures, which I call *negative pressure*, by means of a glass tube with two parallel vertical branches bent in the lower part. One of these branches was curved in its upper part, to fit it to the sides of the tube. Having first put mercury in the tube, the curved branch was filled with water, so that the water of that branch communicated directly with that which flowed through the conical pipe. The mercury rose in that branch during the flow of the liquid with a constant level, and I concluded that the height of the column of water which measured the difference of the pressures corresponded nearly to the initial height of the velocity which the water acquires in the conical pipe at the point of the insertion of the tube into this pipe. This result does not agree with the proposition of M. Venturi (p. 16 of his work). On that account I repeated the experiment several times; and I do not think that I am deceived in the conclusion which I have drawn from it. According to M. Venturi, the water would assume at the point of the insertion of the tube a velocity measured by the negative pressure augmented by the height of the constant level above the orifice. I must remark, however, that the result of his 15th experiment (p. 27) confirms my conclusion.—H. C.

plete the investigation which he has begun. We think that in engaging M. Hachette to continue his labours, the Class ought to approve of this memoir, and order the printing of it in the *Recueil des Savans Etrangers*.

(Signed) AMPERE, GIRARD, and POISSON,
Commissioners.

Feb. 5, 1816.

The Class approves of the report, and adopts its conclusions.

Observations on the Method of obtaining a constant Discharge from a given Orifice, and on the Changes in the Quantity of the Liquid discharged which results from Obstacles placed at small Distances from the Orifice.

M. Hachette has communicated his observations to the meeting of the *Société Philomatique* of Feb. 10, 1816. They are a continuation of the memoir on which M. Poisson has written the preceding report. We shall extract from it what relates to obstacles struck by the fluid vein at small distances from the orifice.

D. Bernoulli thought that these obstacles did not change the quantity of fluid that flowed out; and he mentions in the fourth section of his *Hydrodynamics* an experiment in support of his opinion; but the flow lasted too short a time to deduce from it an exact comparison between the quantities of liquid that flowed out. The influence of the obstacle is very obvious in the following experiment:—

A fluid vein flowed out of a great vessel by a circular horizontal orifice 20 millimetres in diameter, and fell into a vessel placed at a great distance from the orifice. The level of the water in the vessel sank about six decimetres in 10' 21". The plane face of an obstacle was presented at different distances from the orifice on which the jet fell perpendicularly.

These distances, expressed in millimetres, being

128^m 80^m 50^m 24^m 4^m

the corresponding times of the sinking of the level are

10' 21" 10' 25" 10' 26" 11' 13" 15' 54"

This shows us that at the distance of 128 millimetres (5·039 inches) the obstacle produces no effect; but at four millimetres (0·157 inch) the time is increased rather more than one half.

ARTICLE IX,

Determination of the primitive Form of Bitartrate of Potash.

By W. Hyde Wollaston, M.D. F.R.S.

(To Dr. Thomson.)

MY DEAR SIR,

March 26, 1817.

I YESTERDAY took up again the examination of the form of supertartrate of potash; and as I found it by far the most difficult

ever undertook to investigate, I am unwilling that the share of labour bestowed upon it should be lost, and commit it to writing without delay.

Imagine a prism the section of which is a rectangle, having its sides nearly as 8 to 11. Let it be terminated at each end by dihedral summits placed transversely, so that the sides of one summit meet in one diagonal, and the sides of the opposite meet in the other at an angle of $79\frac{1}{2}^\circ$. You have then a form to which all the modifications of this salt may be referred, and from which they may be calculated.

But, though this be a convenient *primary* form for consideration of the subject, it may perhaps not be correctly the *primitive* form, since all the faces that I have named cannot be obtained by fracture. The prism splits most readily in the direction of its broader side, without difficulty in the direction of its diagonals, with some difficulty in the direction of its narrow side, but not at all in the direction of those faces which I have represented as terminal.

It might, therefore, be regarded as a rhombic prism, which also splits in its two diagonals, terminated by dihedral summits arising from its *sides* (instead of its angle), and transversely placed as before.

But of these views I prefer the former, on account of a third view of the matter (which, indeed, is the first I had of the subject). You have but to conceive the former prism shortened till the sides are reduced to nothing, and the summits will then comprise a scalene tetrahedron, the sides of which are four similar triangles, inclined to one another at $79\frac{1}{2}^\circ$, 77° , and $53\frac{1}{2}^\circ$.

Conceive this tetrahedron moved in the direction of its shortest diagonal, it describes the first prism, and the splits of that prism are in the planes described by all the edges of the tetrahedron.

I will inclose a model unfolded, which you may easily reunite by warming the cement at the corners.

Yours very faithfully,

W. H. WOLLASTON.

ARTICLE X.

Appendix to the Essay on the Chemical Compounds of Azote and Oxygen. By John Dalton.

(Read to the Manchester Society, December, 1816.)

I. *Experiments on the Combination of Nitrous Gas and Oxygen, with a View to ascertain the Maximum and Minimum.*

CLASS I.—*Experiments over Water.*

EVERY attentive observer must have seen with surprise the variable proportions in which nitrous gas and oxygen unite. Whether

the nitrous is put to the oxygen, or the oxygen to the nitrous gas, is of very considerable influence; the dimensions of the eudiometric tube, the quantities and proportions of the gases mixed, the duration of the experiment, and many other circumstances, influence the results in such a degree that sometimes two experiments made every way alike are found to differ in their results. No one, as far as I know, has attempted to account for these surprising irregularities. I have had as much experience with mixtures of nitrous gas and oxygen as most chemists, and have succeeded pretty well in satisfying myself as to the causes which modify the proportions: I shall now offer my explanation.

Gay-Lussac has observed in his late essay that no more than three compounds of nitrous gas and oxygen are requisite to account for the variations observed. Now, though there certainly may be an intermediate compound between the two extremes, yet as all the varieties in the proportions may be formed out of the two extremes of nitric acid and subnitrous acid, the existence of an intermediate acid should not be admitted without demonstration. I shall, therefore, wave the use of *nitrous acid vapour* in my explanation of the phenomena, at least as exhibited over water.

All experience seems to show that the presence or proximity of water favours the formation of subnitrous acid, and the absence of water is favourable to the formation of nitric acid. Hence the necessity of a narrow tube when the last is to be formed; this diminishes the surface of the water, and removes the point of junction of the two gases from the said surface: but another circumstance is requisite to procure nitric acid; namely, that the nitrous gas be put into the tube first; for in this case the acid formed, seizing the water on the side of the tube, gradually trickles down, and is exposed to the lower stratum, or oxygen, by which means it gets saturated with it. Due care must be taken, too, that the oxygen be in great excess; otherwise the liquid acid formed reaches the water before it gets saturated with oxygen. For a like reason it will appear why the oxygen must be put in first, and an excess of nitrous gas after, when we want to form subnitrous acid.

When an excess of nitrous gas is put to oxygen in a wide vessel, so that the two gases form a stratum of about $\frac{1}{4}$ inch in depth, subnitrous acid is chiefly formed, owing, as it seems to me, from the liberal and instant supply of water or steam to the new formed acid. Yet this circumstance is adverse in one respect, as the water removes part of the *nitric acid* formed out of the sphere of action of the nitrous gas before it has time to get saturated. Hence it is seldom that we find more than three nitrous united to one oxygen this way. In some recent trials I have procured subnitrous acid more completely by using a narrow tube with oxygen at top, and an excess of nitrous gas beneath; but this mode requires a long time before the experiment is finished, as will be stated below.

In all mixtures of nitrous gas and oxygen in a narrow tube, but

particularly where an excess of nitrous gas is added to oxygen, there are two periods of combination—the quick and the slow. The quick one usually lasts about one minute, after which all visible motion ceases, and the slow period commences; this lasts usually one day: if the diminution in the first period be denoted by four, that in the second sometimes amounts to three. This subsequent diminution was observed by Dr. Priestley, and doubtless by others, but no cause has been assigned that I have seen. I find that the quick period ceases as soon as one of the two gases is exhausted, but not before. Thus if a large portion of nitrous gas be put to a small one of oxygen, and in one minute, or as soon as the motion of the water has apparently ceased, the residuary gas be transferred, there is no oxygen found in it, and no further diminution ensues; whereas if it had remained in the original tube for 24 hours, the diminution would have been almost doubled. It is evident, therefore, that the two gases combine in one minute, forming nitric acid chiefly in all probability; but if this nitric acid combined with the moisture within the tube be subsequently exposed to the remaining nitrous gas, it slowly imbibes it, and forms subnitrous acid. In like manner, by changing the circumstances, subnitrous acid is slowly converted into nitric acid; but the time and quantity of diminution are much less in this case.

In performing experiments with nitrous gas over water, the effects of transferring the gas, and of suffering it to remain over water for 24 hours, more or less, are not to be neglected. The gas is subject to a loss by both these circumstances. I find that 100 measures of gas, one half nitrous, in my eudiometers, which are six or eight inches long, and $\frac{3}{10}$ wide, lose two or three measures per day by standing over water. The same quantity of pure nitrous gas loses one or two per cent. upon each transfer through water. It is evident from these remarks that violent agitation of nitrous gas mixtures over water must be disallowed, as giving fallacious results.

In order to obtain the combination with a minimum of nitrous gas, a small portion of pure nitrous gas, or, which answers better in my experience, a dilution of nitrous gas with azote, must be put into a narrow eudiometer (because this has more surface in proportion to retain the new formed acid): to this a large portion of oxygen gas must be added, and the mixture remain in the tube for half an hour at least.

I shall now state a selection of experiments to illustrate the different positions suggested above. The results of these experiments do not materially differ from innumerable others that might be given; but it is quite sufficient to give a few experiments of each class:—

. To 54 measures of nitrous gas of 97 per cent. purity = $52\frac{1}{2}$ real
Put 96 oxygen gas containing 43 or 44 real oxygen

150

70 in 3 minutes

60 in 7

60 in 1 hour 30 minutes. Gives 1 oxygen + 1.4 nitrous.

. To 98 oxygen containing 43 real
Put 57 of 97 per cent. nitrous = $55\frac{1}{2}$ real

155

104 in 1 minute

86 in 2

75 in 3

67 in 4

$65\frac{1}{2}$ in 5

65 in 6

$64\frac{1}{2}$ in 13

64 in 30 Gives 1 oxygen + 1.55 nitrous.

. To 26 nitrous 93 per cent. pure = 24.2 real
Put 100 common air = 21 oxygen

126

104 in 2 minutes

91 in 5

86 in 10

85 in 15

85 in 25 Left 4.2 oxygen

85 in 7 hours. Gives 1 oxygen + 1.44 nitrous.

. To 100 air = 21 oxygen
Put 25 of 93 per cent. nitrous = $23\frac{1}{2}$ real

125

102 in 1 minute

95 in 2

92 in 3

90 in 4

89 in 5

$88\frac{1}{2}$ in 10

88 in 20 Left $7\frac{1}{2}$ oxy. Gives 1 oxy. + 1.69 nitrous.

The first and second experiments are alike nearly; as also the third and fourth; but with this exception, that the disposition of the gases on the mixture is inverted. From these we see that whichever gas happens to be the lower is, all other things alike, the most expended; for the reason, it is presumed, already assigned. It

it obvious, too, that in all these examples it is expedient to at least two compounds to be formed.

5. To 16 of 97 per cent. nitrous = 15.5 real
Put 125 oxygen of 60 per cent. = 75 real

141
116 in 1 minute
114 in 4
113 $\frac{1}{4}$ in 12
113 in 37
113 in 2 hours. Gives 1 oxygen + 1.24 nitrous

6. To 25 of 97 nitrous = 24 $\frac{1}{4}$ real
Put 113 oxygen (left in last experiment)

138
97 in 1 minute
96 in 5
96 permanently. Gives 1 oxygen + 1.36 nitrous.

7. To 41 of 28 nitrous = 11.5 real
Put 99 of 49 oxygen = 48 real

140
121 in 2 minutes
120 in 6
119 in 16 stationary. Gives 1 oxygen + 1.21 nit

8. To 59 of 28 nitrous = 16.5 real
Put 119 oxygen (left above)

178
151 in 5 minutes
149 in 10
148 in several hours: contains 26 oxygen by h
Gives 1 oxygen + 1.22 nitrous.

The last four experiments, made in the same tube, are class to exhibit the minimum of nitrous gas: they reduce the quantity much below the general average; but though the quantity of acid is greatly diminished in these instances, I cannot see a sufficient reason why it should be annihilated. No mixtures of this kind, I apprehend, can attain either the minimum or maximum of nitrous gas absolutely, however nearly they may approach these extremes.

To 35 of 72 per cent. oxygen = 25 real
 at 140 of 97 nitrous

175		
110	in	1 minute
105	in	3
101	in	13
100	in	16
95	in	33
92	in	43
89	in	1 hour 20 minutes
85	in	2 30
81	in	3 30
79	in	4 30
79	in	8
68	in	12
61	in	1 day 6 hours. Gives 1 oxygen + 3.56 nitrous.
60	in	2 days.

Here we have the maximum nearly produced in the same tube as minimum, with this difference, that, instead of one hour, it requires 24 to produce the ultimate effect. If the gas in the above experiment had been transferred after one or two minutes, no further diminution would have taken place, and consequently no oxygen would have been found in the residue. Here it should seem that nitric acid is formed first, and condensed by the moisture on the side of the tube; and being very small in quantity, it is prevented from running down a great length of tube, and reaching the surface of the water, till it has been exposed sufficiently to the nitrous gas to be saturated.

If the maximum absorption of nitrous gas by oxygen be wanted, may be readily obtained by the method which I announced in a paper on the absorption of gases by water (read in 1803). Immerse water with a given quantity of oxygen gas, and then saturate the gas with nitrous. I there stated that one measure oxygen requires $3\frac{1}{2}$ of nitrous: since that I have adopted 3.6 nitrous. It is very remarkable that *nitric acid* cannot be formed this way; for if more than 3.6 measures of nitrous be used, a portion of the oxygen is expelled, and found in the residuary gas.

CLASS II.—*Experiments over Mercury.*

No author that I have seen has given any regular series of results obtained by mixing nitrous and oxygen gas over dry mercury. It has been thought that the nitric acid formed, acting upon the mercury, must generate more nitrous gas, and thus induce an error in regard to the proportions combining. I have lately made about 30 experiments of this sort over mercury, as dry as could be made by

blotting paper, and with tubes well dried by rubbing with linen tied round wire. The proportions mixed were of course varied, and the gases more or less diluted with azote. The principal phenomena are related below:—

1. In all cases of mixture of the two gases over mercury, a union quickly takes place, but not quite so rapidly as over water; and fumes appear and continue more or less; the mercury is immediately acted upon; a dead white powder is formed, which adheres to the tube; when water is let in, a solution of the mercurial salt is formed, which yields the black oxide by alkalis, &c.

2. Whatever proportions are mixed together, a rapid diminution first takes place, and afterwards a slow one. In no case did I observe, at any period of the process, a temporary *increase* of the volume, except in one; and as that did not occur again in like circumstances, I conclude it was a mistake. The nitrous gas formed by the mercury is, I believe, retained; but it is efficacious in reducing the oxygen in the sequel, if the oxygen be in excess. Agreeable to this is the well-known fact that cold liquid nitric acid of a certain density gives out no nitrous gas in the solution of mercury.

3. When the oxygen is greatly in excess, one measure of oxygen appears to combine with about 1.05 of nitrous; and when the nitrous is greatly in excess, one of oxygen combines with nearly 1.8 of nitrous gas. In the former case, I apprehend, a part of the oxygen combines with the nitrous gas, adhering to the mercurial salt, so as to make the real combination that of nitric acid, or one to 1.2 nitrous. In the latter case it seems probable that *nitrous acid gas* is formed when one combines with 1.8 nitrous. The great majority of the experiments exhibited combinations of one oxygen with 1.2 or 1.3 of nitrous gas, and that with small residues of oxygen or nitrous gas. In no instance was one oxygen found to combine with so much as two nitrous, except one, when the mixture was transferred over water, about two minutes after the gases were put together, and in all probability before the combination was wholly effected; so that the excess of nitrous gas combined was to be ascribed to the agency of the water.

4. After the diminution appears to be at an end, or nearly so, and the residue is transferred over water, if oxygen be in the residue, no diminution is observed on the transfer; if nitrous be in the residue, a diminution takes place greater or less, as it should seem according to the previous dryness or moisture of the mercury, or to some other unobserved circumstance; but it is probable the whole diminution would take place previously to the transfer, if the experiment were allowed a considerably longer time.

A selection of the experiments follows:—

To $30\frac{1}{2}$ { measures nitrous gas, 96 per cent. pure = 29 real,
 $1\frac{1}{2}$ azote
 Put 58 of 80 per cent. oxygen = $46\frac{1}{2}$ real, $11\frac{1}{2}$ azote

$88\frac{1}{2}$
 $58\frac{1}{2}$ in 1 minute
 $43\frac{1}{2}$ by a little gentle agitation
 $36\frac{1}{2}$ by do. in 9 minutes
 37 18
 32 12 hours
 $31\frac{1}{4}$ 17
 31 24

31 transferred over water, $18\frac{1}{4}$ oxygen by hydrogen

s gives one oxygen to 1.04 nitrous by measure; but no doubt nitrous gas in union with the mercurial salt contributed to re-
 ceive the oxygen.

To 36 of 94 per cent. nitrous = 34 real, 2 azote
 Put 101 of 70 per cent. oxygen = 71 real, 30 azote

137
 $102\frac{1}{2}$ in 1 minute
 96 in 5
 92 in 9
 87 in 12
 78 in 1 hour 8 minutes
 75 in 2 25
 $73\frac{1}{2}$ in 3 10
 72 in 4 25
 72 in 6 30

72 transferred, 40 oxygen by hydrogen.

s gives one oxygen to 1.1 nitrous.

To 100 common air = 21 oxygen, 79 azote
 Put 25 nitrous, 96 per cent. = 24 real, 1 azote

125
 100 in 1 minute
 94 in 5
 88 in 45
 82 in 1 hour
 81 transferred over water, 1 oxygen.

s gives one oxygen to 1.2 nitrous.

In five other experiments with common air the proportions were 1.07, 1 : 1.23, 1 : 1.27, 1 : 1.33, and 1 : 1.52, in each of which there was a small residue of nitrous gas.

4. To 41 of 70 oxygen = 29 real, 12 azote
Put 108 of 93 nitrous = 100 real, 8 azote

149

92 in 1 minute

92 in 5

92 in 8

90 in 18

90 in 36

83 in 2 hours 37 minutes

77 in 3 27

76 in 3 37

71 in 5 0

70 in 6 40

70 in 7 20

69 transferred through water, 49 nitrous by sulphate of iron.

This gives one oxygen to 1.76 nitrous. The result is somewhat anomalous, though I have no doubt as to the accuracy of the observations. In all the other cases, when there was a large residue of nitrous gas, a considerable diminution took place on transferring through water, and less nitrous gas was combined. I suspected the tube or mercury had not been so carefully dried in this experiment as in some others, and therefore made the following experiment, the result of which seemed to confirm the suspicion:—

Having dried the tube well, and heated the mercury to above 212° , when cooled it was poured into the tube, and this was inverted into the trough. Then

5. To 41 of 70 per cent. oxygen = 29 real, 12 azote
Put 107 of $92\frac{1}{2}$ per cent. nitrous = 99 real, 8 azote

148

$95\frac{1}{4}$ in 1 minute

$94\frac{1}{4}$ in 5

$93\frac{1}{4}$ in 12

91 in 45

89 in 12 hours

70 transferred over water, 52 nitrous by sulphate of iron.

This gives one oxygen to 1.655 nitrous

Yet it would seem that by a longer continuance of the experiment, the nitrous vapour would be wholly reduced, as in the following:—

To 49 { of 72 oxygen = 31 real, 12 azote, over well-dried
mercury
at 110 of 93 nitrous = 102 real, 8 azote

153

93 in 1 minute

92 in 4

91 $\frac{1}{2}$ in 12

91 $\frac{1}{4}$ in 55

91 in 2 hours 10 minutes

89 in 8

87 in 10

85 in 11

77 in 23

72 in 27

70 $\frac{1}{2}$ in 28

69 in 35

67 in 47

65 $\frac{1}{2}$ in 59

65 $\frac{1}{2}$ in 3 days, transferred over water, and found to contain 20 azote by sulphate of iron

s gives one oxygen to 1.82 nitrous.

These results may be reconciled to the notion that nitric acid consists of one measure oxygen to 1.2 of nitrous acid; and nitrous of one oxygen and 1.8 nitrous gas: but do not accord so well with the other, namely, that nitric acid is one oxygen with 1.4 nitrous gas; and nitrous acid, one oxygen to two nitrous gas.

(To be continued.)

ARTICLE XI.

description of an Absence Thermometer. By Anthony Semple,
Esq. M.R.I.A.

(To Dr. Thomson.)

DEAR SIR,

HAVING long considered that a good absence barometer was a desideratum in natural philosophy, I have for some time turned my attention to supplying that deficiency, and have at length succeeded, in a manner that (I hope) will meet your approbation, and that of the scientific world in general.

It is with great diffidence that I send you the following description of one that I have lately contrived; but, as it more than answers my expectations, agreeing accurately with a good standard instrument hanging beside it; and as I think it will facilitate the

labours of those who are engaged in meteorological pursuits, I venture to offer it to their consideration, through the medium of your journal.

A tube belonging to a common wheel barometer, having had the usual small bulb at the upper end replaced by a cylinder of large dimensions for a reservoir, is filled with pure mercury, and placed in a case with the recurved part (of about $6\frac{1}{2}$ inches) exactly perpendicular. The superfluous mercury is then drawn out, by means of a glass syphon, until it is as low as the then state of the atmosphere will admit. A steel wire stem of about $5\frac{1}{4}$ inches long is then provided, running through a perforated brass cap, and having a light glass bubble at its lower end; and a thin plate of brass, $1\frac{1}{4}$ inch long, and $\frac{1}{2}$ inch broad, screwed on its upper end, as represented in the drawing [Plate LXX. Fig. 1] (where the working part only is shown). This plate has a small hole drilled close to each end. The bubble, being lowered into the tube, floats on the mercury, and the brass cap keeps out dust, and retains the stem in a perpendicular position. Now it is evident that when the mercury rises in the common barometer, it will fall in this, and *vice versa*. There are two verniers (weighing about 15 gr. each) accurately counterpoised, and hung by a silk thread, passing over pulleys truly turned by a good watchmaker. The silk of the vernier which shows the maximum passes through one of the holes in the brass plate above mentioned. The other vernier has a slender brass wire $1\frac{1}{8}$ inch long, which passes downwards through the other hole. In this arrangement I think it is evident that when the pressure of the atmosphere increases, the bubble will sink, and the brass plate draw down the maximum vernier, which (being counterpoised) remains at the lowest it has been drawn down to. When the pressure of the atmosphere decreases, the minimum vernier will ascend on the brass plate (there being only the mere friction of 30 gr. on nicely made pulleys to overcome), and will remain at the highest it has been lifted to. All this it has done, and continues to do, in the most satisfactory manner; entirely superseding the necessity (for register) of more than one observation in the 24 hours. The only difficulties in the construction are the making of the verniers, and the adjustment of the scale. The former should be light, and must hang exactly perpendicular when suspended (for which purpose there is a small knob of brass at the extremity of the projecting and horizontal part). The scale should be fixed between the two parts of the tube, so that the verniers be *very* near, but not bearing against them. In my instrument the verniers were hung before they were engraved, and an opportunity taken to mark with a steel point the cutting division of each, when the mercury in the standard one was stationary. A small door, with a lock, keeps the apparatus from being meddled with.

Should this instrument meet (as I trust it will) the approbation of the public, it is obvious that an additional scale and vernier may be placed below the present, so as to show the actual state of the

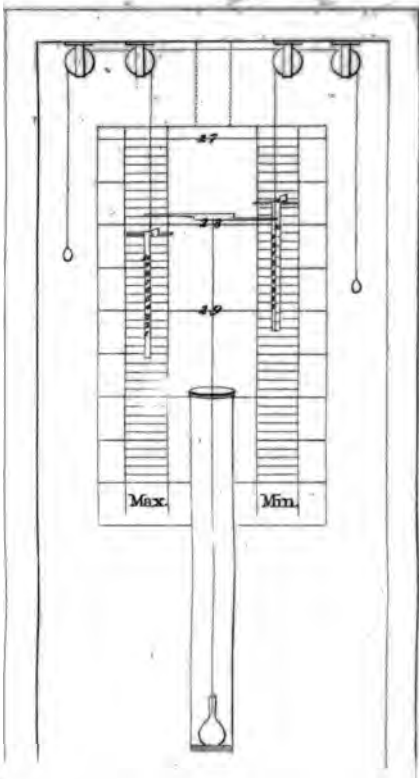

Fig 1.

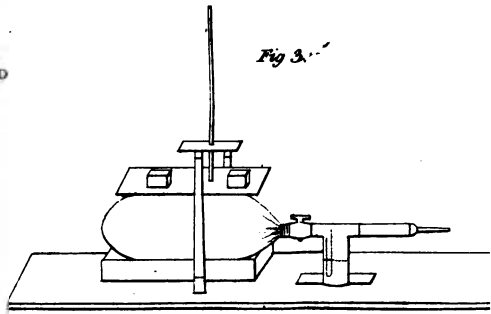
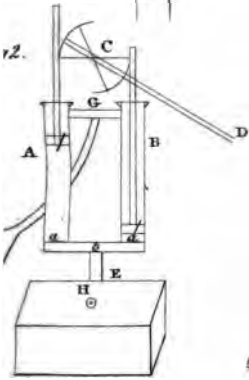

Fig 3.

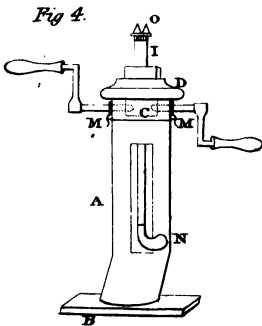

Fig 4.

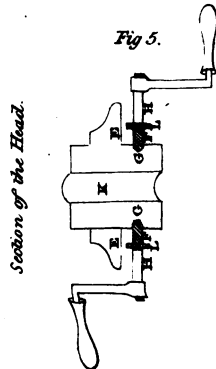

Fig 5.

Section of the Head.



mercury, in its passage, from one vernier to the other. Those who dislike the inverted scale may suspend the verniers, at the other end of the silk, letting them rise and fall on a common scale.

I fear that the accuracy of a floating gauge, to keep the mercury in the reservoir at the same height, is impracticable in this instrument; but by properly proportioning the diameter of the small tube to that of the reservoir, the correction (however small) may be easily made.

Yours very truly,

Malons House, April 11, 1817.

ANTHONY SAMPLE.

ARTICLE XII.

ANALYSES OF BOOKS.

Transactions of the Royal Society of Edinburgh, Vol. VIII. Part I. 1817.

This part contains the following articles:—

1. *On the Action of Transparent Bodies upon the differently coloured Rays of Light.* By David Brewster, LL.D. F.R.S., Lond. and Edin. and F.A.S. Ed.

It is well known that the spectrum of solar light obtained by passing a ray of light through prisms composed of different materials varies in its length. In some the green rays occupy a comparatively greater space, and in others the violet and blue rays the greater. Hence, when two such prisms are combined acting in opposite ways upon light, if we look to the bars of a window through them, we observe fringes of coloured light. These fringes constitute what is called the *secondary spectrum*. The property itself is called the *dispersive power* of the prism. These uncorrected colours constitute the great obstacle to the perfection of the achromatic telescope.

In this paper Dr. Brewster gives an account of experiments to determine the dispersive power of 89 different bodies, both liquid and solid, which he arranges according to their action on green light, those that have the least action being placed first, and those that have the greatest action last. Sulphuric acid was found to have the greatest action, and oil of cassia the least.

I should conceive the results of these trials upon most of the liquid bodies liable to some uncertainty, because their nature varies so much at different times, that we might expect different specimens of the same body to possess different dispersive powers. The acids are given without any specification of their density or purity, so that we are left very much in the dark about them. Thus the *nitrous acid* of the author is probably the fuming acid of the shops, which is very different from real nitrous acid. Prussic acid, when pure, is speedily decomposed; probably, therefore, the prussic acid of the

author is merely water impregnated with a small quantity of that acid. The phosphorous acid is probably a mixture of phosphoric and phosphorous acids and water. The oils are liable to an equal degree of uncertainty. This ambiguity and uncertainty render it doubtful whether achromatic telescopes can ever be effectually improved by means of liquids. The natural crystals afford a much more probable means.

2. *Description of a new Darkening Glass for Solar Observations, which has also the Property of polarizing the whole of the transmitted Light.* By Dr. Brewster.

This contrivance consists in a plate of glass of some thickness, having slips of metal placed upon its opposite faces. An oblique solar ray enters the glass plate, and is prevented from reaching the eye by the slip of metal on the eye side of the glass. It is reflected back through the plate to the slip of metal on the other side, and being again reflected back, passes to the eye much attenuated.

3. *Observations on the Fire-damp of Coal-mines; with a Plan for lighting Mines, so as to guard against its Explosion.* By John Murray, M.D. F.R.S. E.

Published in the *Annals of Philosophy*, vol. viii. p. 406.

4. *On the Lines that divide each semidiurnal Arc into six equal Parts.* By W. A. Cadell, Esq. F.R.S. Lond. and Edin.

On the ancient sun-dials the day, from sun-rise to sun-set, was divided into 12 hours, which of course varied in length according to the season of the year. The object of this paper is to explain the nature of the lines by which this division was accomplished.

An account of this paper has been given already in the *Annals*, vol. viii. p. 63, and it would be difficult to add to that account without having recourse to figures.

5. *On the Origin of Cremation, or the Burning of the Dead.* By John Jamieson, D.D. F.R.S. and F.A.S. E.

The earliest mode of disposing of the dead seems to have been inhumation. Burning them was a subsequent practice. The object of this curious paper is to endeavour to account for the origin of cremation. Much learning and acuteness is displayed; but the ingenious author, as is too often the case in antiquarian researches, has left matters pretty much as he found them.

6. *Additional Communications respecting the blind and deaf Boy, James Mitchell.* By John Gordon, M.D. F.R.S. Edin.

This paper contains an account of an attempt to teach the boy by means of tangible letters, suggested by Mr. Parker; but it completely failed, from want of application on the part of Mitchell himself.

7. *On the Education of James Mitchell, the young Man born blind and deaf.* By Henry Dewar, M.D. F.R.S. Edin.

The author of this paper proposes to have words cut in relief in the written character, and to make Mitchell comprehend them by associating them with the things of which they are the names. After he has acquired a good stock of words, he may proceed to the letters,

if it be found that he has an inclination for the task. It is to be hoped that the ingenious plan sketched out in this paper will be attempted to be put in practice. There can be no doubt that much valuable knowledge may be conveyed in this way, provided the first reluctance of Mitchell can be overcome.

8. *On the Optical Properties of Muriate of Soda, Fluuate of Lime, and the Diamond, as exhibited in their Action on polarized Light.* By Dr. Brewster.

Crystallized bodies are of two kinds—those that refract doubly, and those that want that property. Those bodies which crystallize in cubes or octahedrons do not refract doubly. Laplace and Biot have shown that doubly refracting crystals are divisible into two classes: those, such as calcareous spar, in which the extraordinary ray is repelled from the axis; and those, as quartz, in which the extraordinary ray is attracted towards the axis. Hence it has been concluded that common salt, fluor spar, diamond, spinell, and other bodies which do not refract doubly, neither attract nor repel the extraordinary ray. Dr. Brewster, on examining large crystals of these bodies, found that they acted on light; in some parts as the first class of doubly refracting crystals, in others as the second class, and that in some parts there was no action. He considers these effects as occasioned by slight deviations from the cubic or tetrahedral structure. When they deviate a little on one way, they affect light as the first class of doubly refracting crystals; when they deviate a little the other way, they act as the second class.

9. *On a new Optical and Mineralogical Property of Calcareous Spar.* By Dr. Brewster.

Many specimens of calcareous spar form a multiplicity of images affected with the most brilliant colours. Dr. Brewster shows in this paper that these specimens contain within them a vein of calcareous spar, the axes of which are inclined at an angle of 45° to those of the external crystal.

10. *On the Ancient Geography of Central and Eastern Asia, with Illustrations derived from recent Discoveries in the North of India.* By Hugh Murray, Esq. F.R.S. Edin.

The object of this valuable paper is to show that the *Serica* of the ancients was China; and that Ptolemy's description of Asia is in its great outlines more correct than that of modern geographers.

11. *An Analysis of Sea Water, with Observations on the Analysis of Salt Brines.* By John Murray, M.D. F.R.S. Edin.

There is a great want of uniformity in the analyses of sea water hitherto published. Lavoisier obtained from a French pound—

Common salt	126 gr.
Muriate of magnesia	144
Muriate of lime	23
Sulphate of soda and sulphate of magnesia	7
Sulphate and carbonate of lime	8

Bergman got from an English pint of sea water—

Common salt	241 gr.
Muriate of magnesia	65·5
Sulphate of lime	8

Vogel and Lagrange obtained from 1000 parts of sea water—

Common salt	25·1
Muriate of magnesia	3·5
Sulphate of magnesia	5·78
Carbonates of lime and magnesia	0·20
Sulphate of lime	0·15

Lavoisier evaporated the sea water to dryness. The dry mass was digested in alcohol. The undissolved residue was digested in a mixture of two parts alcohol and one part water. In all the other analyses the portion insoluble in alcohol was digested in pure water. Dr. Murray conceiving that the peculiar results obtained by Lavoisier were owing to his peculiar mode of analysis, thought it proper to repeat the analysis according to the mode practised by that chemist.

Four pints of water from the Frith of Forth were evaporated till a pellicle formed on the surface. The precipitate that fell was a mixture of sulphate of lime and of carbonates of lime and magnesia. The liquid was now evaporated to dryness, and the saline mass thoroughly dried at the temperature of 150°. It weighed 1025 grains. It was digested in four ounces of alcohol of the specific gravity 0·840. The portion dissolved consisted chiefly of earthy muriates. The undissolved portion was digested in a weak spirit, composed of two parts of alcohol and one part water. The greater part was dissolved. The undissolved portion was again digested in still weaker spirit. Lastly it was digested in warm water. A light, soft, tasteless powder, now remained. These different liquids being examined, the saline ingredients found were the following (supposing only a pint of water to have been employed):—

Common salt	182·1
Muriate of magnesia	25·9
Sulphate of soda	7·5
Sulphate of magnesia	5·9
Sulphate of lime	7·1

228·5

He now performed the analysis of sea water in the common mode, as practised by Vogel and Lagrange. From a pint of water he obtained the following saline ingredients:—

Common salt	184
Muriate of magnesia	21·5
Sulphate of soda	2
Sulphate of magnesia	12·8
Sulphate of lime	7·3

227·6

From these results it is obvious that the saline substances obtained depend in some measure upon the mode of analysis employed. Dr. Murray has offered a very ingenious explanation of this apparent inconsistency. It has been shown by Berthollet that cohesion has such an influence on the action of salts on each other, that when different salts are mixed in solution, and the liquid evaporated, we can always predict what the salts are which will be obtained. The salts formed will always be those which are on the whole least soluble in water. Dr. Murray conceives that when the liquid in which salts exist is in a very diluted state, the contrary influence exerts itself, in consequence of which those salts exist in the liquid which are upon the whole most soluble.

From this principle, which is very plausible, it follows that in sea water the constituents must be common salt, muriate of lime, muriate of magnesia, and sulphate of soda. When the liquid is evaporated to a certain extent, sulphate of lime and sulphate of magnesia are formed by the decomposition of the sulphate of soda, which is converted into common salt.

By examining sea water by means of precipitants, Dr. Murray shows that the saline elements in a pint of sea water are as follows :

Lime	2.9 gr.
Magnesia	14.8
Soda	96.3
Sulphuric acid	14.4
Muriatic acid	87.7
	<hr/>
	226.1

If we adopt the explanation of the action of salts on each other according to the state of the liquid in which they exist, the true saline constituents of a pint of sea water must be as follows :—

Common salt	159.3
Muriate of magnesia	35.5
Muriate of lime	5.7
Sulphate of soda	25.6
	<hr/>
	226.1

12. *Elementary Demonstration of the Composition of Pressures.* By Thomas Jackson, LL.D. F.R.S. Edin. and Professor of Natural Philosophy in the University of St. Andrew's.

It would be impossible, without figures, to render this ingenious paper intelligible to our readers.

13. *Account of the remarkable Case of Margaret Lyall, who continued in a State of Sleep nearly six Weeks.* By the Rev. James Brewster, Minister of Craig.

This is a very curious account. Margaret Lyall had repeated occurrences of her lethargy. The first time it came on with a bleeding in the nose, and her sleep lasted three days. The next sleep lasted

six weeks; though she swallowed food, and had occasional alvine evacuations during the time. She had two subsequent lethargic fits, neither of which lasted above a few days. Her end was melancholy. She hanged herself at Dunninald, where she acted as a servant to the family.

14. *A general Formula for the Analysis of Mineral Waters.* By Dr. Murray.

This paper being of considerable practical importance, we shall publish it in a future number of the *Annals of Philosophy*.

ARTICLE XIII.

Proceedings of Philosophical Societies.

ROYAL SOCIETY.

ON Thursday, May 22, the remainder of Dr. Davy's paper on the Temperature of the Air and the Ocean, and the Specific Gravity of the Sea in Tropical Climates, was read. The temperature of the ocean differs as much at different times of the day as the temperature of the air. In general it is hottest about three o'clock in the afternoon, and coldest at sun-rise. Its temperature is much affected by shallows and by currents. It is now well known that the sea over shallows is colder than when deep. This Dr. Davy verified both at the Cape of Good Hope and at Ceylon. They were two days in approaching the Cape at the rate of two miles an hour. The temperature sunk from 60° to 58° before they were in sight of land, and indicated their approach to it. The same diminution of temperature took place as they approached Ceylon. Currents affect the temperature of the sea very much. Those that flow from a cold quarter are colder than the temperature of the sea through which they flow; while those from a warm quarter are hotter. One of the greatest is that which flows on the south-east side of Africa, and which has been accurately described by Major Rennel. It is about 130 miles in breadth, and runs most rapidly at the western edge, where its temperature is 10° higher than that of the surrounding sea. This current is employed by Dr. Davy to explain a phenomenon not yet accounted for, namely, the clouds which settle on the summit of the Table Mountain when a south-east wind blows. These clouds are known by the name of the Table-cloth. They are occasioned by this cold wind condensing the warm vapour as it passes over this current. Dr. Davy, during his residence at the Cape, had an opportunity of seeing the passage of the clouds along the sea to the mountain. It was very rapid.

At the same meeting a paper by Mr. Sewell, Assistant at the Veterinary College, was read, describing a new mode of curing a

chronic lameness in the feet of a horse. The most valuable horses in this country are apt to be lamed in the fore feet, usually in consequence of forced exercise. They are often sold in this state for very inferior employments, or even altogether destroyed. A charger having got a chronic lameness in the fore foot, and having been treated in vain by different practitioners, was given by the owner to the Veterinary College for experiment. It occurred to Mr. Sewell that, by cutting the nerves that enter the foot, the sensibility might be destroyed, and the lameness removed. He accordingly cut out about two inches of the nerves that entered the pastern, sewed up the place, and healed it. The consequence was the removal of the lameness, and the restoration of the horse to the owner perfectly sound.

On Thursday, June 5, a paper by Dr. Leach was read, on the genus *ocythœ* of Rafanesque. The animal of which Rafanesque has made a new genus under the above name is often found in the shell of the paper nautilus; and on that account many naturalists have considered it as the original inhabitant of that shell. Others are of a different opinion. Dr. Leach considers the observations made by the gentlemen of the late Congo expedition as deciding the question. Various paper nautili were caught containing these animals in them. When put into water, the animal moved about like a common polypus, left the shell, attached itself to the sides of the vessel, and showed no inclination to return to it again. These and similar observations induce Dr. Leach to conclude that the true inhabitant of the paper nautilus shell is still unknown, and that the animal in question does not belong to it, though it occasionally takes up its residence in it.

At the same meeting, a paper by Sir E. Home, Bart. was read, explaining the differences between the *sepia* and shell vermes. When the young is in the egg, the blood is aerated through its coats. On that account the shell of shell vermes is not formed till after they are hatched. To secure the egg from injury, it is put into an annular bag. The author gives a description of the *auriculata*, and shows that the animal found in it is a *sepia*, and not the original animal of the shell, from the way in which the young are produced.

On Thursday, June 12, part of a paper by Sir Wm. Herschell, LL.D. &c. was read, on the way in which the stars are distributed in space. Astronomers have divided stars into seven classes, according to their brightness. This difference of brightness must be owing to the difference of distance. The author proposes a new distribution into four sets.

On Thursday, June 19, Sir William Herschell's paper was concluded. He conceived it probable that the light emitted by each star is inversely as the square of its distance. He therefore contrived a method of comparing the light given out by the different stars, which he described in the paper. From this method it follows that the distance of the smallest star visible to the naked eye is 12

times as great as that of a star of the first magnitude. He gave an account of the shape and distribution of the milky way. He found that many of the stars of which it is composed are 900 times further off than stars of the first magnitude. He concluded from his observations that the sun and all the visible stars constitute a portion of the milky way.

LINNEAN SOCIETY.

On Saturday, May 24, the Society met for the election of office-bearers for the ensuing year. The following members were chosen:

President.—Sir James Edward Smith.

Treasurer.—Edward Forster, Esq.

Secretary.—Alexander Macleay, Esq.

Under Secretary.—Mr. Richard Taylor.

There remained of the old council:—Sir James Edward Smith; Samuel, Lord Bishop of Carlisle; Edward Foster, Esq.; George Bellas Greenough, Esq.; Aylmer Bourke Lambert, Esq.; William Horton Lloyd, Esq.; Alexander Macleay, Esq.; William George Maton, M.D.; Joseph Sabine, Esq.; Lord Stanley.

There were elected into the council:—Michael Bland, Esq.; George, Earl of Mountnorris; Sir Christopher Pegge; William Pilkington, Esq.; Charles Stokes, Esq.

On Tuesday, June 3, a paper by Mr. Salisbury was read, containing a description of the seeds of the *lycopodium denticulatum*. He found the description of Brotero in most particulars correct. He exhibited drawings of the seeds from the earliest periods in which they have been perceived to their ripe state.

At the same meeting a description of a new species of malaxis by Dr. W. Barton was read. Dr. Barton found the species near Philadelphia, and called it *longifolia*, because its leaves are twice the length of those of the two species previously known.

At the same meeting a description of the *lycoperdon solidum*, by Dr. Macbride, of Charleston, Carolina was read. The substance so called is an immense tuber, sometimes 40 lb. in weight, found in the southern parts of the United States. It may be used as food. Soon after it is dug up it becomes very hard. It exhibits no regular structure, and seems to have the property of uniting with the roots of those trees near which it grows. It vegetates under the earth, and is usually found in fields that have been cleared of wood only about three years.

On Tuesday, June 17, a paper by Sir James Edward Smith was read, giving a description of a rhizomorpha found in a well at Derby.

At the same meeting, a paper by Mr. Seaton was read, on the red and white varieties of the *lychnis dioica*. Some botanists are of opinion that these two plants constitute two distinct species, while others think that they are only varieties. To decide the point, Mr. Seaton placed them near each other. The produce was a hybrid plant with pink flowers, which was capable of producing seeds like

any other plant. Hence he conceives it to follow that they are only varieties.

At the same meeting, Dr. Leach announced that he had examined the specimen sent from Hull under the name of the many-headed serpent, and found it to be the penis of a sow.

ROYAL SOCIETY OF EDINBURGH.

On the 19th of May a paper by Mr. Stevenson, civil engineer, was read, regarding the operation of the waters of the Ocean and of the River Dee, in the basin or harbour of Aberdeen; from which it appears that Mr. Stevenson, in the month of April, 1812, with the use of an instrument (of which he exhibited a drawing), has been able to lift salt water from the bottom, while it was quite fresh at the surface, and has satisfactorily ascertained that the tidal or salt waters keep in a distinct stratum or layer under the fresh water of the River Dee. This anomaly, with regard to the salt and fresh waters, appears in a very striking manner at Aberdeen, where the fall of the Dee is such as to cause river water to run down with a velocity which seems to increase as the tide rises in the harbour and smooths the bed of the river. These observations show that the salt water insinuates itself under the fresh water, and that the river is lifted *bodily upwards*; thus producing the regular effect of flood and ebb tide in the basin, while the river flows downward all the while with a current which for a time seems to increase as the tide rises.

These facts, with regard to the continual course of the River Dee downward, is such a contrast to the operation of the waters of the Thames, as seen by a spectator from London Bridge, that Mr. Stevenson was induced to extend his experiments to that river in the years 1815 and 1816, by a train of experiments and observations from about opposite to Billingsgate all the way to Gravesend.

The waters of the Thames opposite the London Docks' gates were found to be perfectly fresh throughout; at Blackwall, even in spring tides, the water was found to be only slightly saline; at Woolwich the proportion of salt water increases, and so on to Gravesend. But the strata of salt and fresh water is less distinctly marked in the Thames than in any of those rivers on which he has hitherto had an opportunity of making his observations. But these inquiries are meant to be extended to most of the principal rivers in the kingdom, when an account of the whole will be given.

From the series of observations made at and below London Bridge, compared with the river as far up as Kew and Oxford, Mr. Stevenson is of opinion that the waters of the Thames seldom change, but are probably carried up and down with the turn of the alternate tides for an indefinite period, which he is of opinion may be one, if not the principal, cause of what is termed the extreme softness of the waters of the Thames.

Mr. Stevenson has made similar experiments on the Rivers Forth and Tay, and at Loch Eil, where the Caledonian Canal joins the

Western Sea. The aperture at Curran Ferry for the tidal waters of that loch being small compared to the surface of Loch Eil, which forms the drainage of a great extent of country. It therefore occurred to Mr. Stevenson that the waters of the surface must have less of the saline particles than the waters of the bottom. He accordingly lifted water from the surface at the anchorage off Fort William, and found it to be 1008·2; at the depth of nine fathoms, 1025·5; at the depth of 30 fathoms, in the central parts of the loch, it was 1027·2; indicating the greater specific gravity, and consequently more of the saline parts as the depth of the water is increased.

GEOLOGICAL SOCIETY.

April 6.—A letter from Dr. Meade to Mr. Vaughan was read, relating to the slab of serpentine from North America.

The quarry whence the slab was obtained is situated near the town of Milford, in Connecticut. It is a serpentine rock. The whole country in the neighbourhood is of primitive formation, consisting principally of gneiss and granite alternating with primitive lime-stone. A stratum of the serpentine several yards wide runs between the lime-stone. It extends for several miles, accompanied with asbestos, amianthus, and diallage. The quarry is extensively worked.

This serpentine has considerable resemblance to verd antique; the green parts, which are the most abundant, are of serpentine. Veins of white calcareous spar run through it, and also black pieces of chromate of iron. From this latter circumstance, Dr. Meade is induced to think that all the noble or green serpentines are coloured by the green oxide of chrome.

A paper by the Rev. W. Buckland, M.G.S. Prof. Min. Oxford, entitled, Additional Observations on the Beds of the Plastic Clay Formation, was read.

Since the author's former communication to the Society he has traced beds similar to those observed near Reading and Woolwich, in various other parts of the London basin, as well as in several parts of the Isle of Wight basin.

These observations establish the identity of the deposits, and show a formation next in order of succession above the chalk. This formation is analogous to the series of beds which in France have received the name of plastic clay, and it consists of an indefinite number of beds of sand, clay, and pebbles, irregularly alternating. Of these, in England, the sand forms the most extensive deposition, in which the clays and pebbles are interposed subordinately, and at irregular intervals. The occurrence of organic remains in this formation is, like the alternation of the strata composing it, exceedingly irregular; sometimes they occupy the clay, at other times the sand or pebbles, and very frequently are wanting in them all. These organic remains consist principally of shells of the genera *ostrea*, *cerithium*, and *cytherea*. Sections of these beds as

seen at Lewisham, New Cross, and Newhaven, are given in detail, and agree with those of Reading and Woolwich, as well as with a section of Dieppe communicated to the author by Mr. Brongniart. In several places near the metropolis the London clay is seen in detached portions resting on these beds. The author supposes that these portions of the London clay are the remaining parts of a continuous stratum that once covered the whole of the intervening country, and connected the deposits of Sydenham, Shooter's Hill, and Highgate.

May 2.—A paper by S. Giovanni Massa, Elève of the Council of Mines of Milan, entitled, Observations on the Mineralogy of the Ligurian Mountains and the hills of Montferrat, was read.

The mountains which form this range are a branch of the Alps that separate the plains of Piedmont from the sea. That part which extends along the northern side of the states of Genoa is called the Ligurian Apennines. The rock most abundant here is green serpentine, of various shades of colour, frequently interspersed with greenish-brown diallage. The serpentine passes into chlorite-slate, which, on the other hand, at a place north of the Giovi, passes into gneiss.

Beds of lime-stone, both primitive and secondary; of greenstone containing epidote, and of a conglomerate of which the fragments are chiefly of serpentine, are enumerated among the rocks of this district. The author also mentions the occurrence of several minerals, among which is idocrase, much resembling that of Piedmont.

On the northern side of these mountains, towards Montferrat, are high hills formed of an alluvium resulting from the fragments of all the rocks of this district, the parts diminishing in size as the distance from the mountain increases. Beyond these hills are those of Montferrat, of a less elevation, composed of alternating beds of sandstone and tufa, and containing numerous organic remains, such as encrinites, ostracites, nummulites, &c.

The nature of the substances that compose this large deposit, as well that of the alluvial hills as of the hills of Montferrat, combined with the circumstance of the size of the parts of which it is formed, diminishing as the distance from the mountains increases, are, in the author's opinion, proofs that it has been formed by the action of some violent current coming from the Mediterranean, which has worn the mountains in its passage. Thus the fragments of the serpentine rocks, being the largest in size, have been the first deposited; and the calcareous cement is in such small quantity, that it hardly holds them together. The hills of Montferrat are formed of much finer particles; and their composition, containing all the materials that compose the gneiss, the author attributes their origin to that rock, which occurs in sufficient abundance in the western mountains of Liguria to justify this supposition.

ROYAL GEOLOGICAL SOCIETY OF CORNWALL.

At the quarterly meeting of this Society a paper was read, on the

different Tests for the Discovery of the Presence of Arsenic, by Dr. Paris. The author stated that, since the extraordinary and notorious trial at the late Assizes, his opinion had been so repeatedly solicited upon the subject of *arsenical tests*, that he felt it his duty to offer the present paper as an answer to them. It afforded him also an opportunity of communicating to the Society a simple method of so modifying the ordinary experiments as entirely to avoid those fallacies which had been attributed to them. The test of *nitrate of silver* was well known to furnish its indication by the colour of the precipitate which it induced with the suspected liquid. It had, however, been observed by a pupil of Dr. Marcet that the *phosphoric salts* had the property of throwing down with *nitrate of silver* a precipitate perfectly analogous in colour to that from arsenic; and as these salts were known to have existence in the animal fluids, a source of perplexity and error was thus connected with any experiment, with *nitrate of silver*, on the contents of the stomach. This difficulty, however, the author stated might be overcome by modifying the experiment as follows:—Instead of conducting the trial in glasses, drop the suspected liquor upon writing paper, making a broad line with it. Along this line a stick of *lunar caustic* is to be slowly drawn, when a streak is produced of a colour resembling that known by the name of the *Indian yellow*, and this is alike obtained by the presence of arsenic and of phosphoric salts; but the one from arsenic is rough and curdy, as if effected by a crayon; the other, quite smooth and even in its appearance, such as would be produced by a water colour. A more important, and still more unequivocal mark of distinction, soon succeeds: in less than two minutes the phosphoric yellow fades into a “*sad green*,” becoming gradually darker until it becomes black; the arsenical yellow, on the other hand, remains permanent for some time, when it becomes brown. In performing these experiments, the sun-shine should be avoided, or the transition of the colour is too rapid. This experiment, however, is not related with a view to supersede the more important one of the reduction of the metal: indeed, in a matter of such serious importance, observed the author, a combination of unequivocal proofs was required. Mr. Gregor had suggested to him the application of a *nitrate of titanium* as a new test. In this case the suspected powder should be treated with nitric acid. The circumstance, however, of the phosphoric acid precipitating the titanium in a manner similar to arsenic, offered an objection which he was not prepared to surmount. It was, however, well worthy the attention of chemists.

Sir Rose Price, Bart. V.P. communicated to the Society a Resolution of the Grand Jury at the late Lent Assizes for the county, framed in consequence of a recommendation from Mr. Justice Abbot, conveyed in his charge to them; the object of which was to impress upon the mining interests the great importance of immediately introducing the “*Safety Instruments*” for the prevention of the accidental explosion of gunpowder, described in a pamphlet lately published by John Ayrton Paris, M.D.

Mr. Gregor announced, through Dr. Paris, a new species of coal which accompanies the *calm*, imported from Wales for the purposes of *smelting*. This substance is characterized by a property of detonating most violently with *nitrate of barytes*; the result of which is the most copious evolution of *prussic acid*, and the formation of a prussiate, together with a carbonate of barytes.

A paper was also read, by John Henry Vivian, Esq. entitled, A Sketch of the Plan of the Mining Academies of Freyburg and Schemnitz. The object of this paper was to point out to the Society the useful and objectionable parts in the detail of these schools, in order to assist the Council in their intended arrangement of a mining academy in Cornwall, and of the establishment of a Professor's chair; and he informed the Society that when such an arrangement was completed he should present to it his mineralogical collection, formed at Freyburg, immediately under the eyes of Werner.

Dr. Paris reported that he had been desired to state to the Society, by a letter addressed to him in the county newspaper, the evils and accidents which arose from the use of what is termed the *standard barrow*, for carrying copper ore, the weight of which can be little less than four hundred weight. This enormous burthen is borne by all descriptions of persons who are employed in dressing and weighing. It has been asserted that this pernicious practice has given rise to diseases of the most fatal kind.

It was resolved that this notice should be entered upon the minutes.

ARTICLE XIV.

SCIENTIFIC INTELLIGENCE; AND NOTICES OF SUBJECTS CONNECTED WITH SCIENCE.

I. Lectures.

Mr. Gray, of No. 27, Cross-street, Hatton Garden, began his summer course of botanical excursions into the environs of London, with practical demonstrations of the plants collected in them, on Tuesday, June 3, and continues them twice a week: Mr. Gray has been induced to adopt this plan of teaching in preference to the more formal method of lectures, as better adapted to the improvement of the pupils.

II. Further Improvements in Professor Leslie's Method of producing Ice.

(To Dr. Thomson.)

DEAR SIR,

Edinburgh, May 20, 1817.

I think it worth while to mention, in this stage of my experiments, that *parched oatmeal* has a stronger and more extensive

power of absorbing humidity than even the decayed trap rock. With about three quarters of a pound of meal, occupying a surface of seven inches in diameter, I froze nearly a quarter of a pound of water, and kept it for the space of 20 hours in the form of ice till one half of the congealed mass was again melted. The temperature of the room being nearly 50° , the meal had then absorbed the 18th part of its weight, though it had not yet lost more than one-third of its desiccating power. With a body of dried oatmeal a foot in diameter, and rather more than one inch deep, I have since frozen a pound and a quarter of water contained in a hemispherical porous cup, and, though the room is warmer than before, the energy of absorption seems to be capable of maintaining the state of congelation for a considerable time. It is curious to observe that when the experiment was reversed, and the surface of the water about double that of the meal, this substance acquired, after the air under the receiver had been rarified, a heat exceeding 50° of Fahrenheit, so as to feel, indeed, sensibly hot on applying the hand.

I am, dear Sir, sincerely yours,

JOHN LESLIE.

III. *Philosophical Society of London.*

The Anniversary Meeting of the Philosophical Society of London was held at the Society's rooms, adjoining Scots' Corporation Hall, Crane-court, Fleet-street, on Thursday, June 12. The following Noblemen and Gentlemen were chosen officers and Council for the ensuing year :—

President.—Right Hon. the Earl of Carysfort, K.P. F.R.S. F.A.S. D.C.L.

Vice-Presidents.—Right Hon. Lord Henniker, F.R.S. F.A.S.; Sir J. C. Hippisley, Bart. M.P. LL.D. F.R.S. F.A.S.; Isaac Hawkins Browne, F.R.S.; Rev. W. B. Collyer, D.D. F.A.S.; Olinthus Gregory, LL.D.; Rev. A. Rees, D.D. F.R.S. F.L.S.; James Sowerby, F.L.S. G.S.W.S.; J. F. Vandercom, F.G.S.

Treasurer and Honorary Secretary.—Thomas Joseph Pettigrew, F.L.S.

Registrar.—John Miers.

Assistant Ditto.—T. K. Cromwell.

Curators.—W. C. Pettigrew; T. J. Armiger.

Orator for 1818.—John Mason Good, F.R.S.

Council.—Thomas Adams; James Andrewes; Jonathan Barber; Rev. George Bathie, D.D.; Thomas Bedder; Benjamin Bensley; Clarke Burton; Jonathan Thomas Cooper; George Dudley; Thomas Fisher; Charles F. Forbes, M.D.; H. C. Hodge; Samuel Meadows; B. H. Smart; Peter Thomas; Richard Thompson; Thomas Tucker; Rev. T. M. Young, LL.B.

The Anniversary Oration was delivered by Dr. Gregory, and will shortly be published. It was very numerously attended; as was also the dinner; and many excellent addresses were made by H. R. H. the Duke of Sussex, who was in the chair, by Lords

Erskine, Kenniker, &c.; Drs. Gregory, Mason, Collyer; Messrs. Coleridge, Pettigrew, &c. &c. &c.

A volume of Transactions of the Society is now in the Press, and will appear about the close of the present year.

IV. Prize Question by the Royal Medical Society of Edinburgh.

The Royal Medical Society of Edinburgh propose, as the subject of a prize essay for the year 1818, the following question:—

“What changes are produced on atmospherical air by the action of the skin of the living human body.”

The members only are invited as candidates. The dissertations are to be written in English, French, or Latin, and to be delivered to the Secretary on or before Dec. 1.

To each dissertation shall be prefixed a motto; and this motto is to be written on the outside of a sealed packet containing the name and address of the author.

V. Query respecting the Diseases of the West Indies.

(To Dr. Thomson.)

SIR,

I shall feel extremely obliged if you will inform me, through the medium of your *Annals*, whether there are any treatises extant on the diseases of the West Indies; and, if there be any such, which would be the most useful to a person about to embark.

With great respect I remain, your obliged humble servant,

May 20, 1817.

Z.

The works of Dr. Grainger and Dr. Moseley on the diseases of the West Indies are well known. In the year 1801 Mr. Clark published observations on the nature and cure of fevers and of diseases of the West and East Indies and of America, with an account of dissections performed in these climates, and general remarks on the diseases of the army. From any of these works my Correspondent will obtain, in all probability, the information which he wants.—T.

VI. On Sailing to the North Pole.

(To Dr. Thomson.)

SIR,

Glasgow, May 17, 1817.

It was with the most lively pleasure I perused the questions and answers sent from Col. Beaufoy, in the last number of the *Annals*, respecting the practicability of reaching the North Pole. In since discussing the subject at a Society here, one of the members suggested that in very high latitudes the centrifugal power likely operates, which may account for all the masses of ice there making their way southward. This idea was combated by all present, excepting that gentleman and myself; they alledging that the effects of that power could not be seen there more than at the equator, and

that the cause of the southerly motion of the ice is the great tide making its way round the north capes of the Asiatic Continent, and from thence passing in a southerly direction.

I would fain cherish the hope that the above enterprise, if attempted, will be crowned with success, and that a northern terra incognita will yet be discovered, with perhaps human inhabitants, and probably the mammoth will be there seen alive. It is not many years since the remains of what was supposed one were found in these regions, with part of its flesh and skin fresh on the bones. This could not have been hundreds or thousands of years preserved there, amongst the snow, as was then asserted by naturalists, but must have come from some, perhaps that, terra incognita.

In one of the above answers quoted by Colonel Beaufoy it is said that certain people who have been on the high lands of Nordaster Island saw to the northward the whole sea clear of ice, and that large flocks of aquatic birds in the spring take a route in that direction even past Nordaster. I would ask, if there be no land, or if the sea there were "as a molten looking-glass," would their instincts lead them to perish in a quarter where nothing liquid was to be found?

I should be very glad of the opinion of yourself, or any of your intelligent readers, as to the centrifugal principle acting in the manner above mentioned. We all know that if it were not gravity counteracting, every substance, especially at the equator, would fly off in a tangent: but in the above case I see no law of nature to prevent the ice from obeying the centrifugal impulse; gravity cannot, as a floating body gets neither heavier nor lighter (properly speaking) by approaching to, or receding from, the pole. If it got heavier, all bodies would tend to the pole; and if lighter, then all would recede from it, and approach the equator.

But, on the other hand, it may be alleged that, suppose a vessel fitted out for the expedition could be got into the clear sea beyond Nordaster, it would be subjected to the same centrifugal impulse as the ice. This I grant; but then it would acquire by sails or steam, or both, an impelling power superior to the centrifugal; and the nearer the vessel approached the pole, unless the poles be very oblate, like those of an orange, the latter power would become weaker, as the velocity of the globe there would decrease.

I do not recollect in what direction navigators say the southern ice moves; but no approaches to the south pole have ever been made so near as to the other. Upon the whole, this is a subject that still wants much investigation; and as new ideas may be elicited by discussion, I hope you will invite your correspondents to turn their attention to it. Much light on natural history may be the result of a successful attempt to explore the "eternal pivots on which this world revolves."

I am your obedient,

B. Z.

VII. *Description of a Machine for raising heavy Weights, called a Jack.* By Mr. Moyle.

(To Dr. Thomson.)

SIR,

Being obliged some few months since to raise the roof of an old house that had sunk and fallen much into decay, I was under the necessity of having recourse to an instrument generally denominated the Jack, a machine worked by a handle communicating to a single tooth and pinion (sometimes they are multiplied) that raise a perpendicular lever, the power of which certainly is very great, but often not adequate to have the desired effect; and where they can be used, the immense weight causes so great a friction on the teeth of the lever, and owing to the lever being raised perpendicularly, its teeth become in a short time so much worn that before the second tooth of the pinion can act on the second tooth of the lever, the first is disengaged, and consequently the lever falls back; and no ground is gained. This was the case with one I was obliged at first to use, which of course not answering the purpose led me to think how to improve its construction. I have, therefore, had one made upon the following principle, which is equal to any weight; and, although the friction is very great, it is more generally diffused, so that the wear of any particular part is not so much but that it will continue useful for a great space of time beyond the one in common use, and by no means liable to the same defect.

It may be made more or less powerful, according to the nature of the screws. In the one I have the handles are turned 23 times while the head makes one revolution.

DESCRIPTION OF THE PLATE.

Let A (Pl. LXX. Fig. 4) be a firm cylinder of wood fixed to the bottom, B, and headed with a collar of steel, C, the upper surface of which is well polished, and on which revolves the head, D, wholly made of brass, the flanches of which, E, E, (Fig. 5) bear the friction, which, being made of these two metals, the wear is not so great. This head is revolved by a male iron screw axle, F F, working in a hollow female screw, G G, of the brass head, D. The small stop-wheel, L L, works against the brass collar, C. M, M, are the catches.

The cylinder is made hollow to allow the perpendicular lever, I, to rise and fall through the brass head, D, which has also a female screw, K, through which the male screw lever works. N, a knob or projection at the foot of the lever, to prevent its turning round, which of course it would in preference to the head, if not prevented. O is a forked head-piece, which may be taken off: its use is to fix firmly on any thing oblique which is to be raised.

I am, Sir, your most obedient,

M. P. MOYLE.

Helston, May 1, 1817.

VOL. X. N^o I.

E

VIII. *Query respecting the Mode of Freeing Wine from Common Salt.*

(To Dr. Thomson.)

SIR,

I should feel extremely obliged if you, or any of your correspondents, would inform me if there is any method of ridding some of the salt which may be mixed with it from the sea water, and that without injuring the wine, more particularly Port Wine; at the same time communicating the process, if any.

I am, Sir, yours, &c.

M. P. M.

I am not aware of any practicable method of freeing wine from common salt. Freezing would succeed if it could be employed without injuring the wine.—T.

IX. *Proposed Improvement in Brooke's Blow-pipe.* By Mr. Barchard.

(To Dr. Thomson.)

MY DEAR SIR,

As inventions in general admit of improvement, and gain it frequently from the ideas suggested by different individuals, it will not, I hope, be considered presumptuous in offering some further alteration at least, and I hope improvement, in Newman's blow-pipe, an instrument now so necessary to every chemical laboratory, from its portability, easy application, and extensive use, that every person having once had occasion to use it must be happy in being able to communicate any alteration that may lead to its further application, particularly as it has in its present state so far exceeded the ideas of its original maker, which was that of a common air blow-pipe only.

Its present application is, I believe, pretty generally known, viz. its condensed gaseous explodible mixture, which, notwithstanding the various improvements by Professor Cummings, Clarke, Wollaston, &c. is still too liable to explode to risk the use of a much larger reservoir than the one at present in use; though indeed, could we adopt ever so large a one, the same objection would still continue, namely, that of its decreasing in power as the pressure is taken off by the escape of a portion of the air; an objection of material consequence in the reduction of some of the refractory earths, when we frequently find the reservoir empty at the moment the most intense heat is required. It will perhaps be said that my proposed alteration will render it complicated, and of course more expensive; but surely we are not to give up the use of it in its more extended views because the cost is a few more shillings, particularly so when it is the only way in which we can at present attain the intense heat it produces.

The annexed sketch (Plate LXX. Fig. 2) will represent the means proposed for introducing a constant supply of gas by means of a double barrel condensing syringe, worked by a rack and sector; in which let A B represent two small condensing syringes, joined together at bottom with two plungers working in them, moved by the handle, D, and sector, C. There is also another tube, G, for the supply of gas from the bag, F, to the barrels. It will appear evident that by moving the handle the plungers will be ultimately raised and depressed, thus forcing a constant stream through the alternate valves, A A and B, to the reservoir, E. It will be advisable to place a small safety valve in the top of the reservoir, as represented at H, for the purpose of allowing a portion of the gas to escape, should it be supplied too fast by the syringes. The jet will be thus regularly maintained, and for any length of time. It might be conveniently attached to the treadle of a turning lathe, and thus filled by the foot, by substituting a crank for the sector.

I remain, Sir, respectfully yours,

R. W. BARCHARD.

X. *Another Improvement.* By Mr. Booth.

(To Dr. Thomson.)

DEAR SIR,

Barnet, April 15, 1817.

Having noticed several improvements proposed, in order to render the use of the gaseous blow-pipe more safe, I have been induced to make a further alteration in the construction of that useful instrument, which, by possessing several advantages of make, as well as extreme cheapness and simplicity, you may consider worthy a place in your *Annals*.

The apparatus consists of a large bladder to contain the mixed gases, mounted with a stop-cock, by means of which it may be filled from a transferring receiver without the least trouble. It is then placed between two boards, the uppermost of which moves in a frame, and contains the weights requisite for condensing the gases. The stop-cock screws into the top of one of Professor Cumming's safety cylinders, to which is added a jet of capillary tubes (as proposed by Dr. Clarke). [See Plate LXX. Fig. 3].

The advantages of this plan of construction are the following:—
 1. Extreme readiness of construction. 2. The advantage of increasing or diminishing the force of the jet by means of the weights. 3. Great safety: for, as the last portion of mixed gases is forced out with the same degree of force as the first (which is not the case in the condensing one), there is not that chance of an explosion from the retrograde motion of the flame (supposing it able to overcome the other precautions, which is not likely) as there is in others. And should such an accident happen, it would be attended with comparatively little danger. On this account the number of tubes in the fagot, and the diameter of the jet, may be increased with safety.

I am, Sir, yours truly,

THOMAS S. BOOTH.

P.S. Since writing the above (which I intended to have sent you last month), I have been informed that a similar mode of construction has been adopted by the Marquis Ripolti (if I am correct in the name). He uses two bladders; the one containing the hydrogen being furnished with a jet tube twice the size of that containing the oxygen, and the condensation formed by means of an iron bar, as the plan of using the gases separately does not appear to possess so good an effect as when combined in the same vessel. You may still consider my plan of sufficient safety and utility to lay before your readers.

XI. *Arithmetical Query.*

(To Dr. Thomson.)

SIR,

In the fourth number of the Literary Gazette, p. 57 (Feb. 13, 1817), the following intelligence is given:—

“M. Von Synghel, of Ghent, has employed nine years of intense study for the purpose of finding out some method of simplifying arithmetical calculations, and has succeeded, in the most complicated rules, in decomposing, producing, and reducing in one minute, and by means of a dozen figures, operations which required hours, and whole columns of almost unintelligible fractions. His method is applicable to money of all kinds.”

I dare say many of your readers, as well as myself, would be very glad to find this true. Will you, therefore, take the trouble to say if you know any thing respecting it; and if so, what means are to be taken to get possession of his method? Perhaps some of your correspondents may be acquainted with it, if you should not be.

Will you also be so kind as to inform me what method is generally thought best to adopt for a person to teach himself mathematics, what books are preferred, and what order the different branches should be studied in?

If you will indulge me with this information, I shall ever consider myself to be

Your very obliged servant,

May 21, 1817.

B. P.

I am sorry that it is not in my power to communicate any information respecting Von Synghel's alleged discovery, never having heard either of the discovery or its author till I received my correspondent's letter. The usual mode of studying mathematics in this country has been to read the first four books of Euclid; then to learn algebra, as far as the solution of quadratic equations; after this, the fifth, sixth, eleventh, and twelfth books of Euclid may be studied; trigonometry naturally follows; then conic sections; then fluxions. The best book on algebra that I have seen, as far as it goes, is Euler's, of which we have an English translation, I believe by Mr. Horner, of Bath; though I state this upon rather hearsay evidence. For the higher branches of mathematics, Euler's books

are still the best; nor is it likely that they will soon be excelled: they possess a clearness not to be found in any other writer on the higher branches of mathematics that I have ever looked into.—T.

XII. *Singular Formation found within an Egg.* By Mr. Strutt.

(To Dr. Thomson.)

SIR,

Having accidentally met with a curious formation in the inside of a common hen's egg, I have taken the liberty of sending an account of it for insertion in your *Annals* of next month.

This formation was discovered floating in the white part of a common egg. The outside consists of a shell exactly similar to that of the egg itself, but not so thick, and of a darker colour. It is about one inch and three quarters in length. Its greatest diameter, which is near the upper end, is about three quarters of an inch, and it tapers down to a point at the other end of an eighth of an inch in diameter. By piercing it at the top, and at the bottom, I was enabled, by applying my mouth to one end, to force out the contents, which I found exactly similar to the white of an egg, but there was no yolk. The shell gradually becomes thinner as it approaches the narrower end. In the centre of it, on the surface, there is an indentation, or ring, which extends a little more than half round the egg; and about a quarter of an inch from the narrower end there is another indentation, which extends almost the whole of the way round. The egg in which this singular curiosity was found was good in every other respect, and had in it a perfect yolk.

I am, Sir, your obedient servant,

Derby, May 21, 1817.

J. D. STRUTT.

XIII. *Effect of different Rocks in Scotland on the Magnetic Needle.*

By Mr. Webster.

(To Dr. Thomson.)

SIR,

Edinburgh, June 10, 1817.

The curious fact some years since noticed by my friend Professor Jameson, and lately by Dr. Macculloch, that the magnetic needle was sensibly affected when in contact with the granite of certain districts, led me to pay particular attention to the circumstance in a late tour through the highlands of Scotland. The instrument I used was the common miner's compass, and a comparison was often made with another of the same size and construction, placed in a distant situation.

Throughout the great formation of mica-slate between Tarbet and Tummel Bridge, the needle was often rendered stationary when the instrument was in contact with the strata. In other instances it varied from 3 to 8, and 15° from the point indicated by the other instrument, and it was more than once much agitated when brought near the subordinate beds of hornblende rock and felspar. In the

gneiss district of Garviemore I remarked but two instances, in which the motions of the needle were unusual; but at the well-known veins of granite at the Bridge of Grey it was rendered nearly useless, both when in contact with the veins, and when at some distance from them.

At the Fall of Fyers, when endeavouring to ascertain the position of the sienitic granite and the conglomerate, the motions of the needle were so irregular and varying, that little or no dependance could be placed upon it. This was the case both with regard to the granite and conglomerate. I was somewhat surprised to observe no effect whatever upon the motion of the needle when presented to the granite of Portsoy, but a very decided and powerful effect from the serpentine, whenever the instrument was brought within a few feet of it.

The granite of Aberdeen produced in some instances an effect, in others not the slightest, and this in different parts of the same vein. The only instance in which I have seen the action of the needle disturbed by the rocks of the trap formation was at Stonehaven, where an extensive bed and alternations of trap tuff with the other rocks occur. Here the needle was often, indeed almost constantly, affected. This may perhaps be in some degree attributed to the presence of red and brown hæmatite, which occur in innumerable small veins in the tuff. I have lately made some comparative experiments with the trap tuff of Salisbury Craig and Arthur's Seat, but have ever found the needle perfectly free in its motions. The green-stone of Salisbury Craig, however, frequently affects the needle, even in hand specimens; but in these the glass discovers numerous specks of the hydrate of iron, and often of the sulphuret, to the presence of which we must attribute this circumstance. In no instance have I found a piece of pure green-stone produce any effect.

I expected to have found some of the sand-stones, especially the old red sand-stone, affect the instrument; but in no instance were my expectations realised.

It may not be improper here to remark that I found sulphuret of iron in considerable quantity in the granite veins of Garviemore, and brown hæmatite in one instance at Aberdeen.

I am, Sir, yours, &c.

J. W. WEBSTER.

XIV. *Fusion of Wood Tin.*

Dr. Clarke, of Cambridge, has made a curious addition to our knowledge respecting wood tin. When exposed to the action of his powerful oxygen and hydrogen blow-pipe, it fuses completely, acquires a colour nearly similar to that of plumbago, with a very strong metallic lustre. Dr. Clarke was so obliging as to give me some specimens of wood tin thus fused. It was very hard; as far as I could judge, nearly as much so as common tin-stone. It was brittle, and easily reducible to a fine powder. I found it not in the

least acted on by nitric acid, muriatic acid, and nitro-muriatic acid, even when assisted by heat. Hence it must still continue in the state of an oxide.

The circumstance that wood tin (and probably tin-stone also) acquires a metallic lustre when fused, seems to decide a subject which has been agitated in this country with much keenness. It was asserted by Dr. Hutton, and is still maintained by his followers, that all granite has been in a state of igneous fusion. From Dr. Clarke's experiment, it may be inferred, with considerable confidence, that the granite in which the ores of tin occur has never been in a state of fusion.

XV. *Turkey Oil-stone.*

This stone, which comes from Iconium, in Asia Minor, and is used as a whet-stone, was lately analyzed by Mr. Holme, from a specimen given to Dr. Clarke by Mr. Knight, of Foster-lane. Its constituents were as follows :—

Silica (in very fine powder)	72
Lime	13 $\frac{1}{8}$
Carbonic acid	10 $\frac{1}{8}$
Alumina	3 $\frac{1}{8}$

100

XVI. *Black Powder remaining after the Solution of Tin in Muriatic Acid.*

Mr. Holme has lately analysed this black powder, which has been long known, and generally supposed to contain arsenic. He finds it a pure protoxide of copper. I think it but fair to mention that I had been informed by Dr. Wollaston, several months before I heard of Mr. Holme's experiments, that the black powder was copper. Dr. Wollaston had determined its nature by experiment.

XVII. *Holmite.*

Dr. Clarke has given this name to a singular lime-stone found in the pavement of Cambridge, and analysed by Mr. Holme. The following is his account of it :—

“ It was found in the pavement of our streets, and brought to me as a mass of emery. Its effervescence in warm acids betrayed its real nature; but its remarkable specific gravity, which equals 3.597, being equal to, if not greater than Jameson's compact brown iron-stone (vol. iii. p. 258), induced me to pay more attention to it. When acted upon by the blow-pipe, minute particles exhibiting a pseudo-metallic lustre are manifested, and these of course are mica; but they are not visible until the stone has been thus heated. When this mineral was first brought to me it had the form of an oblique, rhomboidal, four-sided prism. It was of very considerable magnitude. We know not whence it came; therefore,

if you see no objection, I shall call it *Holmite*. The following is Holme's analysis of this mineral :—

Lime	27 gr.
Carbonic acid	21
Alumina	6 $\frac{2}{8}$
Silica	6 $\frac{2}{8}$
Iron oxide	28 $\frac{1}{8}$
Water	10
	<hr/>
	100

XVIII. *Account of a very remarkable Mineral Water.* By Mr. Garden.

(To Dr. Thomson.)

SIR,

Some time ago I was requested to examine a sample of an acidulous water (which had lately been imported into this country) with a view to ascertain whether it could be applied to any useful purpose. The extraordinary physical properties which it seemed to possess excited in no small degree my attention; and I found, upon inquiry, that the gentleman from whom I received it, and who brought it to England, had discovered it upon an island in the South Sea. The island, he informed me, is laid down on some of our maps. It is called White Island, and is situated on the coast of New Zealand. It is believed to be of a very volcanic nature, as a considerable portion of its surface exhibited the phenomenon of combustion.

The water in question issues from a lake of considerable magnitude, and constitutes a small rivulet, which flows into the ocean. Its temperature, when taken up, was considerably above that of the atmosphere.

The physical characters of the water as I received it are as follows:—It is of a pale yellowish-green colour; it has an odour resembling that of a mixture of muriatic and sulphurous acids, and possesses a strong acid taste, in which the styptic taste of a weak solution of iron is discernible. Specific Gravity, 1·073.

With regard to the chemical constitution of this fluid I have not as yet had sufficient leisure to determine it with that precision which its peculiar nature appears to demand: as I propose to do this at a future opportunity, I shall content myself for the present with stating its composition, in so far as the experiments which I have hitherto made enable me to do.

A solution of carbonate of soda, when dropped into a portion of the water, produced a brisk effervescence; and when added to saturation, a light brown flocculent precipitate fell down.

Muriate of barytes occasioned a decided precipitate insoluble in nitric acid.

Nitrate of silver produced a dense white coagulum, which became coloured by exposure to the solar rays.

A thousand grains of the water was introduced into a glass retort, and distilled to dryness.

The distilled fluid (in which a few minute particles of sulphur were observed to float) was but slightly affected by the addition of nitrate of barytes; but when treated with nitrate of silver, an abundant and dense precipitation of muriate of silver instantly ensued. The precipitate, when washed and desiccated, weighed 250 gr., thereby indicating the presence of about 62½ gr. of muriatic acid.

The mass which remained in the retort was digested in distilled water; the whole was dissolved, to the exception of a small quantity of a very insoluble salt, which upon examination appeared to be sulphate of lime. The fluid, after being concentrated by evaporation, was set aside for some days, at the end of which a group of octohedral crystals of alum were observed to have been formed. The remaining liquid, when decanted from the crystals, and decomposed by a solution of carbonate of soda, gave a precipitate, which, when treated by caustic potash, yielded pure alumine and oxide of iron.

From the preceding cursory analysis, to which it will be observed I have submitted this curious mineral product, it would appear to consist chiefly of muriatic acid, a slight trace of sulphur, small proportions of alum, muriate of iron, (probably sulphate of iron), and sulphate of lime.

As I am not aware that any similar mineral water is known, or ever has been described, in which uncombined muriatic acid* forms the leading constituent part, it may in this respect justly be considered as a curious production of the mineral kingdom.

I am, Sir, your obedient servant,

372, Oxford-street, London.

A. GARDEN.

ARTICLE XV.

New Patents.

JOHN BARTON, of Silver-street, London, civil engineer; for certain improvements in pistols. Aug. 31, 1816.

JOHN KIRKMAN, of Broad-street, St. James's, Westminster; for a method of applying an octave stop to piano-fortes. Oct. 14, 1816.

* Vauquelin is said to have found it in a free state in a volcanic rock situated in the Puy-de-Dome; and there is, I believe, in the 18th volume of the *Annales du Musée*, an interesting paper by Leshenault on a sulphuric acid lake at the bottom of Mont Idienne, on the south-east coast of Java; but this, as the name announces, is almost wholly composed of sulphuric acid.

LOUIS FAUCHE BOREL, of Frith-street, Soho, Esq.; for a method of making boots and shoes without sewing, so as entirely to keep out the wet; which invention may be applied to other useful purposes in leather. Oct. 25, 1816.

LEWIS GRANHOLM, Foster-lane, London, a Captain in the Navy; for a method or methods, process or processes, or means, for rendering or making articles made or manufactured of hemp or flax, or of hemp and flax mixed, more durable than any such articles are as now made or manufactured. Oct. 25, 1816.

WILLIAM BARLEY, of Hunslet, parish of Leeds, wire-worker; and **ROBERT HOPWOOD FURNESS**, of Birdlington, Yorkshire, soap-boiler; for a method of obtaining or producing saccharine matter or substance from wheat, rye, oats, and barley, bear or big. Nov. 1, 1816.

JOSEPH GREGSON, of Charles-street, Grosvenor-square, surveyor; for a new method of constructing chimneys, and of supplying fires with fuel. Nov. 1, 1816.

BENJAMIN SMYTHE, of Liverpool, schoolmaster; for a machine or apparatus, or a new method or methods of propelling vessels, boats, barges, and rafts of all kinds; and also other machinery, as mill-wheels, and other revolving powers. Nov. 1, 1816.

WILLIAM DAY, of the Strand, trunk-maker; for various improvements in or on trunks; and also in the application of certain machinery, by means of which machinery they will contract or expand at pleasure. Nov. 1, 1816.

WILLIAM SNOWDEN, of Doncaster, clerk; for an apparatus or machine to be attached or applied to carriages, to prevent them from being overturned. Nov. 1, 1816.

SIMON HOSKINS, of St. Phillack, Cornwall, cabinet-maker; for a steam-engine upon a new construction, for drawing water from mines for working different kinds of machinery, and for other purposes for which steam-engines are in general applied. Nov. 1, 1816.

GEORGE WASHINGTON DICKINSON, of Great Queen-street, Lincoln's Inn Fields, gentleman; for a method, means, or contrivance, for preventing leakage from vessels employed to contain liquids; and for preventing the admission of moisture into packages or vessels intended to be kept dry within. Nov. 1, 1816.

JOHN HEATHCOAT, of Loughborough, lace-manufacturer; for improvements upon machines or machinery, invented and in use for the purpose of making that kind of lace commonly known by the name or distinguished by the names of bobbin net, or Buckinghamshire lace net. Nov. 1, 1816.

WILLIAM PIERCY, Birmingham, tortoise-shell-maker; for a method of making thimbles. Nov. 1, 1816.

JOHN DAY, of Brompton, near London, Lieutenant on half pay of the eleventh regiment of foot; for improvements and additions in the construction of piano-fortes, and other keyed musical instruments. Nov. 1, 1816.

ROBERT STIRLING, of Edinburgh, clerk; for diminishing the

consumption of fuel, and in particular an engine capable of being applied to the moving machinery, on a principle quite new. Nov. 1, 1816.

ROBERT RAINES BAINES, of Myton, in the county of the town of Kingston-upon-Hull, glue manufacturer; for a perpetual log or sea perambulator. Nov. 16, 1816.

WILLIAM RUSSELL, of Avery Farm-row, Chelsea, engineer; for an improvement upon cocks and vents for general purposes, particularly useful to brewers, distillers, private families, &c. Nov. 19, 1816.

JOHN BARKER, of Cottage Green, Camberwell, artist; for an improvement or improvements in the method or means of acting upon machinery. Nov. 19, 1816.

ROBERT FORD, late of Barbican, but now of Crouch End, near London, chemist; for a medicine for the cure of coughs, colds, asthmas, and consumptions, which he names "Ford's Balsam of Horehound." Nov. 21, 1816.

WALTER HALL, of Serjeant's Inn, merchant; for a method or methods of making soft lead out of hard lead, or slag lead. Communicated to him by certain foreigners residing abroad. Nov. 21, 1816.

JAMES KEWLEY, of Aldersgate-street, gentleman; for improvements in and on thermometers. Nov. 21, 1816.

RICHARD WRIGHT, of Bishopsgate-street Within, London; for improvements in the construction and propelling ships and other vessels. Dec. 10, 1816.

WILLIAM DEAN, of Manchester, calico-glazier; for machinery for waxing calico, or any other cloth or fabric, previous to the process of glazing. Dec. 14, 1816.

ARTICLE XVI.

Scientific Books in hand, or in the Press.

Dr. Scudamore is printing an enlarged edition of his *Treatise on the Nature of Gout and Rheumatism*.

Mr. C. C. Bompas is about to publish an *Essay on Light, Heat, and Electricity*.

A Translation of Orfila's *Treatise on Chemistry* is about to be published.

Dr. Marshall Hall will shortly publish the *Principles of Diagnosis*, founded entirely on the external Appearances of the Disease.

A Sketch of the History and Cure of Febrile Diseases, particularly those of the West Indies, by Dr. Robert Jackson.

ARTICLE XVII.

Magnetical and Meteorological Observations.

By Col. Beaufoy, F.R.S.

Bushey Heath, near Stanmore.

Latitude 51° 37' 42" North. Longitude west in time 1' 20.7".

Magnetical Observations, 1817. — Variation West.

Month.	Morning Observ.			Noon Observ.			Evening Observ.					
	Hour.	Variation.			Hour.	Variation.			Hour.	Variation.		
May 1	8h 45'	24°	33'	54''	1h 45'	24°	44'	58''	6h 50'	24°	35'	48''
2	8 45	24	36	48	1 45	24	46	47	—	—	—	—
3	8 40	24	30	29	1 45	24	40	58	6 45	24	35	17
4	8 45	24	30	55	1 45	24	42	10	6 45	24	31	35
5	8 45	24	32	08	1 45	24	42	28	6 45	24	33	45
6	8 40	24	31	00	1 45	24	40	30	6 45	24	34	46
7	8 40	24	31	28	1 45	24	40	09	6 45	24	32	58
8	8 45	24	34	10	1 45	24	39	08	6 55	24	35	40
9	8 45	24	33	11	1 45	24	38	41	6 45	24	36	17
10	8 35	24	32	00	1 45	24	44	36	—	—	—	—
11	8 45	24	32	54	1 45	24	44	02	6 45	24	35	11
12	8 45	24	30	33	1 45	24	42	24	—	—	—	—
13	8 45	24	32	25	1 55	24	40	02	6 45	24	35	06
14	8 45	24	33	09	1 45	24	42	36	6 45	24	34	25
15	8 45	24	33	28	1 45	24	41	23	6 45	24	35	24
16	8 40	24	33	54	1 40	24	42	08	6 45	24	34	53
17	8 35	24	31	31	1 40	24	44	00	6 45	24	34	40
18	8 40	24	31	20	1 45	24	45	26	6 45	24	36	36
19	8 40	24	32	03	1 40	24	44	22	—	—	—	—
20	—	—	—	—	1 50	24	42	53	—	—	—	—
21	—	—	—	—	—	—	—	—	6 40	24	34	18
22	8 40	24	31	51	1 45	24	39	43	6 45	24	34	17
23	8 35	24	31	53	1 45	24	44	09	6 45	24	35	12
24	8 40	24	32	41	1 55	24	42	18	6 55	24	33	28
25	8 40	24	32	02	1 55	24	45	46	6 55	24	35	35
26	8 25	24	32	33	1 45	24	42	01	6 50	24	35	32
27	8 40	24	31	54	1 35	24	40	06	6 50	24	35	07
28	8 40	24	33	19	1 45	24	41	00	6 50	24	35	00
29	8 40	24	33	56	1 40	24	40	16	6 45	24	33	34
30	8 40	24	28	46	1 40	24	47	16	6 50	24	34	58
31	8 40	24	31	07	1 40	24	45	16	6 50	24	34	03
Mean for Month.	8 41	24	32	20	1 45	24	42	35	6 47	24	34	45

On the 12th, in the evening, the needles were too unsteady for an observation.

Meteorological Table.

Month.	Time.	Barom.	Ther.	Hyg.	Wind.	Velocity.	Weather.	Six's.
		Inches.				Feet.		
May 1	Morn....	29.440	41°	66°	N		Cloudy	
	Noon....	29.457	44	59	NNE	16.166	Cloudy	46°
	Even....	29.505	42	58	NNE		Cloudy	} 39
Morn....	29.544	43	56	N		Fine		
2	Noon....	29.540	50	47	NE	16.244	Fine	56
	Even....	—	—	—	—	—	—	
3	Morn....	29.485	50	49	W by N		Fine	} 43
	Noon....	29.423	54	43	W by N	15.545	Cloudy	
	Even....	29.375	48	45	W		Cloudy	} 40
Morn....	29.390	53	53	NW by W		Fine		
4	Noon....	29.440	57	41	WNW	16.949	Fine	59
	Even....	29.541	51	42	NW		Fine	} 41
Morn....	29.643	53	46	SSW		Clear	} 64	
5	Noon....	29.638	62	37	SSW	16.987		Clear
	Even....	29.620	55	42	SW by S		Clear	} 41
Morn....	29.705	57	50	NW		Fine	} 65	
6	Noon....	29.160	60	45	N	8.239		Fine
	Even....	29.788	53	42	NNE		Clear	} 39
Morn....	29.845	52	40	E		Clear	} 61	
7	Noon....	29.758	60	35	E by S	21.646		Clear
	Even....	29.670	55	42	E		Clear	} 41
8	Morn....	29.430	56	52	NNE		Fine	
	Noon....	29.390	68	54	NE	9.634	Fine	
	Even....	29.304	54	56	E		Fine	} 43
9	Morn....	29.363	49	54	NE by E		Fine	
	Noon....	29.325	55	51	NE by E	17.253	Fine	
10	Even....	29.285	50	54	NE		Cloudy	} 41
	Morn....	29.107	49	64	SSW		Cloudy	
11	Noon....	29.043	57	50	SSW	19.368	Cloudy	58
	Even....	—	—	—	—	—	Rain	} 39
	Morn....	29.075	48	54	NW by W		Fine	
12	Noon....	29.090	56	38	WSW	18.633	Fine	55
	Even....	29.090	49	52	SW		Cloudy	} 43
	Morn....	28.900	50	62	W by S		Showery	
13	Noon....	28.935	55	45	W by S	30.414	Fine	56
	Even....	29.010	45	58	W by N		Showery	} 37
Morn....	29.252	48	50	W		Fine	} 55	
14	Noon....	29.300	51	50	W by N	19.832		Fine
	Even....	29.300	47	63	SW by S		Drizzle	} 41
	Morn....	29.208	46	69	SE		Drizzle	
15	Noon....	29.212	55	52	SW by S	21.082	Fine	56
	Even....	29.258	46	60	WSW		Showery	} 41
Morn....	29.347	51	54	W		Fine	} 61	
16	Noon....	29.392	58	44	W	7.184		Fine
	Even....	29.447	51	56	WNW		Fine	} 40
Morn....	29.545	55	53	WSW		Clear	} 63	
17	Noon....	29.515	62	37	Var.	5.026		Fine
	Even....	29.480	54	44	E		Fine	} 45
	Morn....	29.435	55	51	SSW		Cloudy	
18	Noon....	29.425	54	42	SSW	8.522	Cloudy	66
	Even....	29.362	57	44	SW		Fine	} 49
Morn....	29.215	59	54	E		Cloudy	} 68	
Even....	29.100	65	48	ENE	9.196	Cloudy		
	Even....	29.055	58	70	WNW		Cloudy	

Meteorological Table continued.

Month.	Time.	Barom.	Ther.	Hyg.	Wind.	Velocity.	Weather.	Six's.
		Inches.				Feet		
May 19	Morn....	29.078	49°	62°	NNE		Cloudy	45*
	Noon....	29.080	54	53	NE by E	15.898	Rain	55
	Even....	29.065	54	73	NE		Rain	} 37
Morn....	29.060	44	96	NE		Rain		
20	Noon....	29.050	49	80	NE by N	16.200	Cloudy	40
	Even....	29.050	46	84	NE by N		Rain	} 43
21	Morn....	28.982	44	94	NNE		Rain	
	Noon....	—	—	—	—	—	Rain	49
22	Even....	29.000	43	75	W		Drizzle	} 40
	Morn....	29.013	44	68	WSW		Cloudy	
	Noon....	29.025	49	58	W by S	7.512	Cloudy	50
23	Even....	29.023	45	65	W by N		Showery	} 41
	Morn....	29.050	48	60	W by N		Cloudy	
	Noon....	29.045	57	47	W	4.945	Fine	59
24	Even....	29.045	49	63	WSW		Fine	} 40
	Morn....	29.085	43	59	SW		Fine	
	Noon....	29.080	52	55	W	9.741	Showery	57
25	Even....	29.070	50	54	SSW		Fine	} 43
	Morn....	28.900	50	73	E		Showery	
	Noon....	28.847	50	75	ESE	12.673	Showery	53
26	Even....	28.806	50	70	ENE		Fine	} 47
	Morn....	28.763	53	68	SE by E		Cloudy	
	Noon....	28.818	58	49	SE	12.894	Cloudy	58
27	Even....	28.880	51	59	ESE		Fine	} 45
	Morn....	29.000	55	65	E		Fine	
	Noon....	29.056	59	52	SE	9.111	Fine	59
28	Even....	29.105	53	54	S		Fine	} 44
	Morn....	29.225	56	52	Var.		Fine	
	Noon....	29.243	55	61	NNE	7.991	Cloudy	61
29	Even....	29.260	53	63	WNW		Showery	} 47
	Morn....	29.185	48	86	N		Showery	
	Noon....	29.225	47	83	NNE	17.970	Showery	48
30	Even....	29.295	45	76	N		Drizzle	} 42
	Morn....	29.424	46	54	N		Fine	
	Noon....	29.443	50	54	N	10.915	Fine	54
31	Even....	29.460	46	53	NNE		Cloudy	} 37
	Morn....	29.485	46	54	NW		Fine	
	Noon....	29.482	50	48	NNW	9.327	Cloudy	55
	Even....	29.382	49	49	W		Fine	

Column Six's contains opposite Noon the greatest degree of heat between the morning and evening observation; and then follows the least degree of heat between the evening and morning observation, and so on.

On the 23d, at four o'clock, P. M. thunder was heard in the south-east.

ARTICLE XVIII.

METEOROLOGICAL TABLE.

1817.	Wind.	BAROMETER.			THERMOMETER.			Hygr. at 9 a. m.	Rain.
		Max.	Min.	Med.	Max.	Min.	Med.		
5th Mo.									
May 8	Var.	29·72	29·68	29·700	72	42	57·0	49	8 C
9	N E	29·68	29·49	29·585	54	37	45·5	59	
10	S W	29·43	29·35	29·390	60	38	49·0	45	—
11	Var.	29·35	29·23	29·290		43		48	·15
12	W	29·63	29·23	29·430				45	—
13	S W	29·63	29·59	29·610	59	34	46·5	58	·13
14	W	29·74	29·59	29·665				41	·45
15	S W	29·90	29·74	29·820	62	33	47·5	49	
16	Var.	29·90	29·80	29·850	65	33	49·0	50	
17	S W	29·80	29·55	29·675	67	39	53·0	42	1
18	S E	29·43	29·36	29·395	72	44	58·0	53	·11
19	N E	29·46	29·43	29·445	53	38	45·5	67	—
20	N E	29·42	29·34	29·380	52	43	47·5	80	—
21	N E	29·42	29·40	29·410	48	38	43·0	59	—
22	S W	29·42	29·40	29·410	57	40	48·5	50	1·44
23	W	—	—	—	—	—	—	—	—
24	N E	29·40	29·27	29·335	62	35	48·5	65	·18 D
25	S E	29·19	29·16	29·175	57	45	51·0	58	·29
26	E	29·37	29·17	29·270	63	41	52·0	44	
27	N E	29·59	29·35	29·470	69	38	53·5	53	
28	N E	29·59	29·56	29·575	59	47	53·0	77	
29		29·80						51	—
30		29·90							·23 O
31		29·75	29·68	29·715	59	33	46·0	50	
6th Mo.									
June 1	S W				63	42	52·5	41	
2	W	29·64	29·58	29·610	64	46	55·0		
3	W	29·59	29·45	29·520	64	52	58·0		
4	W	29·99	29·45	29·720	65				
5	S W	29·91	29·89	29·900	65	47	56·0	54	·11
		29·99	29·16	29·533	72	33	50·70	54	3·18

The observations in each line of the table apply to a period of twenty-four hours, beginning at 9 A. M. on the day indicated in the first column. A dash denotes, that the result is included in the next following observation.

REMARKS.

Fifth Month.—8. *Cirrocumulus*, mixed with *Nimbi*, a.m. after which, the cloudiness becoming general, a thunder-storm ensued, soon after four, p.m.: it came from the SW, with the wind at SE. 9. Cold wind, a.m. with a general cloudiness. 10. Overcast, a.m. with *Cumulostratus*: a few drops of rain. 11. *Cumulus*, *Cumulostratus*, and *Nimbus*: the wind NW and SW: rain with wind at night from the southward. 12, a.m. A westerly gale. 13. Showery, with hail twice. 14. Showery: hail, pretty large, at noon from the southward. 15, 16. Fair. 17. A shower, p.m.—Travelling in the interval from the 13th to the 17th inclusive as far as Leeds, in Yorkshire, and home again, I found cloudiness from large *Cumuli*, &c. general, but met with very little rain. On the 15th, passing between Leeds and Pontefract, there was a fine display of *Nimbi*, one of which let fall a heavy shower on the latter place and its environs. On the 17th, after a deep orange tint in the morning twilight, the sun rose red behind a *Cirrostratus*; in emerging from which the brilliant part of the disc was divided by a well-defined line from the lower and coloured portion.—18. Cloudy, a.m.: gentle rain, p.m. 19. Windy, cloudy, a.m.: wet, p.m. 20, 21. Rainy. 22. Cloudy. 23, 24. Some showers: a *Stratus* at nine, p.m. the latter day. 25. Thunder at a distance: showers, a.m. 27. A thick fog at night, undoubtedly from a *Stratus*.

RESULTS.

Winds variable, but for the most part westerly.

Barometer: Greatest height 29.99 inches

Least 29.16

Mean of the period 29.533

Thermometer: Greatest height 72°

Least 33

Mean of the period 50.70

Mean of the hygrometer, 54°. Rain, 3.18 itt.

I had anticipated a *third* dry period, similar to the two we had experienced, and expected that the rains would return after the summer solstice: in this I have been happily mistaken. In the beginning of the present period the weather took a new type with us, the westerly current coming in again, with some discharges of electricity, bringing rain, which gradually became more plentiful, and proved exceedingly seasonable. Vegetation has passed, in consequence, from a starved and backward state, to one of considerable luxuriance and promise. It is observable that the barometer during this period has scarcely passed the boundary of 30 in. in elevation, and has certainly not descended below 29 in. The mean temperature, though 6° higher than that of the period immediately preceding, is low for the season.

TOTTENHAM,
Sixth Month, 17, 1817.

5

L. HOWARD.

ANNALS
OF
PHILOSOPHY.

AUGUST, 1817.

ARTICLE I.

Biographical Account of M. Rochon.

ON April 7, 1817, was buried M. Rochon (Alexis-Marie), member of the Royal Academy of Sciences. After the funeral service, M. Girard, Member of the Academy, delivered the following discourse:—

“ GENTLEMEN,

“ Till a more worthy honour be paid to the memory of our fellow-associate, whom we deposite this day in the tomb, I hope I may be permitted to raise my voice for a few moments to call to your recollection his labours and his services. May the expression of our regret bring some consolation to the melancholy duty which we have just discharged!

“ M. Rochon was born at Brest on Feb. 21, 1741. This harbour, and the vessels with which it was filled, were the first objects that attracted his attention. Surrounded from his youth with sailors and voyagers, their conversation decided his taste, and the progress of natural science became the special object of the whole labours of his life.

“ He was named Correspondent of the Academy of Sciences in 1765. To this title he soon added that of Astronomer to the Navy, and in this quality he made a voyage to Morocco in 1767. Immediately after his return he set out for the East Indies in a vessel commanded by M. de Tromelin, his relation and friend. He determined in 1769 the position of the islands and rocks situated be-

tween the coasts of India and the Isle of France. He returned from that colony in 1772 with M. Poivre, that administrator whose wisdom and talents have left in his jurisdiction so high a reputation.

“ M. Rochon brought from that expedition the most beautiful crystals of quartz from Madagascar that had been at that time seen. He got some pieces of them cut, ascertained the double refraction which it possesses, and conceived the happy idea of applying it to the measurement of angles. Such is the origin of the ingenious micrometer, for the invention of which we are indebted to him.

“ Nobody knew better than our associate the wants of the province in which he had been born, and what was necessary to increase its prosperity; but the harbour of Brest fixed his constant predilection. Government approved of the plan which he proposed of cutting across Brittany a navigable canal between Brest and Nantes, which would in time of war serve to convey provisions without any risk to the first of our naval arsenals. The memoirs of M. Rochon on this important subject have the rare merit of pointing out at once the advantages, the difficulties to be overcome, and the means of surmounting them.

“ M. Rochon fully enjoyed during the whole of his life that reputation which his labours had justly acquired for him. He knew equally well how to make science useful in the society of men of the world with whom he was associated, and to render its application easy in the workshops of most of those arts with the processes of which he was familiar. It was by the utility of discoveries that he estimated their importance; and when a few days ago we heard him for the last time, at one of our meetings, it was to offer to the Academy the tribute of a useful investigation.

“ He was then in his 77th year. His strong constitution, though he had become a good deal weaker for some months past, left us the hope of preserving him, even when we heard that he was attacked by the disease under which he sunk.

“ After he had reached a mature age, M. Rochon had united himself with a widow lady, a relation of his own, and mother of two children. This union was during 25 years the source of mutual happiness, which was destroyed for ever by the fatal event which has collected us together—an event aggravated for his family by a deplorable circumstance. His respectable widow was obliged to divide her attention between her husband and her daughter, who were both seized at the same time with a fatal disease. Her care of both was useless, her vows were unavailing. The same instant deprived her of two objects, both most dear to her affections, and left her plunged in the deepest sorrow which virtue is capable of supporting.”

ARTICLE II.

Appendix to the Essay on the Chemical Compounds of Azote and Oxygen. By John Dalton.

(Concluded from p. 47.)

CLASS III.—*Experiments over Mercury with Caustic Alkalies.*

GAY-LUSSAC having recently stated that mixtures of nitrous and oxygen gases over mercury to which caustic alkali was admitted exhibited always the same proportions of oxygen and nitrous gas; namely, one measure of oxygen uniting to four of nitrous gas; I was desirous to try if I could succeed in producing the union in like circumstances; for which purpose I made the following experiments:—

1. To 133 measures of nitrous gas of 97 per cent. = 129 real, 4 azote, put 32 measures caustic soda of 1.11 sp. gr. No diminution in two hours.

Put 16 of 72 per cent. oxygen = 11.5 real, 4.5 azote.

149

102 in a few minutes, and remaining so for more than one hour.

Put 16 more oxygen of same kind.

118

79 in a few minutes.

78 in 8 or 10 hours.

76 in 1 day.

75 in $1\frac{1}{4}$

75 in 2

75 transferred, 63 nitrous by sulphate of iron.

This gives 1 oxygen to 2.91 nitrous gas.

2. To 240 of 97 nitrous gas put 32 caustic potash of 1.45 sp. gr. It stood 12 hours without any change.

Put 60 of 78 oxygen = 47 real, 13 azote.

300

155 in a few minutes.

152 soon after.

141 in 12 hours.

133 in 24

133 in 48

130 transferred over water, 109 nitrous.

This gives 1 oxygen to 2.55 nitrous. The loss of 3 nitrous was occasioned chiefly by passing through the water as usual.

It is obvious that these experiments are far from according with

those of Gay-Lussac; and as he has not given us the detail of his, I cannot suggest the cause of the difference. My reason for subjecting the nitrous gas in the first place to the action of the alkalies was to show that these do not act on nitrous gas alone; and I had some ground for this; for in my first trials I had obtained a much greater reduction of the nitrous gas; but upon examination I found my potash contained a little sulphureted hydrogen, and this converted a part of the nitrous gas into nitrous oxide, and in this way reduced its volume. This was proved by admitting nitrous gas alone to the potash, when it was gradually reduced in volume, as if oxygen had been present; but when the residue was examined, it diminished rapidly, by passing a few times through water, and then left a residue of nitrous gas.

CLASS IV.—Experiments on the Analyses of Nitrous Gas, Nitrous Oxide, and Ammonia, by exploding their Mixtures over Mercury.

Proust, I believe, was the first person who pointed out the analysis of ammonia, by exploding it with oxygen in Volta's eudiometer. (*Jour. de Phys.* 1799, vol. xlix.) A. B. Berthollet used the process in 1808, and Dr. Henry in 1809. On these modes of analysis I have already animadverted (*Chemistry*, p. 434), and have seen no reason since for changing my opinions. Dr. Henry at the same time discovered that the analysis of ammonia was capable of being effected by nitrous oxide and nitrous gas severally as well as by oxygen. This was scarcely to have been expected, especially by nitrous gas, which is not decomposed by hydrogen alone; but it should seem that the azote of the ammonia, repelling that of the nitrous gas, contributes to the separation of the elements as much perhaps as the attraction of the oxygen for the hydrogen. Whatever may be the true explanation, the fact is a curious and important one; namely, that two compounds, in each of which azote is an element, mutually decompose each other, the oxygen of the one uniting to the hydrogen of the other, and the azote of both being liberated. It may enable us to investigate the proportions of the constituents in both compounds.

If chemists were agreed respecting the composition of one of the two compounds in such mixtures (namely, nitrous gas and ammonia), it would be an easier task to ascertain that of the other; but unfortunately the proportions in both are yet subject to dispute. Gay-Lussac, and I apprehend some others, hold that 100 measures of ammoniacal gas are constituted of 50 azote and 150 hydrogen; whereas, according to my experiments, as well as those of Davy and Henry (see my *Chemistry*, p. 429, 430, 432), 100 ammonia produce only 186, or from that to 190, of mixed gases by electricity; of which I find 28 or 29 per cent. azote, and the rest hydrogen.

For the sake of those who may not be much conversant in this subject, it may be proper further to state that, supposing (for instance) nitrous gas and ammoniacal gas to be mixed in such proportions as, when fired, they may be mutually saturated, by which

we mean the oxygen of the one may saturate the hydrogen of the other, and the azote of both be liberated, then, according to Gay-Lussac,



and they require

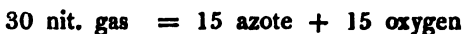

for their saturation; but, according to my view,



and require nearly

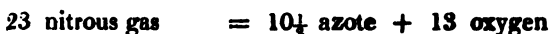

for their saturation; all the numbers being understood to denote measures. That is, if a given volume of azote be united to oxygen so as to form nitrous gas, and the same volume of azote be united to hydrogen to form ammonia; then the oxygen of the one will just equal the hydrogen of the other to form water. But it is otherwise in Gay-Lussac's view; for he insists that one-third of the hydrogen will remain in excess.

In mixtures of nitrous oxide and ammonia the disproportion between us is still greater; for, according to Gay-Lussac,

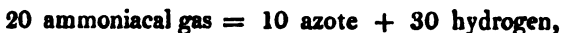

and they require



for saturation; but my view is, that



and that they require

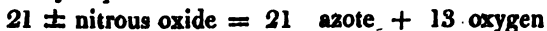

for saturation; that is, the azote of the nitrous oxide is *double* that of the ammonia, whereas Gay-Lussac says it is *triple*.

No detail of experiments on the mutual decomposition of the nitrous compounds and ammonia has been published that I know of, besides that of Dr. Henry soon after the discovery; and it is professedly too limited for a complete exposition of the facts.

Dr. Henry has only selected one experiment on the decomposition of nitrous oxide and ammonia, the result of which he has explained according to the facts previously discovered by Davy and himself, as the above two theoretic views were not then published. We shall now see whether it supports either of them.

41 measures ammoniacal gas.

38 pure nitrous oxide.

together 79

78 when fired; and then found to consist of 16 hydrogen + 57 azote.

According to the theory of volumes,

41 ammoniacal gas = $20\frac{1}{2}$ azote + $61\frac{1}{2}$ hydrogen
and 38 nitrous oxide = 38 azote + 19 oxygen.

There should then be found $58\frac{1}{2}$ azote + $23\frac{1}{2}$ hydrogen, instead of 57 azote and 16 hydrogen.

But, according to my view,

41 ammoniacal gas = 21 azote + 53 hydrogen
and 38 nitrous oxide = 38 azote + $23\frac{1}{2}$ oxygen.

There should then be found 59 azote + 6 hydrogen, instead of 57 azote and 16 hydrogen.

Here both theories appear at variance with experiment, and mine rather more of the two; but the accuracy of the experiment cannot fairly be doubted. We must, therefore, see which theory can be most easily bent to accommodate it,

According to Dr. Henry, when the nitrous oxide is in excess, there is evidence of nitrous or nitric acid being formed; and I have reason to suppose, further, that in every explosion, whatever may be the proportions, less or more of the acid is formed; because I always find a small diminution of the residuary gas on passing it through water. This being admitted, we are to see how the supposition will influence the preceding calculations. It will evidently decrease the residuary azote, and increase the hydrogen. Let us suppose that two measures azote unite to five oxygen, forming the coloured or mixed acid; then will the residuary gas on my hypothesis be found to be 57 azote + 16 hydrogen, exactly agreeing with the experiment; but the residuary gas, according to Gay-Lussac, would be $56\frac{1}{2}$ azote + $33\frac{1}{2}$ hydrogen, differing from the experiment by $17\frac{1}{2}$ measures of hydrogen. The error increases as the quantity of acid increases; and I cannot conceive any probable cause to be assigned for the differences observed upon this hypothesis.

Two experiments on the mixture of nitrous gas and ammonia are related by Dr. Henry in the paper above referred to:—

1. Ammonia 48 measures.

Nitrous gas .. 53

101 fired, left 54 azote + 9 hydrogen.

2. Ammonia 60 measures.

Nitrous gas .. 36

96 fired, left $48\frac{1}{2}$ azote + $30\frac{1}{2}$ hydrogen and 10 ammonia.

Before adverting to these experiments, I may observe that the quantity of ammonia present in any experiment, even if measured in the detonating tube, is very uncertain. Such is the effect of the smallest unperceived moisture in the tube or mercury, that I have known 30 measures of ammonia decomposed when there were only

20 present *apparently*. The real quantity of ammonia may be equal to or greater than the apparent, but cannot be less. The quantity decomposed must, therefore, often be inferred from the results; and the azote is the best guide, because it is that article about which the two theories differ least, my view requiring more azote in the ammonia, and less in the nitrous gas, such as usually to produce nearly a compensation.

Assuming, then, in the first experiment, that 54 measures of ammonia were decomposed, instead of 48, the explanation on the two hypotheses will run thus:—

Volume theory 54 ammoniacal gas = 27 azote + 81 hydrogen
 53 nitrous gas = $26\frac{1}{2}$ + $26\frac{1}{2}$ oxygen.

There should then be found $53\frac{1}{2}$ azote + 28 hydrogen, instead of 9 hydrogen, as observed; and the azote account is still rather too little, notwithstanding the assumption.

Atomic theory 54 ammoniacal gas = $28\frac{1}{2}$ azote + 69 hydrogen
 53 nitrous gas = 24 + 30 oxygen,

and there will be found $52\frac{1}{2}$ azote + 9 hydrogen.

This agrees with the observation in regard to hydrogen, but is rather below in azote; if we may suppose one azote in the ammoniacal gas (a very probable supposition), it will then bring the azote up to within $\frac{1}{2}$ measure of the observed quantity, and will not be detrimental to the other theory.

In the second experiment, assuming 58 ammoniacal gas decomposed, instead of 40, we have

Volume theory 58 ammoniacal gas = 29 azote + 87 hydrogen
 36 nitrous gas = 18 + 18 oxygen,

and there will be found 47 azote + 51 hydrogen. Here the azote being $1\frac{1}{2}$ too little, we cannot have assumed too much ammonia for this theory, and yet the hydrogen is $20\frac{1}{2}$ measures in excess.

Atomic theory 58 ammoniacal gas = $30\frac{1}{2}$ azote + 74 hydrogen
 36 nitrous gas = $16\frac{1}{2}$ + $20\frac{1}{2}$ oxygen,

and there will be found 47 azote + 38 hydrogen, instead of $48\frac{1}{2}$ azote and $30\frac{1}{2}$ hydrogen. If we may suppose $1\frac{1}{2}$ azote in the ammoniacal gas, both the hypotheses will accord with observation in the azote, but the former will have an excess of $20\frac{1}{2}$ in the hydrogen, and the latter an excess of $2\frac{1}{2}$ measures.

Hence we may see how far Dr. Henry's experiments support the two systems as far as regards the compounds, nitrous oxide, nitrous gas, and ammonia. I shall now advert to my own experiments on the same subjects.

Nitrous Oxide and Ammonia, &c.

I have lately made about 30 experiments on the deflagration of ammonia, hydrogen, sulphureted hydrogen, and carbureted hydro-

gen, severally with nitrous oxide over mercury. My nitrous oxide was usually procured from nitrous gas by sulphuret of potash or of lime.

Nitrous gas of a known degree of purity was put into a graduated two-ounce bottle over water, so as to fill it. This was transferred to the mercurial trough, where about 10 gr. of dry sulphuret of potash were admitted to the gas; an absorption of oxygen and diminution of gas soon commenced; in a little time 20 or 30 gr. of water were admitted, so as to dissolve the sulphuret, and then by moderate agitation the process was finished in 10 or 15 minutes, as was shown by the cessation of absorption. Sometimes 100 gr. of liquid sulphuret of lime was substituted for that of potash. The gas was then transferred, and dried by blotting paper, and found to contain no nitrous gas, but only nitrous oxide, and the residue of azote in the nitrous gas. In one or two instances the azote seemed rather increased; but whether from a decomposition of the nitrous oxide, or from a little atmospheric air acquired in the manipulation, I could not ascertain. I was careful to mark the diminution of the nitrous gas when converted into nitrous oxide this way. It was always more than half of the original volume of nitrous gas, allowing for the azote. The average reduction of the pure nitrous gas was from 100 to 45, the same as Davy determined long ago. This fact opposes Gay-Lussac's theory of volumes, as the reduction according to it should be 50 per cent.; but it accords with the high specific gravity of nitrous oxide (1.61) as determined by Davy, and with its constitution such as I have above maintained.

Nitrous Oxide and Hydrogen.—Davy, in his Researches, has given us some good experiments on this head. He found that nitrous oxide explodes with hydrogen when mixed in a great variety of proportions. When the hydrogen exceeds, little or no nitrous acid is formed; but if the nitrous oxide exceeds, then not only water, but nitrous acid, and much free oxygen, are found after the explosion. I have made more than 12 experiments on this mixture, and find that when the hydrogen a little exceeds the oxide in volume the consumption of hydrogen is very nearly equal in volume to the nitrous oxide; but there is always found a trace of nitrous acid, manifested by a loss of one or two measures on transferring the residuum over water. If the hydrogen is considerably in excess, then more hydrogen is generally spent than is equal to the volume of nitrous oxide. If the nitrous oxide is in great excess, all the hydrogen disappears, oxygen sometimes to the amount of 10 or 12 per cent. is found in the residuum, and nitrous or nitric acid is manifest by a variety of means, and consequently a considerable loss of azote.

Nitrous Oxide and Sulphureted Hydrogen.—I find that 20 sulphureted hydrogen recently made from muriatic acid and sulphuret of antimony require nearly 30 oxygen for their combustion; that is, 10 for the hydrogen and 20 for the sulphur. It would seem

from the following experiment that 20 sulphureted hydrogen required nearly 48 nitrous oxide.

19 + sulphureted hydrogen = 18 + pure.
58 nitrous oxide = 46 real + 1 oxygen + 11 azote.

77

66 fired.

54 washed. No oxygen nor hydrogen.

Here we find 54 azote, instead of 57 or 58. This deficiency most probably was occasioned by a residuum of nitrous oxide which the water abstracted. According to Gay-Lussac's theory, 20 sulphureted hydrogen would require 60 nitrous oxide.

Nitrous Oxide and Carbureted Hydrogen.—I made two experiments on this mixture. Eleven parts pure carbureted hydrogen were exploded with 39 pure nitrous oxide; in all 50; when fired, 50 residue washed in lime-water left 41, of which one or two were hydrogen. Ten pure carbureted hydrogen fired with 45 nitrous oxide gave 59; washed in lime-water, left 43, of which $1\frac{1}{2}$ were oxygen. In this last experiment there was evidently an excess of nitrous oxide, besides the redundant oxygen; but these experiments are too few to decide a theoretic question.

Nitrous Oxide and Ammonia.—Mixtures of nitrous oxide and ammonia will explode if the ammonia does not exceed the oxide. The results are azote, water, hydrogen, and a little trace of nitrous acid, if the ammonia be in excess; but if the other gas be in excess, then we obtain azote, water, oxygen, and considerable nitrous acid. The three following experiments exhibit the chief varieties:—

1. 50 nitrous oxide of 84 per cent. = 42 real + 8 azote
made 86 by ammonia of 99 per cent. pure; tube rather moist;
stood 15 minutes to be well mixed.

78 fired.

75 $\frac{1}{2}$ washed, 3 hydrogen, 72 $\frac{1}{2}$ azote.

Here if we suppose 50 nitrous oxide to produce 50, or nearly 50 azote (a point upon which we are agreed), there will remain 22 $\frac{1}{2}$ azote to be accounted for from the decomposition of ammonia = 45 ammonia by Gay-Lussac = 67 $\frac{1}{2}$ hydrogen; from which taking three, there remain 64 $\frac{1}{2}$ to be converted into water by the oxygen of the nitrous oxide = 21; but this would leave 22 $\frac{1}{2}$ hydrogen unsupplied, and hence sufficiently shows the inadequacy of the hypothesis. On my view 22 $\frac{1}{2}$ azote come from 44 ammonia, and these give 57 hydrogen, from which taking three, there remain 54 to be supplied with oxygen. Now 42 nitrous oxide at the rate of 62 per cent. oxygen yield 26 oxygen, being only one less than the experiment requires.

2. $69 \frac{1}{2}$ nitrous oxide = 53 real + 2 oxygen + $14 \frac{1}{2}$ azote.
45 ammonia 99 per cent.

114

96 fired.

94 washed. No hydrogen nor oxygen.

Here the nitrous oxide must have introduced $67 \frac{1}{2}$ azote. Hence about 26 azote must have come from the ammonia, which, therefore, would not be less than $51 = 66$ hydrogen = 33 oxygen. It should have been 34 by the atomic theory. Probably a minute portion of nitric acid was the cause of the error. But if we adopt the volume theory, there would have been a redundancy of 19 hydrogen.

3. 25 ammoniacal gas, 99 per cent.
53 nitrous oxide, 84 = $44 \frac{1}{2}$ real + $8 \frac{1}{2}$ azote.

78

76 when mixed.

$71 \frac{1}{2}$ fired.

70 washed, $4 \frac{1}{2}$ or 5 oxygen, 65 azote.

Here supposing 25 to have been the real ammonia, they would produce, according to my views, 13 azote and 32 hydrogen = 16 oxygen, to which, adding 5, we have 21; but the nitrous oxide would give 27 oxygen; hence a redundancy of six oxygen; the azote should have been 66 or 67, instead of 65; but I presume that two azote and six oxygen united to form nitric or nitrous acid. According to the other view, in 25 ammonia there would be $37 \frac{1}{2}$ hydrogen = 19 oxygen, and there would be only three oxygen left in the residue instead of five, not allowing any for nitrous acid, though there are marks of it in every instance, at least when oxygen is in the residue.

Of eight experiments on nitrous oxide and ammonia, four, on the accuracy of which I could most rely, accorded with the atomic system, and were inimical to the others: the other four were of a more ambiguous nature, and might be explained upon either principle. One chief cause of their results differing from the general tenor was, I believe, in the explosions being made before the mixtures had stood the due time to become uniform. In a long small tube the mixture should stand at least five minutes previously to the explosion.

Nitrous Gas and Ammonia.—I made upwards of 20 experiments on mixtures of nitrous gas and ammoniacal gas in various proportions, from 10 nitrous to 3·8 ammonia, to 10 nitrous with 14 ammonia, which are very nearly the limits to the explosion of this kind of mixture. The results are by no means so decisive with regard to the two theories as those with nitrous oxide; because any result that could fairly arise from either theory may very readily be

adapted to the other, without any assumption that can be shown as improbable, in two cases out of three, namely, when the residue contains oxygen, and when it contains neither oxygen nor hydrogen. For instance,

Suppose 20 ammoniacal gas, measured in the exploding tube.
 30 nitrous gas.

50 measures apparently in the tube.
 25 azote left, after firing and washing.

The volumists would explain it thus:—

20 ammoniacal gas = 10 azote + 30 hydrogen.
 30 nitrous gas = 15 azote + 15 oxygen.

Therefore 25 azote produced.

But an atomist might with equal plausibility reconcile the facts to his system. Thus

20 am. gas (23 real) = 12 azote + 30 hyd. (allowing 180 per cent.)
 30 nitrous gas = 13½ + 16½ oxygen.

25½
 Subtract ½ azote + 1½ oxygen = nitric acid.

Therefore 25 azote produced.

The 30 hydrogen take 15 oxygen, and the ½ azote takes 1½ oxygen; so that there ought to be just 25 pure azote left when the acid is engaged by water or mercury.

After these observations it may suffice to give the particulars of three experiments, exhibiting nearly the extreme cases and the mean:—

1. 41 nitrous gas, 94 per cent. = 38½ real + 2½ azote.
 53 ammonia containing 3½ air = 7 oxy. + 2·8 azote.

94
 85 fired.
 75 washed, 26 hydrogen, 49 azote.

Here 7 oxygen would take 1½ nitrous to form nitrous acid before the explosion, and we must count on 37 nitrous only. The explanation I should give would be this:—

37 nit. gas = 17 azote + 20 oxygen.
 52 am. gas = 27 azote + 66 hyd. = 40 (for oxy.) + 26 residue.

44 azote + 5 extra = 49 residue.

This result does not seem to admit of any explanation on the other system,

2. 72 nitrous gas, 92½ per cent. = 66½ real + 5½ azote.
 53 ammonia, 99 per cent. = 52½ + ½ azote.

125

67.5 fired.

63 washed, 1 or 2 hydrogen, found by adding a little hydrogen, and exploding with oxygen.

Here we have 2 hydrogen and 6 azote to subtract, and there will remain 55 azote generated from the nitrous gas and the ammonia. Estimating the effective nitrous gas at 66, the following explanation may be given:—

$$\begin{array}{r} 66 \text{ nit. gas} = 30 \text{ azote} + 36 \text{ oxygen.} \\ 51 \text{ am. gas} = 26\frac{1}{2} + 66 \text{ hyd. (= 64 [= 32 oxy.] + 2).} \\ \hline 56\frac{1}{2} \\ 1\frac{1}{2} + 4 \text{ oxygen} = \text{nitrous acid.} \end{array}$$

The other hypothesis would also afford an easy solution; but we must admit that no nitrous acid is formed, and that part of the ammonia escapes combustion. Thus

$$\begin{array}{r} 66 \text{ nitrous gas} = 33 \text{ azote} + 33 \text{ oxygen.} \\ 45 \text{ am. gas} = 22\frac{1}{2} + 67\frac{1}{2} \text{ hydrogen.} \\ \hline 55\frac{1}{2} \text{ azote, and } 1\frac{1}{2} \text{ surplus hydrogen.} \end{array}$$

3. 78 nitrous gas, 92 per cent. = 72 real + 6 azote.
 28 ammoniacal gas, 99 per cent.

106

60½ fired, muddy.

60½ washed, 8½ oxygen.

Here we find 46 azote generated from the nitrous gas and ammonia, which may be explained thus:—

$$\begin{array}{r} 72 \text{ nitrous gas} = 33 \text{ azote} + 39 \text{ oxygen.} \\ 31 \text{ ammo. gas} = 16\frac{1}{2} + 40 \text{ hydrogen.} \\ \hline 49\frac{1}{2} \\ 3\frac{1}{2} \text{ azote} + 10 \text{ oxygen} = \text{nitric acid.} \\ \hline 46 \end{array}$$

An explanation on the other system might be as under:—

$$\begin{array}{r} 72 \text{ nit. gas} = 26 \text{ azote} + 36 \text{ oxygen (= } 19\frac{1}{2} + 8 + 8\frac{1}{2}\text{).} \\ 26 \text{ am. gas} = 13 + 39 \text{ hydrogen (} 19\frac{1}{2} \text{ oxygen).} \\ \hline 49 \\ 3 + 8 \text{ oxygen} = \text{nitric acid.} \\ \hline 46 \text{ azote.} \end{array}$$

It is clear, therefore, that experiments with mixtures of nitrous gas and ammonia should be made with an excess of ammonia, if they are intended to decide between the two theories.

ARTICLE III.

A General Formula for the Analysis of Mineral Waters.

By John Murray, M.D. F.R.S.E.*

THE analysis of mineral waters has always been considered as a difficult operation. Numerous methods are employed to discover their ingredients, and estimate their quantities, many of which are liable to errors. This diversity of method itself is a source of discordant results; and to those not familiar with such researches, it presents the difficulty often of determining what process is best adapted to discover a particular composition. Hence the advantage of a general formula, if this could be given, applicable to the analysis of all waters. The views which have been stated in the papers connected with this subject, which I have had the honour of submitting to the Society, have suggested a method which appears to me to admit of very general application, and to be simple, not difficult of execution, nor liable to any sources of error but what may be easily obviated. The principles on which this method is founded, and the details of the process itself, form the subject of the following observations.

Two methods of analysis have been employed for discovering the composition of mineral waters—what may be called the *direct method*, in which, by evaporation, aided by the subsequent application of solvents, or sometimes by precipitants, certain compound salts are obtained; and what may be called the *indirect method*, in which, by the use of re-agents, the principles of these salts, that is, the acids and bases of which they are formed, are discovered, and their quantities estimated, whence the particular salts, and their proportions, may be inferred.

Chemists have always considered the former of these methods as affording the most certain and essential information: they have not neglected the latter; but they have usually employed it as subordinate to the other. The salts procured by evaporation have been uniformly considered as the real ingredients, and nothing more was required, therefore, it was imagined, for the accuracy of the analysis, than the obtaining them pure, and estimating their quantities with precision. On the contrary, in obtaining the elements merely, no information, it was believed, was gained with regard to the real composition; for it still remained to be determined in what mode they were combined; and this, it was supposed, could be inferred

* From the Transactions of the Royal Society of Edinburgh, vol. viii. p. 350.

only from the compounds actually obtained. This method, therefore, when employed with a view to estimate quantities, has been had recourse to only to obviate particular difficulties attending the execution of the other, or to give greater accuracy to the proportions, or, at farthest, when the composition is very simple, consisting chiefly of one genus of salts.

Another circumstance contributed to lead to a preference of the direct mode of analysis—the uncertainty attending the determination of the proportions of the elements of compound salts. This uncertainty was such, that, even from the most exact determination of the absolute quantities of the acids and bases existing in a mineral water, it would have been difficult, or nearly impracticable, to assign the precise composition and the real proportions of the compound salts; and hence the necessity of employing the direct method of obtaining them.

The present state of the science leads to other views.

If the conclusion were just, that the salts obtained by evaporation, or any analogous process from a mineral water, are its real ingredients, no doubt could remain of the superiority of the direct method of analysis, and even of the absolute necessity of employing it. But no illustrations, I believe, are required to prove that this conclusion is not necessarily true. The concentration by the evaporation must in many cases change the state of combination, and the salts obtained are hence frequently products of the operation, not original ingredients. Whether they are so or not, and what the real composition is, are to be determined on other grounds than on their being actually obtained; and no more information is gained, therefore, with regard to that composition, by their being procured, than by their elements being discovered; for when these are known, and their quantities are determined, we can, according to the principle from which the actual modes of combination are inferred, whatever this may be, assign with equal facility the quantities of the binary compounds they form.

The accuracy with which the proportions of the constituent principles of the greater number of the compound salts are now determined enables us also to do this with as much precision as by obtaining the compounds themselves; and if any error should exist in the estimation of these proportions, the prosecution of these researches could not fail soon to discover it.

The mode of determining the composition of a mineral water, by discovering the acids and bases which it contains, admits, in general, of greater facility of execution, and more accuracy, than the mode of determining it by obtaining insulated the compound salts. Nothing is more difficult than to effect the entire separation of salts by crystallization, aided even by the usual methods of the action of alcohol, either as a solvent or a precipitant, or by the action of water as a solvent at different temperatures; in many cases it cannot be completely attained, and the analysis must be deficient in accuracy. No such difficulty is attached to the other

method. The principles being discovered, and their quantities estimated in general from their precipitation in insoluble compounds, their entire separation is easily effected. Nothing is easier, for example, than to estimate the total quantity of sulphuric acid by precipitation by barytes, or of lime by precipitation by oxalic acid. And this method has one peculiar advantage with regard to accuracy, that if any error is committed in the estimation of any of the principles, it is discovered in the subsequent step of inferring the binary combinations, since, if all the elements do not bear that due proportion to each other which is necessary to produce the state of neutralization, the excess or deficiency becomes apparent, and of course the error is detected. The indirect method, then, has every advantage over the other, both in accuracy and facility of execution.

Another advantage is derived from these views, if they are just, that of precluding the discussion of questions which otherwise fall to be considered, and which must often be of difficult determination, if they are even capable of being determined. From the state of combination being liable to be influenced by evaporation, or any other analytic operation by which the salts existing in a mineral water are attempted to be procured, discordant results will often be obtained, according to the methods employed; the proportions at least will be different, and sometimes even products will be found by one method which are not by another. In a water which is of complicated composition, this will more peculiarly be the case. The Cheltenham waters, for example, have, in different analyses, afforded results considerably different; and, on the supposition of the salts procured being the real ingredients, this diversity must be ascribed to inaccuracy, and ample room for discussion with regard to this is introduced. In like manner, it has often been a subject of controversy whether sea-water contains sulphate of soda with sulphate of magnesia. All such discussions, however, are superfluous. The salts procured are not necessarily the real ingredients, but in part, at least, are products of the operation, liable, therefore, to be obtained or not, or to be obtained in different proportions, according to the method employed. And all that can be done with precision is to estimate the elements, and then to exhibit their binary combinations according to whatever may be the most probable view of the real composition.

The process I have to state, conformable to these views, is essentially the same as that which I employed in the analysis of sea-water in a preceding memoir; and it was the consideration of the advantages belonging to it that has led me to propose it, with the necessary modifications, as one of general application.

Mineral waters have been arranged under the four classes of carbonated, sulphureous, chalybeate, and saline. But all of them are either saline, or may be reduced under this division. From waters of the first class, the carbonic acid which is in excess is expelled by heat, and its quantity is estimated. Sulphureted hydrogen is in

like manner expelled or decomposed; and iron may be detected by its particular tests, and removed by appropriate methods. In all these cases the water remains, with any saline impregnation which it has, and of course is essentially the same in the subsequent steps of its analysis as a water purely saline; the precaution only being observed of these principles being removed, and of no new ingredient being introduced by the methods employed.

The salts usually contained in mineral waters are carbonates, sulphates, and muriates, of lime, of magnesia, and of soda. In proceeding to the analysis, a general knowledge is of course first to be gained of the probable composition by the application of the usual tests; the presence of sulphuric and carbonic acids being detected by nitrate of barytes, of muriatic acid by nitrate of silver, of lime by oxalic acid, of magnesia by lime-water or ammonia, and of any alkaline neutral salt by evaporation. It will also be of advantage to obtain the products of evaporation, and ascertain their quantities, without any minute attention to precision, the object being merely, by these previous steps, to facilitate the more accurate analysis.

Supposing this to be done, and supposing the composition of the water to be of the most complicated kind, that is, that by the indications from tests, or by evaporation, it has afforded carbonates, sulphates, and muriates of lime, magnesia, and soda, the following is the general process to be followed to ascertain the ingredients, and their proportions.

Reduce the water by evaporation, as far as can be done without occasioning any sensible precipitation or crystallization; this, by the concentration, rendering the operation of the re-agents to be employed more certain and complete. It also removes any free carbonic acid.

Add to the water thus concentrated a saturated solution of muriate of barytes, as long as any precipitation is produced, taking care to avoid adding an excess. By a previous experiment, let it be ascertained whether this precipitate effervesces or not with diluted muriatic acid, and whether it is entirely dissolved. If it is, the precipitate is of course carbonate of barytes, the weight of which, when it is dried, gives the quantity of carbonic acid; 100 grains containing 22 of acid. If it do not effervesce, it is sulphate of barytes, the weight of which, in like manner, gives the quantity of sulphuric acid; 100 grains, dried at a low red heat, containing 34 of acid. If it effervesce, and is partially dissolved, it consists both of carbonate and sulphate. To ascertain the proportions of these, let the precipitate be dried at a heat a little inferior to redness, and weighed; then submit it to the action of dilute muriatic acid; after this wash it with water, and dry it by a similar heat, its weight will give the quantity of sulphate, and the loss of weight that of carbonate of barytes.

By this operation the carbonic and sulphuric acids are entirely removed, and the whole salts in the water are converted into mu-

riates. It remains, therefore, first to discover and estimate the quantities of the bases present, and then, to complete the analysis, to find the quantity of muriatic acid originally contained.

Add to the clear liquor a saturated solution of oxalate of ammonia as long as any turbid appearance is produced. The lime will be thrown down in the state of oxalate. The precipitate being washed, may be dried; but as it cannot be exposed to a red heat without decomposition, it can scarcely be brought to any uniform state of dryness with sufficient accuracy to admit of the quantity of lime being estimated from its weight. It is, therefore, to be calcined with a low red heat, by which it is converted into carbonate of lime, 100 grains of which are equivalent to 56 of lime. But as a portion of carbonic acid may be expelled if the heat is raised too high, or a little water retained if it is not high enough; it is proper to convert it into sulphate, by adding sulphuric acid to a slight excess, and then exposing to a full red heat. The dry sulphate of lime will remain, 100 grains of which contain 41.5 of lime.*

The next step is to precipitate the magnesia. With regard to this there is some difficulty, particularly as connected with the design of the present formula. The principle on which it is founded is, first, to remove all the acids but the muriatic; and, secondly, to remove the bases, or otherwise estimate their quantities. The lime and the magnesia may be removed by precipitation; the soda cannot. The process, therefore, must be so conducted as to leave it at the end in the state of muriate of soda. Hence it is necessary either to remove any new product introduced in the previous steps of the analysis, or if any such remain, to be able to estimate its quantity with precision. In decomposing the muriate of lime by oxalate of ammonia, muriate of ammonia is substituted, which can be afterwards dissipated by heat. The object, therefore, is to decompose the muriate of magnesia, and remove the magnesia, either by some similar method, or, if not, by some other in which the muriate substituted can be accurately estimated; and to attain one or other of these conditions, gives rise to the difficulty to which I have alluded.

The decomposition of the magnesian salt by ammonia would have the former advantage, as the muriate of ammonia would be expelled at the end of the process by heat; but this decomposition, it is well known, is only partial. Subcarbonate of ammonia causes a more abundant precipitation of magnesia, but still its action is

* The only source of error to which this step of the analysis is liable, is that which will arise if more barytes has been used in the first operation than was necessary to precipitate the sulphuric and carbonic acids. It will be thrown down in the state of oxalate of barytes, and be converted into carbonate and sulphate, and thus give the apparent proportion of lime too large. This is obviated, of course, by taking care to avoid using an excess of barytes. To render the operation of the oxalate of ammonia as perfect as possible in precipitating the lime, the water should be considerably reduced by evaporation, taking care to avoid any separation of any of its ingredients.

likewise partial, a ternary soluble salt being formed after a certain quantity has been added. It seemed probable that this might be obviated by adding the subcarbonate of ammonia as long as it occasioned any precipitation, then evaporating the clear liquor to dryness, expelling the muriate of ammonia, and any excess of ammonia, by heat, redissolving, and again adding the subcarbonate of ammonia to decompose the remaining magnesian salt. Proceeding in this way, I found that a copious precipitation took place on the second addition, and even at the fourth a small quantity of precipitate was thrown down. But the decomposition, after all, was not perfect, for the quantity of magnesia obtained was not equal to what was procured by other methods.

Subcarbonate of soda or potash has been usually employed to precipitate magnesia from its saline combinations. The precipitation, however, is only partial, unless an excess of the precipitant be employed (and even then, perhaps, is not altogether complete); and as this excess cannot easily be estimated, it introduces a source of error in estimating the quantity of muriate of soda at the end of the operation, against which it is not easy to guard.

(To be continued.)

ARTICLE IV.

On the Salts composed of Sulphuric Acid and Peroxide of Iron.

By Thomas Thomson, M.D. F.R.S.

THE atomic theory has occupied the attention of chemists for so short a time, that we need not be surprised that several difficulties occur in it which it has not been possible hitherto to remove. One of these, which does not seem the least important, is the determination of the weight of an atom of those metals which combine with two doses of oxygen, having to each other the ratio of two to three. This is the case with sodium, iron, nickel, cobalt, and several others. At first sight the determination appears easy. The oxides of sodium are composed as follows:—

1 protoxide or soda of	6 sodium	+	2 oxygen
2 peroxide	6	+	3

It is natural to conclude that the weight of an atom of sodium is 6, and that soda is a compound of 1 atom sodium + 2 atoms oxygen; and the peroxide of 1 atom sodium + 3 atoms oxygen. This accordingly is the opinion of Dalton and Berzelius. It was the opinion which I myself adopted in the tables that I gave of the weights of the atoms of bodies in the second and third volumes of the *Annals of Philosophy*.

But sulphate of soda (abstracting the water of crystallization) is

composed of 5 sulphuric acid + 4 soda, or of 10 sulphuric acid + 8 soda. Now the weight of an atom of sulphuric acid being 5, it is obvious that if we consider 8 as the weight of an atom of soda, sulphate of soda must be a compound of 2 atoms sulphuric acid + 1 atom soda. In like manner, in all the neutral salts of soda one atom of the alkali will be united with two atoms of acid. The salts of potash, ammonia, lime, barytes, strontian, and magnesia, when neutral, are all compounds of 1 atom acid + 1 atom base. It would, therefore, be singular if the salts of soda should constitute an exception to what appears to be a general law, namely, that neutral salts are compounds of one atom acid and one atom base.

When we apply Richter's law to the double decomposition of salts of soda by other neutral salts; namely, that the new salts formed are as neutral as the original salts, and consequently that there is no unsaturated residue either of acid or base, we immediately find that an atom of soda cannot be represented by 8, but that its true weight must be 4. To give an example: Nitrate of barytes, when mixed with sulphate of soda in the requisite proportion, occasions a total decomposition of both salts: sulphate of barytes and nitrate of soda are formed both neutral, and there is no surplus either of barytes or soda, or of either of the acids. Now nitrate of barytes is composed of

Nitric acid	6.75	or 1 atom
Barytes	9.75	1

Sulphate of barytes of

Sulphuric acid	5.00	or 1 atom
Barytes	9.75	1

Hence it is obvious that, in order to decompose 16.5 by weight of nitrate of barytes, we must employ a quantity of sulphate of soda containing only 5 or one atom of sulphuric acid; so that its constituents must be—

Sulphuric acid	5
Soda	4

It is plain that if we mix together 9 parts by weight of sulphate of soda (supposing the water removed) and 16.5 parts of nitrate of barytes, we shall form two neutral salts, sulphate of barytes, and nitrate of soda. The weight of the first will be—

Sulphuric acid	5
Barytes	9.75
	<hr/>
	14.75

and the weight of the second—

Nitric acid	6.75
Soda	4
	<hr/>
	10.75

In this decomposition there was present an atom of sulphuric acid, of nitric acid, and of barytes. It is plain that there must have been present, likewise, an atom of soda. But if so, an atom of soda must weigh 4; consequently an atom of sodium must weigh 3, and soda must be a compound of 1 atom sodium + 1 atom oxygen. This removes the anomaly respecting the salts of soda; because, if the weight of an atom of soda be 4, then all the neutral salts are composed of 1 atom acid + 1 atom soda.

But as the oxygen in soda is to the oxygen in the peroxide of sodium as 2 to 3, it is obvious that if soda be a compound of 1 atom sodium + 1 atom oxygen, then the peroxide of sodium must be a compound of 1 atom sodium + $1\frac{1}{2}$ atom oxygen. Now this is as great a difficulty as the one which we have got rid of; for from the very nature of an atom it is impossible to admit its divisibility.

On considering the subject with attention, it occurred to me that the difficulty would disappear if we considered the peroxide of sodium as a compound of two atoms sodium and 3 atoms oxygen. On that supposition its weight would be represented by the number 9. As it is difficult to obtain the peroxide of sodium pure in any quantity, and as we are not acquainted with any compounds of which it constitutes a part, it was not possible to put this supposition, as far as sodium is concerned, to the test of experiment; but iron, as far as its combinations with oxygen are concerned, is precisely in the same circumstances as sodium. It unites with two proportions of oxygen; and the oxygen in the protoxide is to that in the peroxide as 2 to 3. If we decompose proto-sulphate of iron by nitrate of barytes, we shall find that the weight of an atom of protoxide of iron must be represented by the number 4.5, and that the weight of an atom of iron is 3.5. If we suppose peroxide of iron a compound of two atoms iron and three atoms oxygen, to get rid of the anomaly of the half atom, it is plain that the weight of an atom of peroxide of iron must be 10. Now as peroxide of iron is capable of uniting with acids, and forming salts, we can put the supposition that its weight is 10 to the test of experiment.

I prepared a quantity of very pure crystals of proto-sulphate of iron, reduced them to powder, and left them in that state upon blotting paper in a dry room till they were quite dry. 100 grains of the powder were then dissolved in distilled water acidulated with nitric acid, and the solution evaporated to dryness, and the dry mass was mixed with water, and evaporated to dryness two or three times, in order to get rid of the whole of the nitric acid which remained undecomposed; but care was taken not to raise the heat so high as to endanger the dissipation of any of the sulphuric acid. The dry mass had a red colour, and an intensely astringent taste. It obviously contained the whole of the sulphuric acid combined with the protoxide of iron, now converted into peroxide by the agency of the nitric acid. I poured a quantity of water on it. A

considerable portion dissolved, constituting a red liquid, having an intensely astringent taste. There remained at the same time undissolved a tasteless powder, having an orange colour, and not altered by exposure to the atmosphere. The red liquid, being evaporated to dryness, and the residue left in the open air, speedily deliquesced into a red astringent liquid.

Now 100 grains of crystallized proto-sulphate of iron are composed of

Anhydrous salt	55
Water	45
	<hr/>
	100

The 55 grains of anhydrous salt are composed of

Sulphuric acid	28·9473
Protoxide of iron	26·0527
	<hr/>
	55·0000

The protoxide of iron being converted into peroxide, its weight would become equal to that of the sulphuric acid; so that the constituents of the two compounds obtained, taken together, must have been

Sulphuric acid	28·9473
Peroxide of iron	28·9473
	<hr/>
	57·8946

For the sake of greater perspicuity, let us suppose the weight of these two constituents to be 100, or 50 sulphuric acid + 50 peroxide.

I found the weight of the insoluble powder exactly one-third of that of the soluble salt; so that the weight of

The insoluble powder was	25
The soluble salt	75
	<hr/>
	100

I dissolved the insoluble powder in muriatic acid, precipitated the sulphuric acid by means of muriate of barytes, and the peroxide of iron by means of ammonia. The weight of these constituents was as follows:—

Sulphuric acid	5
Peroxide of iron	20
	<hr/>
	25

The soluble salt, being treated in the same way, yielded the following constituents:—

Sulphuric acid	45	or	15
Peroxide of iron	30		10
	<hr/>		<hr/>
	75		25

We perceive at once that the insoluble salt contained twice the weight of iron, and only one-third the weight of sulphuric acid, that existed in the soluble salt. If the weight of an atom of peroxide of iron be 10, then the insoluble powder will be a compound of 1 atom acid + 2 atoms peroxide, and the soluble salt a compound of 3 atoms acid + 1 atom peroxide. These analyses, I conceive, demonstrate that the weight of an atom of peroxide of iron is 10. Hence I think we may conclude that all those oxides which are to the oxides immediately below them in the proportion of their oxygen as 3 to 2 are compounds of 2 atoms base + 3 atoms oxygen. This supposition will remove a very considerable difficulty, hitherto perplexing the atomic theory.

The metals to which this law applies are,

- | | |
|------------|------------|
| 1. Sodium, | 4. Cobalt, |
| 2. Nickel, | 5. Cerium. |
| 3. Iron, | |

The weight of an atom of each, according to the most accurate experiments hitherto made, is as follows:—

Sodium	3
Nickel	3.375
Iron	3.5
Cobalt	3.625
Cerium	5.75

The protoxides of these metals, being compounds of 1 atom metal + 1 atom oxygen, must be of the following weights:—

Soda	4
Protoxide of nickel	4.375
———— iron	4.5
———— cobalt	4.625
———— cerium	6.75

The peroxides, being compounds of 2 atoms metal + 3 atoms oxygen, must weigh as follows:—

Peroxide of sodium	9
———— nickel	9.75
———— iron	10
———— cobalt	10.25
———— cerium	14.5

Besides the two persulphates of iron analyzed in this paper, there is a third persulphate, which may be formed by digesting peroxide of iron in concentrated sulphuric acid. A white paste is formed, which I consider as a hydrated persulphate. But there is no means of subjecting it to analysis, because, when water is poured upon it, two salts are formed, one of which dissolves in the water, and the other remains in the state of an insoluble powder. I think it not improbable that two other compounds of sulphuric acid and peroxide of iron exist; namely, one consisting of 1 atom acid + 1

atom peroxide united together, and one consisting of 2 atoms acid + 1 atom peroxide. The second of these I think I have made; but I have not been able to obtain satisfactory evidence of the existence of the other. The persulphates of iron, then, are probably four in number:—

- | | | |
|--|---|-----|
| 1. Subbipersulphate, composed of 1 atom acid + 2 atoms peroxide. | | |
| 2. Persulphate | 1 | + 1 |
| 3. Bipersulphate | 2 | + 1 |
| 4. Tripersulphate | 3 | + 1 |

In converting proto-sulphate of iron into persulphate by means of nitric acid, a portion of the sulphuric acid is apt to make its escape. Considerable attention, therefore, is necessary in order to obtain the above results. I have, however, repeated the experiment several times, and have no doubt of the accuracy of the proportions which I have given.

ARTICLE V.

Memoir on the Mode of exploring the Interior of Africa. By H. Edmonston, Esq. Surgeon, Newcastle-upon-Tyne.*

The different expeditions set on foot of late years for exploring the interior of Africa are such as do honour to this age and country, and leave us room only for regret that the success has been so little commensurate to the exertions so repeatedly made.

Yet if the causes of failure be carefully and candidly examined, there will be reason to suspect that some of them are not fairly ascribable to the nature of the enterprize in itself; and at all events there are others which, with attention, might have been prevented or avoided.

These and similar reflections have often occurred to my mind, more especially since I have read in the periodical journals and newspapers of the outfit and sailing of the two expeditions destined to penetrate into Africa by the rivers Gambia and Congo. And, Sir, as you were among the first to give to the world the journal of Isaaco respecting the probable fate of Mungo Park, and as you appear to take a lively interest in the subject, I hope you will not consider the following observations altogether misplaced in the *Annals of Philosophy*.

Some may think that little loss would have been sustained had I kept these remarks to myself; and in all probability I should have

* This memoir was originally written not very long after the two expeditions under Major Peddie and Captain Tuckey sailed for Africa. But as the speculations which it contains have not been materially affected by the result of those expeditions, it is inserted here almost without alteration.

done so, seeing that the voyagers have already gone on their destination, and consequently that nothing in my power to advance as mere matter of opinion can have any effect in counteracting what, I fear, we shall one day have reason to pronounce an ill-judged and most imprudent measure. But I observe in the last number of the Quarterly Review an intimation that the son of Mungo Park, animated by the filial enthusiasm of Telemachus, waits but for "the coming on of time," to go in quest of his father, whom his hopes represent to him as still alive. The idea of this, I own, affects me powerfully; and it is chiefly in the view that they may operate as cautions to him that I have determined on submitting my thoughts to the public. I doubt not that those who are, or shall be, his advisers, are thoroughly aware of all the perils of such an exploit. Still the suggestions of even a common observer are sometimes worth attending to.

Perhaps some apology is required of me for expressing myself with such freedom as I shall have occasion to do, on account of the appearance which it may have of unnecessarily wounding the feelings of those left behind. But I cannot persuade myself to believe any thing else, than that the relatives and friends of the intrepid voyagers have made up their minds to the worst that can happen. It is impossible to meditate for a moment on the character of the enterprize, or to peruse attentively the last journal of Park, without being fearfully impressed with the dangers to which all are exposed who attempt to follow his footsteps.

For the sake of perspicuity, I shall divide my remarks into three parts.

The *first* will comprehend those objections which are more particularly applicable to the manner in which Park's last expedition was conducted.

The *second*, those objections which apply with force to all military expeditions whatever.

The *third* will contain some suggestions respecting what appears to be the most practicable and feasible method of exploring the continent of Africa.

First, then, as to the management of Park's last expedition.

Where there is so much to call forth our sympathy, sorrow, and admiration, it is an ungracious duty to point out any grounds of censure; But truth, and the safety of future adventurers, require that, if they must, like Park, fall victims to their zeal and spirit, they may at least avoid participating in some of his errors.

The very first, and perhaps the most material circumstance, that strikes us is the complete miscalculation with respect to the difficulties to be met with, and the means by which they were to be obviated. Park seems to have laboured under the unlucky misconception that a cottle composed of 50 armed persons, their guides, baggage, beasts of burthen, and provender, could move as rapidly through the country as he had done on a former occasion with only

his guide and a negro boy. In consequence of unexpected difficulties, many of them such as his utmost endeavours were inadequate to surmount, the unhealthy season came upon him when he had but half finished his land journey previous to his embarkation on the Niger. Rather than wait at Pisania till the unfavourable season was completely over, when he might have set out with the earliest return of dry weather, he resolved to attempt what was barely possible, even supposing every thing to have gone on prosperously. To this unfortunate resolution, by which at the very outset the whole result was put to the utmost hazard, are perhaps to be attributed all, or many of the disasters which befel the expedition previous to his arrival at Bambakoo, on the Niger. This is the more to be regretted, that it could not be said to be necessary. Government and the country placed such entire reliance on his judgment and ardour, that a few weeks or months would have made no difference. He might have taken his own time. How precious that time was, and how usefully it might have been spent in making prudential arrangements, it is now as vain as it is painful to contemplate. But, unhappily, he appeared to have been hurried away by an enthusiasm little short of infatuation, and to be buoyed up with expectations which his own experience should have told him were altogether visionary, and which no circumstances could at that time justify. So fully was he under the influence of this impression, that we find him, previous to his setting off, writing to his wife and friends in a strain of certainty, as if the term of the journey could be anticipated with all the exactness of an East India voyage.

One very bad effect which the unseasonable period of commencing his travels produced was, that it compelled him, after he began to perceive the time passing off, to post through the country with a degree of speed which must of itself have been sufficient to kindle suspicion in the minds of the Moors, and prevented him from paying that attention to his sick which their situation required. We find Isaaco, on the contrary, who had on every account less occasion to halt, tarrying some days with a chief, on purpose to convince him that he had no sinister object in view, by which means he at once secured his confidence.

Park had likewise too lofty notions of the superiority of his fire-arms over the numbers and weapons of the natives. Though expert marksmen, the inhabitants of the interior are far from being ignorant of the use of gunpowder.

One very glaring mistake into which he allowed himself to fall was not conforming to the manner of the country in the article of dress. Indeed, it has always been to me a matter of extreme surprise what little attention has generally been paid by British travellers to points which are in appearance trivial, but in reality are most important. From some mistaken conceptions or other, they for the most part deem it quite beneath their consideration to accommodate themselves to the habits and institutions of other people, particularly of semibarbarous tribes, amongst whom an opposite

conduct is sometimes of the greatest service. With polished people, the necessity for this adaptation is less; but amongst half civilized tribes, a conformity to prejudices and peculiarities is indispensable, if the traveller be desirous of avoiding inconveniences and hardships innumerable.

In no respect is this disregard more generally conspicuous, or the observance more necessary, than in the article of dress. One can scarcely restrain a smile when one finds such a man as Park in his first expedition higgling with Mansong, King of Bambarra, about his best *coat*, probably made by some fashionable London tailor! After landing in Africa, or at least after parting with Dr. Laidley at Pisania, what had he to do with clothes cut after the Bond-street fashion? Had Mansong stripped him of his European dress, and given him the African habit in exchange, he had rendered him the greatest possible service, and probably might have secured by that means the success of the enterprize.

Foreign travellers, and particularly the French, appear to understand these matters better than we do. Pagès not only adopted the dress, and complied as far as possible with the customs of those among whom he journied, but he was at pains to prepare himself beforehand, by voluntarily subjecting his constitution to such hardships and privations as he was likely to encounter, by which means he obtained unusual facilities in the prosecution of his researches.

Volney assumed the turban, and other parts of the Turkish attire. Sonnini takes frequent occasion to mention the insults and dangers to which he was exposed in Egypt, when the least remissness in this respect was practised. Even our countryman Bruce felt the necessity and advantage of attending to these particulars: "As he had in the Barbary States seldom quitted the Arab dress, he retained it on landing in Egypt, in order to mislead the inquisitive spirit of the populace, who mistook him under the disguise for a Mugrebin, or Barbary Arab." (Preface to Bruce's Travels.)

It is easy to conceive that an individual possessing a knowledge of the language, and dressed in the costume of the country, might frequently pass through unnoticed, while another, habited in such a manner as to engage the utmost attention of the natives, would be exposed to all the vexations and delays which the satisfying of ignorant and suspicious curiosity must continually produce. Of this we have repeated instances in the histories of all travellers, and of Park himself, both in his first and second journey; yet did he neglect to profit by what he must have observed, and equipped himself, and probably all his retinue, in the British uniform.

One decided disadvantage attending nonconformity in dress is, that it holds out to the natives an irresistible allurements to theft. It is almost unnecessary to notice the great value which European articles of dress bear in Africa, and the desire which barbarians universally have for particular things, not because they are useful, but merely because they are strange. Accordingly, many of the *depredations* committed on Park had his clothing for their chief

object: and such were the attractions of even the buttons of his waistcoat, that he often had recourse to them as valuable media of exchange for food, lodging, and other considerations of the last importance.

Another unfavourable circumstance, not however to be laid altogether to Park's charge, was the nature of the force under his command. It is remarkable that in different parts of his journal he speaks of *Old James*, and *Old Rowe*, and of one Macmillan, who had been *thirty-one years* a soldier, much addicted to the bottle, and so on. This shows but too clearly the very unsuitable materials from which he had to make his selection.

The very incident of his hoisting the British flag when he embarked at Sansanding, though to all appearance amusing, and of little moment, I cannot help regarding as a fatally injudicious measure. An object so singularly strange, along with the very unusual *rig* of the canoe, the *joliba* being a *schooner*, must have powerfully attracted the notice of the natives on both sides of the river, all the way as he went down, many of whom he must have offended irreconcilably by omitting to pay them their customary *lues*. Had it not been for these circumstances, it is not at all improbable that his canoe might have passed a considerable extent of the Niger unobserved, and consequently unmolested. Gliding along with the wind and tide at the rate of more than six miles an hour, he might have even outsped rumour itself, and been the first to announce his own arrival at the different places.

It would seem, likewise, from the testimony of Amadou Fatouma, that, after passing the eastern frontier of Bambarra, either from the hostility of the country, from his impatience to advance, or probably from desperation, occasioned by the loss of almost all his companions, he ceased to employ those arts of conciliation which he knew so well how to practise, and which had hitherto carried him through so prosperously, but made use of that resistance when his company had dwindled to five or six individuals, which he had never resorted to when guarded by 50 healthy soldiers.

There remains one defect from which he cannot be so easily excused, and that is his imperfect proficiency in the African Arabic.

Such are some of the principal grounds of objection that may, I should hope, without any reproach to the memory of the illustrious and lamented Park, be urged against the manner in which his last mission was conducted. Arising out of the events which occurred during both his journeys, as well as out of the general subject, and the histories of other writers, are those objections which I now purpose to offer against military expeditions of every description.

Of all the schemes hitherto projected, that of *forcing* a passage into the centre of Africa ever appeared to me amongst the wildest and most impracticable. That a person of Park's sagacity should have originally suggested such a proposal; that the African Association should for a moment have entertained it; but, above all, that the

Government should have sanctioned it, seems altogether unaccountable.

It was, therefore, devoutly to have been hoped and expected that the disastrous termination of Park's last journey had for ever decided the opinion of those in power against any similar expedition for the future. In this belief I had earnestly indulged, even when it was made known that two separate missions had taken their departure for Africa; for I was at pains to persuade myself that they were to consist of the officers themselves, and perhaps their servants: nor was I undeceived in this particular till I saw it announced in the newspapers that recruits from the Guards had actually sailed to reinforce the detachments already in Africa.

Though the voice of an individual is not likely to induce the higher powers to retrace the steps that have been already taken, it is the duty of every one to offer his sentiments when his intention in so doing is avowedly good; and, Sir, if they be held worthy of publicity by those who, like yourself, are the organs of information to the world, they may prove the means of preventing similar hazards and losses from being hereafter incurred.

In the present instance I feel the more strongly disposed to adopt this course, because the Editor of Park's last Journal argues strenuously for a military expedition, and deems himself countenanced and justified by the high professional authority of Major General Gordon.

The radical objection to every plan of this sort would seem to be the offensive and hostile appearance which it must assume in the eyes of any people, be they savage or civilized. What can be more outrageous to a people, or more inconsistent in itself, than for a band of armed men to land in a country, and to insist on marching from one extremity of it to the other, professing all the while the most friendly intention, yet threatening to make their way good by force, if interrupted or opposed?

That Park was able by dint of his admirable presence of mind to keep on good terms with the natives up to a certain date is truly astonishing. But it adds very little strength to the general argument. The distance from the coast to his place of embarkation on the Niger was comparatively short, and in some degree within reach of the coast. The same countries are daily traversed by slates and merchants, and the natives might readily enough imagine that vengeance would overtake them, should any injury be inflicted on the travellers. But such apprehensions would gradually lose their force as the distance from the coast became greatly increased, particularly after passing beyond the kingdoms of Tombuctoo and Housa, which appear to be the farthest limits even of Moorish travellers in the direction of the Senegal and the Gambia; and, arriving among tribes that had never seen a white man. In proof of this, if Amadou Fatouma is to be believed, and I admit that the reasons for giving implicit credit to his tale are not very convincing, it was not till Park had passed through those territories which may be considered

s bordering on, or immediately adjacent to, the coast, that he met with much serious annoyance.

If it be alleged, as Park himself alleges, that these tribes are in the habit of seeing large coffles continually passing by, and therefore would not deem it extraordinary to see a cavalcade of this kind; it may be replied that they are accustomed to see Moors, and people like themselves, engaged in peaceable occupations, and after paying the stated tribute. They never behold an armed force, composed of Christian white men, differing in dress, complexion, manners, and appearance, prepared, and sometimes threatening, to dispute their authority. Such an exhibition could not fail to awaken distrust and revenge in the minds of any people, and especially of a people who could not by any explanation be made to comprehend the object of such a visit. The states adjoining the coast might, from fear or interest, judge it expedient to let them pass; but those nations more distant, and who are not so dependant on trade for their advantages, would have no such inducements, and would in all probability view the matter according to the dictates of feeling and reason. If so, how could they help entertaining the most uneasy apprehensions, on seeing such a body entering their capitals, often too without so much as leave either asked or granted? In this point of view the explanation given by Park to the Ambassadors of Mansong, King of Bambarra, respecting the objects of his journey, seems to have been very incautious. He distinctly told them that he meant to endeavour to open channels of trade, by which the Moorish merchants might be undersold in the African markets. This might be agreeable enough intelligence to the negro population; but to the Moors it must have been the reverse, and must have exposed him to their utmost vengeance.

Observe with what jealousy the natives of some of the South Sea Islands have generally regarded all attempts to advance into the interior, and how dearly navigators have sometimes paid for their temerity, although they have had to explore small islands only, and under protection of the very muzzles of their own cannon. Can it be said that the inhabitants of the interior of Africa have in them less of mistrust and revenge, or indeed of those feelings and passions of our common nature which must on an occasion of this sort be immediately called into action?

But though the negroes, who are a mild and inoffensive race, should overlook the aggression, which, by the bye, is the most extravagant supposition that can be made, the implacable Moors, who in almost all the African states possess the predominant power, and who look upon all foreigners, and especially Christians, with an eye of suspicion and detestation, would not be so easily satisfied.

Park, in his first journal, says that Mansong, the negro King of Bambarra, did not consider himself safe from his turbulent Moorish subjects. If the King with all his power was not sufficiently protected, how could a handful of men protect themselves?

Should it be urged that caravans travel through Arabia and

Egypt, and over immense tracts in Africa, with the country around them hostile, it is answered that they traverse the deserts, or pass through small villages or groups of tents, scattered here and there, which can present no effectual opposition. The wandering Arabs are all divided into parties, and spread over a vast extent. They act in small bodies only, detached and independent. There are but few chances that the caravan will meet with more than one of them at a time, and for one it is generally an equal match. But granting this argument its utmost weight, the caravans, with all these advantages, are often attacked by the Arabs of the desert, plundered, and destroyed.

In Africa, in the direction of the Gambia and Niger, a caravan has to make its way through countries in many parts teeming with inhabitants, and through towns and cities, the residence of princes, and the seats of regal power.

A very mistaken idea prevails in respect to the power of the Africans to resist successfully an European force such as Park carried with him. There is nothing in Park's narrative to encourage such a notion. Though but little capable of regularly opposing in the field an European force of almost any magnitude, they are not without numerous sources of annoyance. According to Amadou Fatouma, the passage down the Niger was frequently interrupted by skirmishing, and even hard fighting, with the natives. In one place, Park informs us that "the satee, or Governor of these towns (in the kingdom of Neola) exacts customs to a great amount from all the coffes; and if refused, they join together and plunder them." In another place he says that "Mansa Kussan threatened to plunder them if they advanced without paying the customary tribute." And again we observe, no farther inland than Gadoo and Fouladoo, the natives "wearing a hostile appearance, having heard that the white men were to pass, that they were very sickly, and unable to make any resistance, or to defend the immense wealth in their possession."

One of the most serious obstacles to a military expedition is the almost insuperable difficulty of moving large bodies through countries unprovided with all accommodation or means of transport. To such an extent did this inconvenience operate, that Park, instead of being able to pursue the proper objects of the expedition, was obliged, even before his companions began to drop around him, to toil like a slave, carrying the baggage, driving the asses, and providing against the multiplying embarrassments which the cumbersome form alone of the expedition created.

Beasts of burthen, in any adequate numbers, seem to be unobtainable; and, even when procured, cannot be kept together, nor can provender be had in sufficient quantity, without incredible labour and expense.

Another inconvenience, of no small moment, attending the movement of a very large coffle of this kind, is the heavy tribute *thence payable* to the native princes. Isaaco's taxes were mere

trifles, compared with the liberal custom, or rather munificent presents every where lavishly dealt out by Park. This mistaken splendour, instead of satisfying, was, as we may naturally conceive, often the cause of rendering the demands more exorbitant. These fiscal charges, regularly rated, must be as punctually paid as at our own custom-houses; and they are always proportioned to the size and apparent value of the coffee.

There do not appear to be any traces of a road, and sometimes not even a pathway, in any part of the country; so that the proposal of Park's Editor of making the escort go by separate detachments, through a country having no roads, and the topography of which is utterly unknown, appears to be in the highest degree chimerical; and could be attended with no other effect, than that I am able to perceive, than that of multiplying the difficulties and dangers in a ratio even exceeding that of the number of detachments.

The soldiers composing a military expedition must of course *pluntee* their services. The principle of implicit obedience is thus to a certain degree weakened; and even were it otherwise, the means of enforcing rigid discipline are necessarily wanting. The objects of the enterprize cannot possibly be made plain to illiterate soldiers. Unlooked-for obstacles soon damp their ardour; the wish to avoid difficulties overcomes every other consideration; they either lag behind on pretence of sickness, or desert altogether. Of this there is an abundance of instances in Park's Journal; and it is probable it must ever be the case with soldiers, unless held down by the strong arm of power, or animated by the prospect of plunder, the sound of victory, or the hope of a much greater reward than the nature of the exploit will admit of their receiving.

Even the very circumstance of the corps from which the soldiers must be drafted is likely to defeat the object in view. If from one on a home station, and consequently admitting a choice of the finest men, the great probability is, that the climate to which they are uninured will prove fatal. If from a corps already at one of the forts on the coast of Africa, the age, constitutions, and character, of the men, are not such as to encourage sanguine hopes of success. They have in general been transferred to these remote stations either for misconduct or for crimes.

Park's Editor, on the authority of General Gordon, suggests the propriety of enlisting volunteers from the three companies of blacks serving in the Royal African Corps stationed on the coast. But it is worthy of remark that Park, in a letter to the Under Secretary of State for the Colonial Department, states that "no inducement could prevail on a single negro to accompany him." And though they should be induced, by what means could they be withheld from deserting to their friends as they happened to arrive in their native districts?

To have several leading men, as Park's Editor suggests, would lead to disagreement, and probably frustrate the design at some critical period of its progress.

Not to dwell with too much minuteness on difficulties, it may be mentioned that the very rank at which the officers who have gone on these missions have arrived gives indication of their unfitness in regard to age. To send men somewhat advanced in life is to send them to almost certain death. None but men in the fulness of youth and vigour ought to be appointed to so arduous an attempt.

In the memoir of Park's life prefixed to the Journal, we are informed that Major Rennel, himself a military character, and, from his profound knowledge of the subject, fully capable of estimating the force of every argument, was "so struck with the difficulties and dangers attending the expedition, that he earnestly dissuaded Park from engaging in so hazardous an enterprize." The opinion of such a judge, in himself a host, is of the highest importance; and had we been informed that persuasions so strongly urged, had, as is probable, a particular reference to the military character of the expedition, it would have effectually superseded what I have written; and thus your readers would have been spared the trouble of reading the long, and I am afraid tedious memoir. But this information, for some reason or other, has been omitted.

(To be continued.)

ARTICLE VI.

Observations on the Organ called Spur in the Ornithorhynchus Paradoxus. By M. H. de Blainville.*

DR. BLAINVILLE was induced to examine this organ in consequence of the curious fact stated by Sir John Jamieson which I inserted in a preceding number of the *Annals of Philosophy*. M. Geoffroy put under his disposal the two specimens of this animal in the collection of the Museum.

The organ called *spur* in the ornithorhynchus, because it has been compared with the instrument with which the tarsus of the males of gallinaceous fowls is armed, is placed very differently from that organ. It is situated on the external, and almost posterior side of the leg, almost in the middle of the space which separates the lower extremity of the two bones of the leg behind from the calcaneum, towards the astragalus, but without any articulation with these bones, really adhering only to the skin. Hence it appeared to me moveable, and capable of bending forwards and backwards. Its size, length, and sharpness, present, no doubt, sufficient variations. Authors agree that it is not found on females. Some have regarded it as a true spur, others as constituting a sixth toe or nail, but in reality without reason, as it constitutes an apparatus quite peculiar to this animal, and nothing similar to which is found in any other.

* Translated from the Bulletin des Sciences for May, 1817, p. 82.

Externally we see merely a sort of horny point, which is conical, more or less curved, adhering very firmly to the skin, which forms a protuberance at its base, and into which it penetrates pretty deeply. Towards its point, which is sometimes very obtuse, with a convex face, is a pretty large oval opening, continued towards the base in a simple furrow, and through which, in all probability, the point of the bone, of which we shall speak immediately, may issue.

At the bottom of the concave face of this horny covering is a fold, which is particularly visible at its opening at the edge of the cavity. The substance of which it is composed is as it were scaly, of a greyish-yellow colour, almost transparent, and very thin through the whole of its extent, and especially towards the point.

Within this sheath we find the really offensive organ, which probably does not fill the whole cavity, but which is surrounded by a whitish, mucous-looking substance. This organ has nearly the form of its sheath; but it is more awl-shaped and pointed, and formed of a substance which, in the state of desiccation in which I saw it, seems intermediate between bone and horn, but approaching more nearly to the former. It was pretty hard, compact, and yellowish; and its semitransparence rendered its interior canal somewhat visible. At its base there is a wrinkled protuberance, which serves to unite it the firmer to the skin. Its pointed extremity is terminated by a very fine oblique opening, which in a state of repose is horizontal with the opening of the sheath.

If we open this tooth-like substance with care, we find that it is hollow through its whole length; and that its walls, which are very thin at the base, become thicker as we approach the point. This cavity contains an apparatus, in all probability venomous, composed of a bag and of a canal. The bag has the shape of a flask, the bottom of which rests on the ligaments of the bones of the foot. In the state in which I saw it, it was yellow, very hard, and a little wrinkled; yet I could easily distinguish its cavity. Its outward extremity terminates insensibly in a narrow canal, twice as long as itself, which follows the course of the cavity in the bone, and terminates at the opening at its extremity.

I have not been able to determine positively if the organs which I have just described constitute the whole of the venomous apparatus, which I consider as probable, or if there be besides an organ of secretion, the liquid from which is deposited in the bag, in order to be transmitted through the canal, and inoculated by the bony spur, as is nearly the case in venomous serpents. This point can only be determined by examining the fresh animal, or at least the animal preserved in alcohol. Meanwhile it is certain that the ornithorhynchi, and probably the echidnea, have received from nature a venomous organ of defence, to make up for the feebleness of the rest of their organization, and particularly of their teeth. But it is very difficult to determine whether it be directed against their enemies, or against those animals which are destined for their prey; though I think the former opinion the most probable. It is obvious

that an apparatus so complex cannot be considered as a mere organ of luxury, or as an organ of combat between the males for the possession of the females, as is the case with the spurs of cocks; still less can its use be to retain the female during the act of copulation. Yet all authors are agreed to confine the organ called the *spur* to the males. Unfortunately, it has not been in my power to study this organ in the echidnea.

ARTICLE VII.

A Table showing the Quantity of Soda (either free or combined with Sulphur or Carbonic Acid) contained in the Specimen under Trial with Sulphuric Acid containing 10 per Cent. real Acid. If the Specimen under Trial consists of 100 Grains, the Table of course shows the per Centage of Alkali. By Charles Tennant, Esq. Glasgow.

(To Dr. Thomson.)

DEAR SIR,

Glasgow, June 7, 1817.

I BELIEVE I formerly mentioned to you that I had been long in the habit of trying specimens of the alkalis by a solution of sulphuric acid in water containing 10 per cent. real acid; I prefer it in this diluted state, as it enables me to determine the point of saturation with more precision. The acid may be either tinged with vegetable colouring matter, or test paper so stained may be used. I prefer the latter, stained with the colouring matter of radishes. I use the acid measured by a glass tube graduated into five grain divisions, which are as small as well can be made accurately. The individual grains are determined by drops.

This measure answers all the purposes of weighing, and saves much time. With a view to save time also in calculation, I use a table constructed so as to show in one view the per centage of alkali contained in any given specimen of mineral alkali weighing 100 grains, and not exceeding 24.48 per cent. alkali, which is the highest I have found in any specimen, even in the best of Barilla.

You will observe that I assume $\frac{1}{10}$ ths or .8 of a grain as the quantity of real soda equivalent to saturate one grain of real sulphuric acid, which is somewhat more than Dr. Wollaston's estimation, though less by a small fraction than Mr. Dalton's. It therefore forms a medium; and being a limited decimal, of easy calculation, I assume it in preference to the precise estimation of any publication. I inclose you a copy of the table, which you are at liberty to publish in your Journal if you consider it of any value.

I have found it extremely useful in our manufactory, and more easy in application than any mode of trying the various qualities of soda I have yet seen suggested on that subject.

I have also tables constructed on similar principles for ascertaining the value of the various descriptions of potash and volatile alkali,

tried with the same acid, and which you may have if you consider them worthy of notice.

I also keep a stock solution of soda containing five per cent. pure alkali, for the purpose of trying the strength of various acids, but have constructed no tables for them, having seldom occasion to use this test. They would, however, be equally easy of construction.

Believe me, dear Sir, ever faithfully yours,

CHARLES TENNANT.

Gr. Ac.	Grains Soda.	Gr. Ac.	Grains Soda.	Gr. Acid.	Grains Soda.	Gr. Acid.	Grains Soda.	Gr. Acid.	Grains Soda.	Gr. Acid.	Grains Soda.	Gr. Acid.	Grains Soda.
1	0.08	51	4.08	101	8.08	151	12.08	201	16.08	251	20.08		
2	0.16	52	4.16	102	8.16	152	12.16	202	16.16	252	20.16		
3	0.24	53	4.24	103	8.24	153	12.24	203	16.24	253	20.24		
4	0.32	54	4.32	104	8.32	154	12.32	204	16.32	254	20.32		
5	0.40	55	4.40	105	8.40	155	12.40	205	16.40	255	20.40		
6	0.48	56	4.48	106	8.48	156	12.48	206	16.48	256	20.48		
7	0.56	57	4.56	107	8.56	157	12.56	207	16.56	257	20.56		
8	0.64	58	4.64	108	8.64	158	12.64	208	16.64	258	20.64		
9	0.72	59	4.72	109	8.72	159	12.72	209	16.72	259	20.72		
10	0.80	60	4.80	110	8.80	160	12.80	210	16.80	260	20.80		
11	0.88	61	4.88	111	8.88	161	12.88	211	16.88	261	20.88		
12	0.96	62	4.96	112	8.96	162	12.96	212	16.96	262	20.96		
13	1.04	63	5.04	113	9.04	163	13.04	213	17.04	263	21.04		
14	1.12	64	5.12	114	9.12	164	13.12	214	17.12	264	21.12		
15	1.20	65	5.20	115	9.20	165	13.20	215	17.20	265	21.20		
16	1.28	66	5.28	116	9.28	166	13.28	216	17.28	266	21.28		
17	1.36	67	5.36	117	9.36	167	13.36	217	17.36	267	21.36		
18	1.44	68	5.44	118	9.44	168	13.44	218	17.44	268	21.44		
19	1.52	69	5.52	119	9.52	169	13.52	219	17.52	269	21.52		
20	1.60	70	5.60	120	9.60	170	13.60	220	17.60	270	21.60		
21	1.68	71	5.68	121	9.68	171	13.68	221	17.68	271	21.68		
22	1.76	72	5.76	122	9.76	172	13.76	222	17.76	272	21.76		
23	1.84	73	5.84	123	9.84	173	13.84	223	17.84	273	21.84		
24	1.92	74	5.92	124	9.92	174	13.92	224	17.92	274	21.92		
25	2.00	75	6.00	125	10.00	175	14.00	225	18.00	275	22.00		
26	2.08	76	6.08	126	10.08	176	14.08	226	18.08	276	22.08		
27	2.16	77	6.16	127	10.16	177	14.16	227	18.16	277	22.16		
28	2.24	78	6.24	128	10.24	178	14.24	228	18.24	278	22.24		
29	2.32	79	6.32	129	10.32	179	14.32	229	18.32	279	22.32		
30	2.40	80	6.40	130	10.40	180	14.40	230	18.40	280	22.40		
31	2.48	81	6.48	131	10.48	181	14.48	231	18.48	281	22.48		
32	2.56	82	6.56	132	10.56	182	14.56	232	18.56	282	22.56		
33	2.64	83	6.64	133	10.64	183	14.64	233	18.64	283	22.64		
34	2.72	84	6.72	134	10.72	184	14.72	234	18.72	284	22.72		
35	2.80	85	6.80	135	10.80	185	14.80	235	18.80	285	22.80		
36	2.88	86	6.88	136	10.88	186	14.88	236	18.88	286	22.88		
37	2.96	87	6.96	137	10.96	187	14.96	237	18.96	287	22.96		
38	3.04	88	7.04	138	11.04	188	15.04	238	19.04	188	23.04		
39	3.12	89	7.12	139	11.12	189	15.12	239	19.12	189	23.12		
40	3.20	90	7.20	140	11.20	190	15.20	240	19.20	190	23.20		
41	3.28	91	7.28	141	11.28	191	15.28	241	19.28	291	23.28		
42	3.36	92	7.36	142	11.36	192	15.36	242	19.36	292	23.36		
43	3.44	93	7.44	143	11.44	193	15.44	243	19.44	293	23.44		
44	3.52	94	7.52	144	11.52	194	15.52	244	19.52	294	23.52		
45	3.60	95	7.60	145	11.60	195	15.60	245	19.60	295	23.60		
46	3.68	96	7.68	146	11.68	196	15.68	246	19.68	296	23.68		
47	3.76	97	7.76	147	11.76	197	15.76	247	19.76	297	23.76		
48	3.84	98	7.84	148	11.84	198	15.84	248	19.84	298	23.84		
49	3.92	99	7.92	149	11.92	199	15.92	249	19.92	299	23.92		
50	4.00	100	8.00	150	12.00	200	16.00	250	20.00	300	24.00		

ARTICLE VIII.

Table of Differential Equations. By Mr. James Adams.

(To Dr. Thomson.)

SIR,

Stonhouse, June 14, 1817.

If in your opinion the following table of differential equations be likely to prove useful, I will thank you to print it in the *Annals of Philosophy*, and you will oblige,

Sir, your humble servant,

JAMES ADAMS.

The table is formed from the expression $d(x^x) = x^x (d y l x + \frac{y d x}{x})$, and the known differentials of the sines, cosines, &c. of circular arcs: l signifies Napierian logarithm.

1. $d(\sin. x^{\sin. x}) = d x (\sin. x)^{\sin. x} \cos. x \{l \sin. x + 1\}$
2. $d(\sin. x^{\cos. x}) = d x (\sin. x)^{\cos. x} \sin. x \{(\cot. x)^2 - l \sin. x\}$
3. $d(\sin. x^{\tan. x}) = d x (\sin. x)^{\tan. x} \{l \sin. x (\sec. x)^2 + 1\}$
4. $d(\sin. x^{\cot. x}) = d x (\sin. x)^{\cot. x} (\cot. x)^2 \{(\sec. x)^2 l \sin. x + 1\}$
5. $d(\sin. x^{\sec. x}) = d x (\sin. x)^{\sec. x} \operatorname{cosec}. x \{(\tan. x)^2 l \sin. x + 1\}$
6. $d(\sin. x^{\operatorname{cosec}. x}) = d x (\sin. x)^{\operatorname{cosec}. x} \operatorname{cosec}. x \cot. x \{1 - l \sin. x\}$

7. $d(\cos. x^{\sin. x}) = d x (\cos. x)^{\sin. x} \cos. x \{l \cos. x - (\tan. x)^2\}$
8. $d(\cos. x^{\cos. x}) = -d x (\cos. x)^{\cos. x} \sin. x \{l \cos. x + 1\}$
9. $d(\cos. x^{\tan. x}) = d x (\cos. x)^{\tan. x} (\tan. x)^2 \{(\operatorname{cosec}. x)^2 l \cos. x - 1\}$
10. $d(\cos. x^{\cot. x}) = -d x (\cos. x)^{\cot. x} \{(\operatorname{cosec}. x)^2 l \cos. x + 1\}$
11. $d(\cos. x^{\sec. x}) = d x (\cos. x)^{\sec. x} \tan. x \sec. x \{l \cos. x - 1\}$
12. $d(\cos. x^{\operatorname{cosec}. x}) = -d x (\cos. x)^{\operatorname{cosec}. x} \sec. x \{(\cot. x)^2 l \cos. x + 1\}$

13. $d(\tan. x^{\sin. x}) = d x (\tan. x)^{\sin. x} \cos. x \{l \tan. x + (\sec. x)^2\}$
14. $d(\tan. x^{\cos. x}) = d x (\tan. x)^{\cos. x} \sin. x \{(\operatorname{cosec}. x)^2 - l \tan. x\}$
15. $d(\tan. x^{\tan. x}) = d x (\tan. x)^{\tan. x} (\sec. x)^2 \{l \tan. x + 1\}$
16. $d(\tan. x^{\cot. x}) = d x (\tan. x)^{\cot. x} (\operatorname{cosec}. x)^2 \{1 - l \tan. x\}$
17. $d(\tan. x^{\sec. x}) = d x (\tan. x)^{\sec. x} \operatorname{cosec}. x \{(\sec. x)^2 + (\tan. x)^2 l \tan. x\}$

$$18. d(\text{tang. } x^{\text{cosec. } x}) = d x (\text{tang. } x)^{\text{cosec. } x} (\text{cosec. } x)^2 \{ \text{sec. } x - \cos. x \text{ l tang. } x \}$$

$$19. d(\cot. x^{\sin. x}) = d x (\cot. x)^{\sin. x} \cos. x \{ \text{l cot. } x - (\text{cosec. } x)^2 (\text{tang. } x)^2 \}$$

$$20. d(\cot. x^{\cos. x}) = -d x (\cot. x)^{\cos. x} \sin. x \{ \text{l cot. } x + (\text{cosec. } x)^2 \}$$

$$21. d(\cot. x^{\text{tang. } x}) = d x (\cot. x)^{\text{tang. } x} (\text{sec. } x)^2 \{ \text{l cot. } x - 1 \}$$

$$22. d(\cot. x^{\cot. x}) = -d x (\cot. x)^{\cot. x} (\text{cosec. } x)^2 \{ \text{l cot. } x + 1 \}$$

$$23. d x (\cot. x^{\text{sec. } x}) = d x (\cot. x)^{\text{sec. } x} \text{tang. } x \text{ sec. } x \{ \text{l cot. } x - (\text{cosec. } x)^2 \}$$

$$24. d x (\cot. x^{\text{cosec. } x}) = -d x (\cot. x)^{\text{cosec. } x} (\text{cosec. } x)^2 \{ \cos. x \text{ l cot. } x + \text{sec. } x \}$$

$$25. d(\text{sec. } x^{\sin. x}) = d x (\text{sec. } x)^{\sin. x} \cos. x \{ \text{l sec. } x + (\text{tang. } x)^2 \}$$

$$26. d(\text{sec. } x^{\cos. x}) = d x (\text{sec. } x)^{\cos. x} \sin. x \{ 1 - \text{l sec. } x \}$$

$$27. d(\text{sec. } x^{\text{tang. } x}) = d x (\text{sec. } x)^{\text{tang. } x} (\text{sec. } x)^2 \{ \text{l sec. } x + (\sin. x)^2 \}$$

$$28. d(\text{sec. } x^{\cot. x}) = d x (\text{sec. } x)^{\cot. x} \{ 1 - (\text{cosec. } x)^2 \text{ l sec. } x \}$$

$$29. d(\text{sec. } x^{\text{sec. } x}) = d x (\text{sec. } x)^{\text{sec. } x} \text{tang. } x \text{ sec. } x \{ \text{l sec. } x + 1 \}$$

$$30. d(\text{sec. } x^{\text{cosec. } x}) = d x (\text{sec. } x)^{\text{cosec. } x} \cot. x \text{ cosec. } x \{ (\text{tang. } x)^2 - \text{l sec. } x \}$$

$$31. d(\text{cosec. } x^{\sin. x}) = d x (\text{cosec. } x)^{\sin. x} \cos. x \{ \text{l cosec. } x - 1 \}$$

$$32. d(\text{cosec. } x^{\cos. x}) = -d x (\text{cosec. } x)^{\cos. x} \sin. x \{ \text{l cosec. } x + (\cot. x)^2 \}$$

$$33. d(\text{cosec. } x^{\text{tang. } x}) = d x (\text{cosec. } x)^{\text{tang. } x} \{ (\text{sec. } x)^2 \text{ l cosec. } x - 1 \}$$

$$34. d(\text{cosec. } x^{\cot. x}) = -d x (\text{cosec. } x)^{\cot. x} (\text{cosec. } x)^2 \{ \text{l cosec. } x + (\cos. x)^2 \}$$

$$35. d(\text{cosec. } x^{\text{sec. } x}) = d x (\text{cosec. } x)^{\text{sec. } x} \text{cosec. } x \{ (\text{tang. } x)^2 \text{ l cosec. } x - 1 \}$$

$$36. d(\text{cosec. } x^{\text{cosec. } x}) = -d x (\text{cosec. } x)^{\text{cosec. } x} \cot. x \text{ cosec. } x \{ \text{l cosec. } x + 1 \}$$

$$37. d(\log. x^{\log. x}) = (\log. x)^{\log. x} \left\{ \frac{d \log. x}{x} + \frac{d x \log. x}{x^2} \right\}$$

$$38. d(x^m) = x^m \left\{ m \text{ l } x + \frac{m d x}{x} \right\} = x^m \left(0 + \frac{m d x}{x} \right) = m x^{m-1} d x$$

ARTICLE IX.

Experiments on the Composition and Properties of the Naphtha of Amiano. By M. Theodore de Saussure. Read to the Society of Natural Philosophy and Natural History of Geneva.*

AFTER ascertaining that alcohol and ether may be represented by olefiant gas and a certain quantity of water, which predominates in the alcohol, I was led to examine whether several other inflammable bodies, of which I shall hereafter give the analysis, might not be subjected to the same law.

One of the first substances which I examined with this object in view is the naphtha† found at Amiano, in the states of Parma, which differs in several remarkable properties from the essential oils. If it were more common, it might advantageously supply the place of oil of turpentine for a variety of purposes. It is more volatile, is at least as good a solvent, has a less tenacious odour, is not liable to become coloured and thick, to be decomposed by the action of air and light, and is scarcely altered by the action of the most powerful chemical agents, such as the mineral acids and the fixed alkalis. As the properties of this bitumen have not been correctly determined, I make it the subject of the present paper.

The knowledge of naphtha is very ancient. Dioscorides and Pliny distinguish by this name a volatile combustible liquid, either white or black, which sometimes issues from the earth, and sometimes collects on the surface of water. They observe that it catches fire at a little distance from an inflamed body; they describe it as found in the same parts of Sicily, Syria, and the Archipelago, where it occurs at present.

We do not know the causes that lead to the formation of naphtha in the bosom of the earth. We know only that when asphaltum is decomposed in close vessels by heat, it yields petroleum and naphtha: and that petroleum, which is a heavier and less volatile oil than naphtha, yields it also when thus treated. The asphaltum found in the Val-de-Travers, in Switzerland, appears to have an animal origin. The rock which furnishes it, or which is penetrated with it, is almost entirely composed of shells, and exhibits no trace of vegetables. There is no coal in that country; but we meet with a great deal of sulphate of lime. The mines of asphaltum in the department of the Ain are without any coal in their neighbourhood; but we find animal petrifications and metalline sulphates. It is probable from this that this kind of bitumen may sometimes owe its origin to the action of sulphuric acid on animal substances.

* Translated from the *Bibliothèque Universelle*, iv. 116, for Feb. 1817.

† The petroleum of Amiano, which yields abundance of this naphtha when distilled, costs at Genoa only eight centimes the pound, and is employed to light the streets of the city. (*Ann. de Chim.* tom. xlv.)

Rectified naphtha is quite volatile at the ordinary temperature of the atmosphere; but there is reason to suspect that it does not occur naturally in that state. It is usually contaminated with petroleum, which may be separated by repeated distillations, and with which it has been often confounded. The natural naphtha of Amiano appears at its source in its state of impurity as a transparent yellow liquid, with a great degree of fluidity, and having a specific gravity of 0·836. When I drew off by a very slow distillation about a fourth of this substance, I obtained a transparent, colourless liquid, as fluid as alcohol, and having the specific gravity of 0·769 at the temperature of 59°. On distilling this liquid twice more, and retaining only the portions that came over first, it differed very little in its appearance from what I first obtained, and its specific gravity was 0·758 at the temperature of 66°. This density was not diminished by subsequent distillations, even when they were made off a great quantity of muriate of lime. It is to this liquor thus rectified that all the properties which I shall assign to naphtha belong. It was interesting to compare them with the properties of naphthas obtained from a different source; but the naphtha of Amiano is the only one which I could procure in sufficient abundance for a rigid examination. The naphthas which I procured in small quantities by the distillation of the petroleum of Gabian, and of the asphaltum of the department of the Ain, appeared to me to possess, after repeated distillations, the specific gravity of the naphtha of Amiano, the same fluidity, and nearly the same volatility. They had the same action on alcohol, on the mineral acids, and on the alkalis. They did not differ from pure naphtha, except by having a slight shade of yellow. I deprived them of it by distilling them from sulphuric acid; but they became again yellow by exposure to the light; which is not the case with rectified naphtha of Amiano. Notwithstanding this difference, I think that all these naphthas should be considered as identical in their essential principles.

Impure naphtha has usually a strong, penetrating, and very lasting odour. That of pure naphtha is weak and fugitive. It is almost without taste.

It catches fire at a small distance from an inflamed body, and burns with a white flame mixed with much soot.

On paper it forms a stain, which disappears in a few minutes, even in the lowest temperatures.

According to most authors, naphtha becomes yellow when exposed to the air and to light; it thickens at the same time, and is converted into petroleum. But such marked results have probably been observed only in naphtha already contaminated with petroleum. In my experiments air and light have had no very sensible action on pure naphtha. I exposed to the sun for 15 days naphtha in contact with 20 times its bulk of air, without observing any change. The experiment was continued for 18 months in a diffuse light, and the volume of the air diminished only one hundredth part. The alteration which it had undergone was scarcely sensible to the eudiometer.

The whiteness and specific gravity of the naphtha were not perceptibly altered. The impure naphtha of Amiano deepens in colour when exposed to the light, absorbing oxygen very sensibly. The colourless naphtha obtained by a distillation continued too long, and which has a greater specific gravity than I have indicated for the most complete rectification of this bitumen, becomes yellow in the same manner; but pure naphtha (of the specific gravity 0.758) which I left exposed to the light in phials only half full, has undergone no evident alteration in three years. It is possible, however, that some change may take place hereafter, in consequence of the small absorption of air which I have noticed above.

Naphtha may be totally distilled over several times in a moderate heat without undergoing any decomposition.

Of the Vapour of Naphtha.—The elasticity of the vapour of naphtha (of the specific gravity 0.7581) is equal to 0.0453 metre (1.78 inch) of mercury at the temperature of 72.5°. Hence it boils at the temperature of 186°. The elasticity of that vapour is deduced from the dilatation which air underwent over mercury when naphtha was let up into it. This air dilated in the ratio of 100 : 106.67 at the same temperature. This tension, ascertained at the same time in the vacuum of a barometer, was found to amount to 0.0465 metre (1.83 inch). But this last method may be less exact, because naphtha absorbs very quickly a considerable quantity of atmospheric air, which is disengaged in a vacuum, and which cannot be got rid of without putting the liquor again in contact with the external air. The vapour of naphtha has an elastic force four times as great as that of oil of turpentine, which has the greatest elasticity of all the essential oils properly so called.

The density of the vapour of naphtha is 2.833, supposing that of common air to be 1. It will be 2.567 if we suppose that of oxygen gas 1. This density was obtained by taking the weight of air saturated with naphtha at the common atmospheric temperature, and following the process for determining the weight of gases. For this operation the air was impregnated with naphtha over mercury in a receiver without lute, and shut by a glass stop-cock, to which was attached a globular vessel exhausted of air, which was to be filled with the air impregnated with naphtha. I found that at the temperature of 72.5°, and when the barometer stood at 0.72525 metre (23.55 inches), the weight of common air is to that of air impregnated with naphtha as 1 : 1.145. The density and the tension of the vapour of naphtha appear a little less when this liquor swims upon water, and when we employ that liquid instead of mercury to shut the receiver.

Air impregnated with the vapour of naphtha has several remarkable properties. This vapour is scarcely absorbed by water. It may be passed a great number of times through that liquid, and even kept over water, without losing its principal characters.

The presence of this vapour in some carbureted hydrogen gases may occasion a mistake respecting their composition. Thus by dis-

tilling over the naked fire different specimens of petroleum, I obtained over water towards the beginning of the process a carbureted hydrogen gas, which, after being washed by a solution of potash, had a specific gravity greater than that of any carbureted hydrogen known. It was 1.1129, supposing that of air to be 1. 100 parts in volume of this gas required for complete combustion 355 of oxygen gas, and formed 220 of carbonic acid gas. It broke in pieces eudiometers of glass which had remained entire under the same circumstances when olefiant gas was detonated in them. I thought at first that I had obtained a new gas; but on observing that naphtha was produced by the distillation of petroleum, and that on the supposition that the new gas was olefiant gas saturated with naphtha, it would have almost the same specific gravity that I found it to have, I concluded that my supposition was well founded.*

Common air saturated with the vapour of naphtha (which I shall call *naphthated air*) burns like carbureted hydrogen gas when placed in contact with a burning body, but cannot be kindled by electricity. This is the case also with naphthated oxygen gas.

When a measure of naphthated air is mixed with a measure of hydrogen gas, the mixture cannot be fired by electricity; so that if this test were alone attended to, we might conclude that no oxygen gas was present. It is necessary to add a greater dose of oxygen before combustion will take place.

A very small quantity (a 20th, for example) of hydrogen gas, when added to naphthated oxygen, enables the vapour to be kindled by electricity, and the strongest glass eudiometers are broken by the violence of the detonation.

If at the common temperature of the air we put a stick of phosphorus into naphthated air standing over water, the oxygen of the air is not absorbed. We must apply a heat sufficient to melt the phosphorus before a diminution of volume takes place.

Nitrous gas and the alkaline hydro-sulphurets absorb the whole of the oxygen from naphthated air. We may, therefore, by the difference in the result of the eudiometrical processes with phosphorus at the common temperature and the hydro-sulphurets, judge of the presence of certain emanations in air.

I put some peas with water under mercury into a receiver filled with naphthated air. They germinated as readily as in the same quantity of pure atmospherical air; but they vegetated a longer time in this last, and their action on the air was different. In common air the grains replace the oxygen which they absorb by the same volume of carbonic acid gas, and of course do not alter the bulk of their atmosphere. But as soon as they have absorbed all the

* The analysis does not agree exactly with that supposition. But the olefiant gas ought to be somewhat modified by the strong heat necessary to distil petroleum. Besides, the analysis can be made only on a small quantity of the gas which I examine, because we are obliged to mix it with six times its volume of oxygen to enable the eudiometer to resist the detonation.

oxygen, they dilate it by an emission of carbonic acid gas. These results are the same with dead and dying grains; but in naphthated air the grains form more carbonic acid gas than they absorb of oxygen gas; or, in other words, they dilate their atmosphere by an emission of carbonic acid gas before they have absorbed all the oxygen. This is not because the grains suffer more in naphthated air than in common air; for in this last the dead and dying grains replace all the oxygen by an equal emission of carbonic acid gas. But the cause of the difference is the influence of the oxygen of naphthated air is partly neutralized by the vapour of naphtha; just as the influence of the oxygen on phosphorus while cold is destroyed by the presence of that vapour, which renders the oxygen in certain respects analogous to azotic gas. It is probable from this that the hurtful action of certain odours on the animal economy depends in some cases on a similar cause, and not always on the direct influence of these odours on our nerves.

Water.—Naphtha is insoluble in water; but that liquid becomes impregnated with the odour peculiar to that bitumen. When a drop of naphtha is let fall on the surface of water, it spreads, and assumes the appearance of a thin pellicle, at first colourless, but speedily becoming thinner, and assuming the finest tints of the rainbow, and speedily disappearing by evaporation. This play of colours has been long observed with water and petroleum. With them it is permanent, on account of the fixity of the petroleum. I kept for some years pure naphtha in contact with water and air in a close phial, and these liquors have not been sensibly modified.

Alcohol.—Naphtha is considered as insoluble in alcohol; but I have found that absolute alcohol dissolves it in every proportion. Alcohol at 41° of Beaumé's areometer dissolves a fifth of its weight of naphtha, and an eighth when it is at 36° of that areometer. This liquid dissolves so much less naphtha the more it is mixed with petroleum. The solubility of naphtha in alcohol more or less diluted with water is nearly the same as that of oil of turpentine.

Sulphuric ether, petroleum, fat oils, pitch, essential oils, combine cold with naphtha in every proportion.

Camphor.—Naphtha dissolves cold the three-fourths of its weight of camphor. When hot, it dissolves a still greater proportion, which precipitates as the liquid cools in a spongy state.

Amber does not dissolve in naphtha. *Shell lac* and *copal* are almost insoluble in it. The decoction of them, made in an open vessel, does not contain one hundredth part of its weight of these bodies in solution.

White wax may be mixed cold with naphtha. A milky liquid is produced, which deposits wax in a state of great division, and which exhibits at its surface a transparent solution, containing but little wax. By the assistance of heat the wax dissolves in every proportion in this bitumen. The hot solution, on cooling, coagulates into an opaque paste, if the naphtha is in small quantity. But

if it is very superabundant, we obtain an opaque, pasty deposit in a transparent liquid holding the eleventh part of its weight of wax in solution.

When *caoutchouc* is macerated in naphtha, it swells in a most extraordinary manner. It becomes at least 30 times more bulky than in its primitive state, without changing its shape in the liquid. The naphtha, after a maceration continued for 48 hours, contains in solution only the seven thousandth part of its weight of *caoutchouc*. By boiling, and partially evaporating the liquid, we obtain more concentrated solutions. They form a varnish, which dries readily, and which presents the elastic substance almost colourless, but possessed of all its properties; but the *caoutchouc* never dissolves completely in these processes. The insoluble residue has the appearance of a gelatinous matter, impregnated with naphtha, which, when dried, is reduced to a very small volume, exhibiting an elastic substance like *caoutchouc*. It appears from this that naphtha divides *caoutchouc* into two elastic substances, the one more, the other less soluble in this menstruum. The last retains the colouring matter.

Sulphur is not sensibly attacked in the cold by naphtha. By boiling, a portion of it is dissolved, which does not exceed the 12th part of the weight of the liquid. The solution is yellow and transparent. It becomes colourless on cooling, depositing the sulphur crystallized in fine needles, which are long, and very brilliant, but which afterwards break of themselves, and become tarnished. The naphtha retains in solution, after cooling, a small quantity of sulphur, which is partly carried out of the vessel by the spontaneous evaporation of the liquid, and which is deposited in powder on the surrounding bodies. This solution leaves for residue some microscopic crystals of sulphur.

Phosphorus.—A hundred parts of naphtha, at the heat of ebullition, dissolve six or seven parts of phosphorus. The phosphorus partly precipitates in drops and in powder as the liquid cools. After this precipitation, the decanted liquor deposits in a few days prismatic crystals of phosphorus.

Chlorine.—I caused a rapid current of chlorine in the state of gas to pass for an hour and a half through eight grammes ($123\frac{1}{4}$ grains) of naphtha. The liquor became hot, and the chlorine separated in the state of muriatic acid. After this operation the naphtha smoked, in consequence of the presence of the acid, with which it was impregnated. It gradually lost this property, and then exhibited a fluid oil, which was volatile and inflammable, but a little less volatile than naphtha. By that operation it acquired the sp. gr. 0.884, or somewhat more than it was before. It was become more soluble in aqueous alcohol, and was more easily altered by the mineral acids. Its smell was analogous to that of thyme. It became brown by the action of air. In other respects, the changes which the naphtha underwent by this experiment were not very remarkable.

Iodine does not dissolve cold in naphtha, except in a very small proportion; about one-eighth of the weight of the liquid. This

solution, which has a deep purple colour, carries off it, when it evaporates, all the iodine which it contains.

Mineral Acids.—The acids have little action on naphtha. Concentrated sulphuric acid has no action in the cold. When a mixture of one part naphtha and two parts of sulphuric acid are distilled, traces of sulphurous acid are disengaged without effervescence. The alteration which the naphtha might have received was not observed.

White and fuming nitric acid exhibits no other mark of acting on naphtha in the cold than a very slight yellow shade which it acquires. This result may serve to distinguish naphtha from the essential oils and from petroleum, or to ascertain whether the naphtha is not mixed with one of these fluids, especially with oil of turpentine, which is often employed to sophisticate it. Nitric acid added to such a mixture becomes brown in a few minutes.

Naphtha introduced over mercury into a receiver full of *muriatic acid gas* only absorbs $2\frac{1}{2}$ times its bulk of it. The liquid is found unchanged after it has given out in the air the gas which it had absorbed. The essential oils act very differently. The rectified oil of lavender absorbed 210 times its volume of muriatic acid gas without being saturated, and changed at the same time from pale yellow to blackish red. Oil of turpentine was saturated by absorbing 163 times its volume of this gas. It formed the camphorated matter which is one of the remarkable products of this absorption.

Fixed Alkalies.—The hydrates of potash and soda in fragments are scarcely attacked by naphtha. I have kept them for several months in this bitumen without their undergoing any other change than a slight brown cloud upon some parts of their surface. When the mixture is boiled, the liquid scarcely becomes muddy. Brown flocks are formed, but in too small quantity to be subjected to any examination. Naphtha underwent no change when boiled with a concentrated solution of potash in water. It is known that Sir H. Davy, while employing this bitumen to preserve potassium and sodium, first perceived that they did not undergo any alteration in it when it had not been in contact with the air; but that in that case an alkali was formed, which, by uniting with the oily liquid, produced a brown soap. Since the alkalies in the state of hydrate do not form a sensible quantity of this soap, we must conclude that it is not formed except when the oxide of potassium and sodium are not in the state of hydrate. Naphtha is very easily impregnated with atmospheric air; and we ought to ascribe to this prompt absorption the alteration which potassium and sodium undergo in that liquid when exposed to the air.

Ammonia.—Naphtha is capable of absorbing only $2\frac{1}{2}$ times its volume of ammoniacal gas at the mean temperature of the atmosphere. The liquid does not become muddy by this penetration. Oil of turpentine exhibits the same results. But the essential oil of lavender absorbs 47 times its volume of this gas, and becomes muddy by this absorption. Naphtha forms with ammonia dissolved in water a white pellicle, which is insoluble. This product, which

is always very scanty, does not liquify at the temperature of boiling water. It is destroyed by long exposure to the air.

Sugar, gums, and starch, do not dissolve in naphtha.

Decomposition of Naphtha in a red-hot Porcelain Tube.—I distilled slowly 22·43 grammes of naphtha through a red-hot porcelain tube, connected with a long glass tube surrounded with cold water, with a small globular vessel, and with the pneumatic trough. The distillation lasted seven hours, and furnished,

1. In the porcelain tube 4·7 grammes of very dense charcoal, having the metallic lustre, and similar to that obtained by decomposing the essential oils in the same way.

2. 4·13 grammes of a brown empyreumatic oil mixed with naphtha and charcoal in a very divided state. This oil, by sublimation at the temperature of 95°, yielded about a gramme of colourless crystals in rhomboidal plates, thin, transparent, shining, and often truncated on their acute angles. This substance, which is volatile, inflammable, insoluble in water, inalterable by exposure to the air, and having a strong empyreumatic odour mixed with that of benzoin, appears to me to be the same as that which is produced in the decomposition of ether, alcohol, and the essential oils, by the same process. The residue of this sublimation, being treated with ether, was dissolved by that liquid, excepting a pasty matter like pitch, which weighed 0·71 gramme. This solution, when sufficiently concentrated, appeared yellow by transmitted, and green by reflected, light. Petroleum alone, when rectified and concentrated, has the same property.

3. 9·697 grammes of carbureted hydrogen gas; the first third of which had a specific gravity of 0·37368, abstracting $\frac{2}{100}$ of azote which was mixed with it, and which might have been furnished by the water of the trough. 100 parts in volume of this gas consumed 135·5 of oxygen, forming 65·36 of carbonic acid gas. Hence it follows that 100 of this gas contain by weight 72·72 carbon and 27·5 hydrogen. The specific gravity of the last third was 0·4413. 100 parts in volume of this gas consumed 153·25 of oxygen gas, forming 77·17 of carbonic acid. The absence of oxygen in this gas is a strong proof that it does not exist in naphtha.

In this analysis there was a loss of 3·9 grammes. It was owing to a brown oily smoke which was carried into the water of the trough.

Analysis of Naphtha by the Detonation of its Vapour in Oxygen Gas.—I introduced over mercury 94·5 milligrammes of naphtha into 1078 cubic centimetres of oxygen gas contaminated with $\frac{2}{100}$ of azote at the temperature of 65°, and when the barometer stood at 28·23 inches, when reduced to the temperature of 32°. After some hours, all the naphtha disappeared; for that there might not be naphtha in excess, besides that which was in the state of vapour, I had taken care that the quantity of this bitumen was much less than was requisite to saturate the gas. The mixture occupied under the circumstances above stated 1104·5 cubic centimetres. I added

to it $\frac{1}{10}$ of hydrogen gas; and, after detonating the mixture by electricity, I found that, supposing the gas reduced to the volume which it would occupy under a pressure of 0.76 metre (29.92 in.) and at the temperature of 32° , the naphtha alone had consumed 217.72 cubic centimetres of oxygen gas in order to produce water, and 153.93 cubic centimetres of carbonic acid gas.

A solution of neutral nitrate of mercury added to the water, formed by the slow combustion of naphtha, mixed with sand in a close tube, heated by a lamp, and which contained 250 cubic centimetres of oxygen gas, indicated the presence of a little ammonia. The quantity of this alkali, estimated by a process which I have described in the *Bibliothèque Britannique* (lvi. 347), indicated a portion of azote which amounts at the most to one hundredth part of the weight of the naphtha. When I detonated in a eudiometer the vapour of naphtha with oxygen gas mixed with azote, this last gas rather diminished than augmented by the combustion. These results show that the quantity of azote contained in naphtha must be very small.

According to these data, 100 parts of naphtha contain in weight, abstracting the azote,

Carbon	87.6
Hydrogen	12.78
	100.38

I did not obtain from the combustion of naphtha in the open air, and at the orifice of a serpentine, a quantity of water sufficient to subject it to a rigid examination; and I do not conceal that the composition of this bitumen, deduced (as I have done in some analogous analyses) from the consideration only of the quantity of oxygen consumed, and of carbonic acid produced, by the combustion, is liable to some uncertainty. But I have employed the only process which the present state of the science appeared to offer for analyzing a substance so volatile, and so difficult to decompose, as naphtha.

To find the ratio of the volume of the vapour of naphtha, and that of its elements, we may admit, taking oxygen gas for unity, that the density of the vapour of carbon is 0.754, and that of hydrogen gas 0.0663. The application of these values to the analysis of naphtha shows that its vapour (whose density we determined by experiment at 2.567) contains five volumes of hydrogen gas and three volumes of the vapour of carbon, and that the re-union of these elements into a single volume gives the number 2.597, which approaches sufficiently to the density of the vapour of naphtha to induce us to consider the two results as the same.

If we make this comparison, assuming 2.833 for the density of the vapour of naphtha, atmospheric air being considered as 1, and admitting, with Gay-Lussac, that the density of the vapour of carbon is 0.416, and that of hydrogen 0.0732, we shall find that

naphtha is composed of six volumes of the vapour of carbon and of five volumes of hydrogen gas condensed into one ; for this will give the density 2·862, very near 2·833, the density of the vapour of naphtha found by experiment.

When we set out from the consideration of volumes to rectify the analysis, 100 of naphtha contain in weight

Carbon	87·21
Hydrogen	12·79
	100·00

In the combustion of naphtha thus constituted, the oxygen gas consumed is to the carbonic acid gas produced as 100 : 70·59.

We conclude from this analysis that naphtha is a carbureted hydrogen containing more carbon than olefiant gas, which consists by weight of 85·03 parts of carbon and 14·97 of hydrogen.

ARTICLE X.

ANALYSES OF BOOKS.

Le Règne Animal distribué d'après son Organisation, &c. Par Le Chevalier G. Cuvier, 4 tom. 8vo. Paris, 1817.

In the preface the author professes to give a short account of all the *genera* of animals that have been established by authors ; and for the purpose of rendering them intelligible to students, for whom the work is intended, he proposes to throw them under great generic heads, and to denominate them *sub-genera*, suffering them to retain their names, in order to assist the memory.* He rejects the use of technical language, as far as possible ; and mentions the authors to whom he is indebted for peculiar views.

The introduction is highly interesting : In it he speaks of the systems of natural history in general, and discusses the differences between animals and vegetables ; † but although we have not time to enter into this part of the subject, which is foreign to our purpose, yet we cannot but express our surprise at his maintaining the exploded opinion that vegetables absorb the carbonic acid emitted by the respiration of animals ! He treats too of organic elements, of their functions and application, in a manner that does him but little credit.

He next treats of the general distribution of animals, which he divides, as in his paper in the *Annales du Muséum*, into four types (*embranchements*).

* Following the Linnæan method of dividing papilio, phalæna, gryllus, &c.

† Animals and vegetables respire, and change the absorbed nutriment into fluids necessary for their support, increase, &c. : but the line of distinction is as obscure as ever.

Type 1. *Vertebrata*.—Brain and principal nervous cord enveloped in a bony case, composed of the skull and vertebræ. Muscles attached to the bones.

Type 2. *Mollusca*.—Brain or principal part of the nervous system placed near the œsophagus. Muscles attached to the skin.

Type 3. *Articulata*.—Nervous system composed of two longitudinal knotted cords placed in the belly. Muscles attached to the external covering, which is generally hard, and is always articulated.

Type 4. *Radiata*.—No distinct nervous system. Body radiated. M. Cuvier has given the characters of each type at full length, and has then divided each into classes. *

Type I.—VERTEBRATA.

- Class 1. *Mammalia*.
 2. *Aves*.
 3. *Reptilia*.
 4. *Pisces*.

Type II.—MOLLUSCA.

- Class 5. *Cephalopoda*.
 6. *Pteropoda*.
 7. *Gasteropoda*.
 8. *Acephala*.
 9. *Brachiopoda*. Genera: *Lingula* and *Terebratula*.
 10. *Cirrhopoda*.

Type III.—Articulata.

- Class 11. *Annelides*. Worms with red blood.
 12. *Crustacea*.
 13. *Arachnides*.
 14. *Insecta*. †

Type IV.—Radiata.

- Class 15. *Echinodermata*.
 16. *Intestina*.
 17. *Acalephæ*. Medusa, actinia, &c.
 18. *Polypoda*.
 19. *Infusoria*.

In the detail M. Cuvier has shown a degree of carelessness and inconsistency that we should not have expected from the author of the following passage:—"La détermination précise des espèces et

* Where the classes are different from those mentioned in our preceding numbers, we shall give an example of one or more genera.

† The third volume, which is by far the best, contains the classes crustacea, arachnides, and insecta, and was written by Latreille, who, from his friendship for Cuvier, has sacrificed all his principles, in order to render this part a piece with the rest of the work.

de leur caractères distinctifs fait la première base sur laquelle toutes les recherches de l'histoire naturelle doivent être fondées; les observations les plus curieuses, les vues les plus nouvelles perdent presque tout leur mérite quand elles sont dépourvues de cet appui; et malgré l'aridité de ce genre de travail c'est part là que doivent commencer tous ceux qui se proposent d'arriver à des résultats solides." He has even referred to a figure of a *mermaid* for his *dugong*!! (Vol. i. p. 275) and has placed the *argonauta*, *nautilus ammonites*, &c., whose animals are unknown, amongst the cephalopoda: and although he has placed *unio* and *anodonta*, whose animals are exactly similar, as two distinct genera; yet he has considered *mytilus* and *modiola*, whose animals are different, as sub-genera!

We might fill a number of our *Annals* with an enumeration of the inaccuracies and inconsistencies of the author. Those given, however, will suffice to show that the work must be used by students with a great deal of caution. We wish, however, fully to be understood to admit, that it contains more information than any other introductory work, and a quantity of very valuable matter, which is generally put together with haste and carelessness. The plates are very bad, and in some instances incorrect. It is the worst of Cuvier's productions.

II. *Essay on the Origin, Progress, and present State of Galvanism: containing Investigations, experimental and speculative, of the principal Doctrines offered for the Explanation of its Phenomena, and a Statement of a new Hypothesis. Honoured by the Royal Irish Academy with the Prize. By M. Donovan.*—Dublin, 1816. 8vo.

This is a work of no ordinary merit, and does great credit to the author, both for the extensive knowledge of the subject which it displays, the acuteness with which the different theories are examined, and the ingenuity displayed in the contrivance of the new hypothesis, by which he endeavours to account for the different phenomena. The scientific world lie under considerable obligation to the Royal Irish Academy for having occasioned the composition of so ingenious a performance: and Mr. Donovan promises fair, if he persevere in the career which he has so happily begun, to do credit to his country, and to contribute materially to the improvement of those sciences to which he has devoted his attention. Chemistry is already indebted to his sagacity for the discovery of the *sorbic acid*, which had even escaped the indefatigable Scheele. The present essay does still greater credit to his abilities. If we cannot always subscribe to the soundness of his opinions, we never fail to be struck with the ingenuity which he displays; and he seldom loses sight of that urbanity of manner with which the opinions of men of science, even when erroneous, ought always to be treated.

The essay is divided into three parts. In the first he gives a

sketch of the history of galvanism; in the second he explains and discusses the different hypotheses by which the galvanic phenomena have been accounted for; and in the third he gives his own new hypothesis of galvanism.

The history of galvanism he divides into four periods: 1. The phenomena observed before the era of galvanism properly so called. These were the shocks given by the fish called the torpedo. An observation of Du Verney, nearly the same with the fact afterwards detected by Galvani, that when the nerves going to the thighs and legs of a newly killed frog are touched with a scalpel, the parts below them are thrown into convulsions.* Sultzzer, in 1767, observed that when a piece of silver in contact with lead is applied to the tongue, a peculiar taste is perceived, though neither metal by itself gives any taste. In 1787 Mr. Bennet discovered that certain metals, after contact with each other, became feebly, but distinctly, electric.

2. The second period begins in 1791, when Galvani discovered muscular contractions effected by simple metallic associations, and continues till the discovery of the voltaic pile by Volta in 1799. The experimenters during this period were numerous, and the facts discovered curious. Mr. Donovan attaches a greater value to Humboldt's experiments made at this time than has generally been done by those who have turned their attention to this branch of the subject.

3. The third period contains the gradual developement of the physical and chemical powers of combined galvanic arrangements. This period goes only to the commencement of 1804. The principal experimenters were Nicholson and Carlisle, Cruikshanks, Davy, Wollaston, and Ritter.

4. The fourth period contains the generalization of the chemical effects of galvanism; and the discoveries that have resulted from the application of a general principle. Here the principal experimenters were Berzelius, Ritter, and, above all, Davy. Berzelius and Hisinger first generalized the law according to which bodies are decomposed by the galvanic energy; and Davy happily applied this law to the decomposition of the alkalies and earths. In this part of his history Mr. Donovan quotes the experiments of Mr. Peele. He does not appear to be aware that Mr. Peele's pretended experiments were merely a philosophical *hoax* on the public, no such experiments in fact having been ever made. He omits, too, all mention of the facts determined by Gay-Lussac and Thenard, and described by them in their *Recherches Physico-chimiques*, a book of unquestionable merit, which contains a great number of most valuable facts. I know not whether it be worth while to mention an inadvertency which pervades the whole of Mr. Donovan's book, and

* Mr. Donovan quotes for this fact Mem. Par. 1700, p. 52. In my copy of the *Memoires* of the French Academy, which is the second edition, the fact occurs in p. 40.

which, though slight, ought however to be corrected: the name of *Theodor Von Grotthus* is uniformly spelled *Grotthius*.

The second part of Mr. Donovan's essay is divided into five chapters. In the first he examines the hypothesis of Volta, who considers all the phenomena of galvanism to be produced by the agency of electricity alone. In the second he examines the hypothesis of Fabroni, who considers the phenomena of galvanism to be produced by chemical affinity alone. In the third he examines the opinion of the British philosophers, particularly Dr. Wollaston and Dr. Bostock, who united the hypotheses of Volta and Fabroni. According to them, the phenomena are produced by electricity; but the electricity is evolved by the chemical action of the constituents of the galvanic battery on each other. In the fourth chapter the hypothesis of Davy and Berzelius is examined. It is well known that they consider electricity and chemical affinity to be one and the same power. Bodies, according to them, unite when they are in opposite electrical states, and they separate when brought into the same electrical state. The object of the fifth chapter of this part is to prove that electricity is not the real agent in galvanic phenomena.

Part the third is occupied with the author's new hypothesis of galvanism. It is divided into two chapters. The first is employed in explaining the hypothesis; and the second in applying it to the principal phenomena of galvanism.

Affinity, in our author's opinion, is a property belonging to all bodies, though they cannot always unite in consequence of it, being prevented by some other circumstances. If a piece of zinc be plunged into diluted nitric acid, it immediately begins to dissolve, in consequence of the affinity between it and the acid. The same solution takes place when copper is put into diluted nitric acid. From these experiments, it is obvious that both zinc and copper have an affinity for nitric acid. If the two metals be placed in contact, and then plunged into diluted nitric acid, the zinc dissolves more rapidly than before, but the copper does not dissolve at all: therefore the copper has *transferred* its affinity for oxygen to the zinc. The zinc has acquired a stronger affinity for oxygen than before, and the copper has lost that affinity. The copper, however, effervesces, and gives out hydrogen gas. It has acquired a greater affinity for hydrogen than formerly, while the copper has lost its affinity for that principle. The zinc has *transferred* its affinity for hydrogen to the copper. The affinities of bodies may be divided into two sets. The first set consists of oxygen and acids; the second set, of hydrogen, alkalies, earths, and metals. Whenever two metals are placed in contact, one of them transfers its affinity for oxygen and acids to the other; while that other transfers its affinity for hydrogen, alkalies, earths, and metals, to the first. This transfer of affinity is the principle which, in Mr. Donovan's opinion, explains the nature and energy of the galvanic battery. In short, it constitutes the foundation of galvanism, which, in his opinion, has no connexion with electricity whatever. He illustrates

his principle with great ingenuity, and brings many valuable experiments and observations in support of his opinions; so that appear much more plausible in the essay itself than they can here when stripped of all these illustrations and experiments.

The galvanic phenomena, to the explanation of which Donovan applies his hypothesis, are the following:—

1. *Metallic Arborizations*.—It is generally known that if a plate of copper be immersed in a solution of silver in nitric acid silver is precipitated in the metallic state, while the copper is dissolved. In the same way, when zinc is immersed in acetic acid, lead, the zinc dissolves, while the lead is precipitated in the metallic state. The precipitated metal in these cases usually appears in the form of long threads or crystals, arranged like the branches of a tree. Hence the phenomenon is called *arborization*. Zinc and iron throw down copper and lead in the metallic state; lead throws down copper, copper throws down bismuth, bismuth mercury, and silver. Mr. Donovan shows that his hypothesis explains these precipitations in a satisfactory manner. When zinc and copper are placed in contact, the copper transfers its affinity for oxygen and acids to the zinc, while the zinc transfers its affinity for hydrogen and bases to the copper. Hence when a plate of zinc is placed into a solution of copper, the copper losing its affinity for oxygen and the acid appears in the metallic state; while the zinc, having acquired a stronger affinity for oxygen and acids, dissolves in the place. The knowledge of the order in which these transfers place, when two metals are placed in contact, enables us to determine when arborizations will make their appearance. Mr. Donovan shows that his explanation will even apply to those cases in which the usual order of the precipitation of metals is reversed in the course of galvanic action.

2. *General Chemical Effects of Galvanism*.—These effects are the decompositions of water, acids, oxides, &c. the hydrogen and metallic base being evolved at the negative side of the galvanic battery, and the oxygen or acid at the positive side. These decompositions are ascribed to the increased affinity of the zinc for oxygen and acids, and of the copper for hydrogen and bases. The difference of affinity he conceives to be sufficient to account for these decompositions which take place.

3. *Electrical Phenomena manifested by Galvanic Arrangement*.—He considers affinity and electricity as antagonist forces. He conceives that when affinity acts with energy electricity must be evolved. This is the part of his hypothesis which Mr. Donovan seems to me to have made out in the least satisfactory manner.

4. *The Light and Heat manifested by Galvanic Arrangement*.—Heat and affinity being of opposite principles, he conceives that a sudden transfer of the one will disengage the other. And light and heat are so closely connected that we may expect them to accompany each other.

5. *The Contractions and Shock produced in Animals by Galvanism*.

Arrangements.—He is of opinion that these are produced, not by electricity, but by the chemical action of the substances applied on the muscles and nerves.

Such is a short sketch of Mr. Donovan's very curious and interesting performance. I have perused the work with considerable pleasure, and received from it not a little information. His opinions, I think, deserve a full examination. I must acknowledge, however, that his reasoning has failed to produce in my mind a conviction of the accuracy of his hypothesis. He has been at pains to inform us that by *transfer of affinity* he means merely that the affinity of one body for oxygen has increased while the same affinity in the accompanying body has undergone a proportional diminution. Now I can form no conception of the possibility of such a transfer, unless the two kinds of affinity brought into view by galvanic experiments were inherent in two fluids residing in matter, and capable of being transferred according to certain laws.

Were we to suppose the existence of two such fluids in copper and zinc, it would be easy to suppose that the fluid producing the affinity for oxygen might accumulate in the zinc, while the fluid producing the affinity for hydrogen might accumulate in the copper. With such an hypothesis for a foundation, it would not be difficult to construct a galvanic theory that would explain all the phenomena, and Mr. Donovan's treatise would greatly facilitate such an attempt. But if *affinity* be merely an *attraction* belonging to copper and zinc as matter, and this seems to be Mr. Donovan's opinion, I do not see how any such transfer as he has supposed can take place, and could not therefore admit it as the foundation of a theory of galvanism.

ARTICLE XI.

Account of some Experiments made with the Gas Blow-pipe; being a Continuation of former Observations upon the same Subject. In a Letter to the Editor by Edward Daniel Clarke, LL.D. Professor of Mineralogy in the University of Cambridge, and Member of the Royal Academy of Sciences at Berlin, &c.

(To Dr. Thomson.)

SIR,

AT the conclusion of my letter inserted in the fifty-first number of your *Annals*, published last March, I promised to renew my communications, respecting the *gas blow-pipe*, whenever any thing should occur worthy of your notice. Since that letter was written many things have happened likely to interest those who considered my former observations of any importance. In the first place it may concern them to know that this blow-pipe is completely divested of all the danger with which it menaced the ope-

rator. Observing the precautions before described, I have been able to continue the use of it, not only for my private experiments, but also during an entire course of public lectures, delivered to the Members of this University, without a single accident or interruption of any kind: and the consequence of this public use of it is, that I may now appeal to the testimony of all those, in whose presence the experiments were performed, for the truth of the statement already published, touching the results which this blow-pipe has enabled me to obtain. I shall mention only two things which I consider as being essentially requisite in all experiments where the same results may be desired. First, that, as a precaution for his safety, the operator, before igniting the gas, should apply his ear to the apparatus (gently turning the stop-cock of the jet at the same time), and listen to determine, by the bubbling noise of the oil, whether it be actually within the safety cylinder.* If there have been a partial detonation in the safety cylinder, as sometimes happens, when the gas is nearly expended, this precaution is doubly necessary; to ascertain whether the oil have not been driven into the reservoir; when an explosion of the whole apparatus would be extremely probable. Using this precaution, the diameter of the jet may be so enlarged as to equal $\frac{1}{4}$ of an inch. Secondly: If, with this diameter, the heat of the flame be not sufficient to melt a platinum wire whose diameter equals $\frac{1}{8}$ of an inch, the operator may be assured his experiments will not be attended with the results I have described; and for reasons which will presently be explained. The melting of the platinum wire of the thickness now mentioned ought to be considered as a necessary trial of the intensity of the heat; which should be such that this wire not only fuses and falls in drops before the flame, but also exhibits a lively scintillation resembling the combustion of iron wire, exposed to the same temperature.

To return, therefore, now, to the point at which my former observations were terminated. I mentioned the probable fusion of charcoal; as the only result wanted for the complete annihilation of the character of infusibility; every other substance having yielded to the powerful heat of the ignited gas. This result, as it is well known to many of your readers, has been obtained in consequence of trials instituted for the purpose, in London: it will not therefore be necessary to describe experiments undertaken with the same view, in Cambridge; because they were not attended by results equally satisfactory; especially as I have so much other matter to which your attention is now requested.

It must have appeared very remarkable to many of your readers, that while the reduction of the earths to the metallic state, and particularly of barytes, was so universally admitted by all who witnessed my experiments with the gas blow-pipe in Cambridge, the

* The oil may be drawn into the reservoir, whenever the piston is used, if the piston be not kept carefully shut, before the handle is raised.

experiments which took place at the Royal Institution for the express purpose of obtaining the same results, totally failed. This will, however, appear less remarkable, when it is now added, that my own experiments began, at length, to fail also. During the *Easter* vacation, owing to causes I could not then explain, the intensity of the heat was so much diminished in the flame of the *ignited gas*, that I was sometimes unable to effect the fusion of *platinum* wire of the thickness of a common knitting needle. The blame was of course imputed to some supposed impurity, or want of due proportion, in the *gaseous* mixture; when, to our great amazement, the intensity of the heat was again restored, simply by removing a quantity of *oil* which had accumulated in the cap of the *safety-cylinder*, and which had acquired a black colour. Afterwards, the same diminution of the temperature was observed, and it was restored by adding an excess on the side of the *hydrogen*; which instead of being mixed in the proportion of *two to one*, with the *oxygen*, was mixed in the proportion of *seven* measures of *hydrogen* to *three* measures of *oxygen*. In the latter case it is probable that the loss of heat had been caused by some impurity in the *gases*; perhaps owing to the presence of *carbonic acid gas*; and in neither of these cases ought it to be supposed that the causes which here operated to the diminution of the temperature were also the causes of *failure* at the Royal Institution.

About this time Dr. Wollaston arrived in Cambridge, and was present at some of the experiments, in company with Dr. Milner the Dean of Carlisle, and the Rev. J. Cumming, our Professor of Chemistry. Dr. Wollaston had kindly brought with him, from London, some pure *barytes*, prepared by Messrs. Allen, of Ploughcourt. It was immediately observed, that with this newly prepared *barytes*, there was no possibility of obtaining any *metallic* appearance. The *barytes* deliquesced before the *ignited gas*, and drops of a liquid caustic matter fell from it. This result of its exposure to heat reminded Professor Cumming of what he had seen at the Royal Institution. He had been present at the very experiments which were made known to the public, when it was said that they had *failed* in obtaining the results I had described. The fusion of the *barytes*, it was acknowledged by the Professor, was then precisely similar to that which he now witnessed. Hence it became evident that the *failure* both here, and at the Royal Institution, might be attributed to the same cause; namely, the impurity of the *barytes*; which proved to be, in fact, a *hydrate*; and its reduction to the *metallic* state, before the *ignited gas*, was thereby rendered impracticable.

Being in possession of this fact, I took the earliest opportunity, afforded by a visit to London, to wait upon the Chemical Lecturer at the Royal Institution; having first apprized him of my intention; requesting that he would have the goodness to repeat the experiments in my presence; that I might judge of the cause of failure. Mr. Solly, of the Geological Society, accompanied me thither.

He had been assured that Mr. Racket would also attend. We waited, however, some time in the Laboratory, without being joined, as we expected, by any of the party; and I was compelled to return to Cambridge, without witnessing the experiments.

In the beginning of the present month Dr. Ayrton Paris, well known for his philosophical writings and researches, arrived in Cambridge; and I had an opportunity of repeating my experiments in his presence. Being perfectly satisfied of the *metallic* nature of the substance obtained by the fusion of *barytes*, he expressed his conviction upon the subject, to all who were then present. "It would not," he said, "admit of a doubt:" but he offered this explanation of the phenomenon; namely, that "a portion of *iron* held in solution by *hydrogen gas*, might be deposited, during combustion, as a superficies upon the slag of the *barytes*; and thus exhibit a genuine *metallic* appearance." In answer to this, it was urged, by all present, that the same result is obtained when the *hydrogen gas* is prepared by the decomposition of *water*; without the presence of *iron*: also that if *iron* or *zinc* were thus deposited, these *metals* would be instantly liable to combustion, when exposed to such a temperature. Moreover, it was added that if the *metallic* lustre arose from *iron* or *zinc*, it would be permanent; and not so fugitive as scarcely to admit of an examination; which is the case. However, after Dr. Paris arrived in London, I received from him a letter containing a proposal so fair and candid, that as the result of it will be deemed satisfactory by himself, and as he has requested its publication, so, perhaps, making it public, I may succeed in removing from the minds of all impartial readers every doubt which may have existed upon this subject; because it seems from Dr. Paris's letter that the chemists of London are equally disposed with him to abide by the result of the trial which he proposes. I will therefore cite Dr. Paris's own words. "Your great object, I know," says Dr. Paris, "is the acquisition of truth; and I feel that no apology is necessary for freely communicating my doubts; if they be unfounded, which may easily be ascertained by experiment, a refutation should be published, which will go far to corroborate the truth of your theory. *Hydrogen gas*, when obtained by the action of a *metal* on *water*, always holds a portion of that *metal* in solution, and it may be easily shown that by combustion it is again deposited. Now I conceive that the substance held in contact with the burning stream of *gas*, RECEIVES UPON ITS SURFACE A METALLIC FILM. This idea is greatly strengthened upon a review of all the results of your experiments. Mr. Brande, to whom I communicated this suspicion, is much inclined to believe its truth. Dr. Thomson also thinks it by no means improbable. Under such circumstances, therefore, a series of experiments ought to be instituted that may quiet their doubts. The specimen, coated with *plutonium*, might be dissolved in distilled water with the addition of a few drops of nitric acid, and then assayed for *iron* or *zinc*: if either of these metals be discovered,

and at the same time the pure *barytes* be found not to contain them, the question at issue would be decided: if otherwise an account of the experiments should be published, which would show that the *metallic* lustre was derived from no foreign or adventitious ingredient." Thus far Dr. Paris; from all which it appears, that the presence of a *metal* is admitted; the only doubt consists in the nature of this *metallic* body. I am therefore to consider the question as at rest respecting the *metallic* lustre; and am only called upon to decide, to what *metal* this lustre ought to be attributed.

I might discuss this question at once, by saying that if this were really a *metal*, held in solution by *hydrogen gas*, and deposited during its combustion "as a *metallic film* upon the substance held in contact with the burning stream of gas," how comes it to pass, that it is not similarly deposited during the fusion of other refractory bodies, such as *rock crystal*, *corundum*, *zircon*, *cyanite*, &c.? Would not a similar deposition always take place under similar circumstances? The experiments, however, which have been proposed by Dr. Paris, have been all duly performed; and the following account of them will show, that the *metal* which he confesses having seen in *barytes*, is owing to "no foreign or adventitious ingredient."

Monday, July 7.—Having reduced pure *barytes* to the *metallic* state, a portion of the substance exhibiting *metallic* lustre, was exposed to the action of distilled water, containing a few drops of pure *nitric acid*. Its solution was accompanied with effervescence. *Tincture of galls* was then added; but there was not the slightest alteration of colour to denote the presence of *iron*, nor any precipitation of this metal. Afterwards the same experiment was repeated, adding only *sulphureted hydrogen* as a test for *zinc*, instead of the *tincture of galls*, but without effect. *Prussiate of potash* was also added, but there was no precipitation of *zinc*. A green colour appeared; from which appearance, *iron* might be supposed present; but it was observed that the same hue was manifested to *prussiate of potash* when pure *barytes* was dissolved in distilled water. These experiments were renewed in the presence of several persons, but always with the same negative results. Upon the addition of *sulphuric acid* a precipitation took place of the *sulphate of barytes*. Hence it is proved that the *metallic* lustre exhibited by the *barytes* cannot be owing either to *iron* or to *zinc* used in the preparation of the *hydrogen gas* necessary for effecting its fusion; because the most minute portions of these metals would have been detected by the re-agents here mentioned.

Having thus replied, and I hope satisfactorily, to the observations made by Dr. Paris, I will now conclude this letter by noticing a few other experiments which may contribute to the amusement of your readers:—

EXPER. I. *Corundum*.—If during the fusion of this substance it be allowed to fall, while hot, upon a deal board, it will become

coated over with a film of carbon, exhibiting the highest *pseudo-metallic* lustre, which however disappears upon the action of the file. The same happens in the fusion of *rock crystal*, of pure *alumina*, *magnesia*, and many other refractory bodies. The appearance of this *pseudo-metallic* lustre might deceive any person; but it is distinguished from *reguline* lustre in this circumstance, that the file removes it.

EXPER. II. *Crystallized Phosphate of Lime, found near Bovey in Devonshire*.—No decrepitation. Phosphorescence. Fuses into a black shining slag; depositing on iron forceps a cupreous-coloured powder. Scintillation—reddish coloured flame. Upon filing the slag we observed a globule of white metal, resembling silver, which does not alter by exposure to air.

EXPER. III. *Crystals deposited during the Fusion of Wood Tin*—In many recent experiments for the reduction of *wood tin* to the metallic state, when fused, *per se*, before the ignited gas, we have observed a deposit of white shining vitreous crystals in quadrangular tables, the nature of which has not been ascertained. These crystals are formed upon the *white oxide* which results from the combustion of the metal.

EXPER. IV.—*Hydrogen gas* prepared by the action of *zinc* on *water* with *muratic acid*, when condensed alone in the reservoir of the *gas blow-pipe*, and ignited, was found to have heat enough for the fusion of *platinum* foil, and for the combustion of *iron wire*.

EXPER. V. *Protoxide of Chromium*.—Mixed with oil it was easily fused, and white fumes were disengaged, but the metal did not appear to be revived by this process.

EXPER. VI. *Metalloidal Oxide of Manganese*.—Admitted of easy fusion. Afterwards the file disclosed a metal white as silver, on which the teeth of the instrument were visible. This metal proved to be a conductor of electricity.

EXPER. VII. *Alloy of Platinum and Gold*.—When fused in equal parts by bulk, a bead was obtained so highly malleable that it was extended by a hammer without separation at the edges. Colour nearly the same as gold. When two parts of *platinum** were fused with one of *gold*, the alloy proved brittle.

I remain, Sir, yours, &c.

Cambridge, July 19, 1817.

EDWARD DANIEL CLARKE.

* In all experiments where *platinum* is fused before the ignited gas, a vivid scintillation may be observed, like that exhibited by *iron wire* during its combustion: but it has not yet been ascertained whether this scintillation be owing to the dispersion of minute globules of the *platinum* in a state of ebullition; or to the combustion of the metal; or of any impurities it may contain. It takes place after repeated fusion.

ARTICLE XII.

Proceedings of Philosophical Societies.

ROYAL SOCIETY.

On Thursday, June 26, the following papers were read:—

Some Account of the Nests of the Java Swallow, and of the Glands that secrete the Mucus of which they are composed. By Sir Everard Home, Bart.

Observations on the *Hirudo Complanata* and the *Hirudo Stagnalis*, now formed into a distinct Genus, under the name of *Glossiphonia*, by Dr. J. R. Johnson. Communicated by Sir Everard Home, Bart.

Account of the Cure of a diseased Foot, arising from an Injury to the Coffin Bone. By Wm. Sewell, Esq. Communicated by the President.

On the Parallax of the fixed Stars. By John Pond, Esq. Astronomer Royal. Mr. Pond found that when his observations were made with the precautions indicated in a former paper, there was no evidence whatever of any parallax in the stars examined.

Observations on the Gastric Glands of the Human Stomach, and the Contraction which takes place in that Viscus. By Sir Everard Home, Bart.

The Society adjourned during the interval of the long vacation.

GEOLOGICAL SOCIETY.

May 16, 1817.—A paper by Dr. Berger, entitled, Note on the Specific Gravity and Temperature of Sea Water in different Places, was read.

The temperature and degree of softness of sea water are considered by the author as circumstances of considerable importance to geologists, and he has communicated to the Society, in the form of a table, such observations as he has been able to make.

The mean of five experiments on the water of the Irish Sea and the North Sea gives a specific gravity of 1.01875, which is less than the results given in Kirwan's table.

The mean temperature, according to the observations which were taken at various times, both of the day and of the year, is—

Of the sea water of the surface	57.07 Fahr.
Of the atmosphere in the shade	55.87
Ditto in the sun	62.90

In passing over from Dublin to Holyhead, on Dec. 27, 1812, the observations made were as follows:—

	Air in shade.	Sea at surface.
At $\frac{1}{4}$ before ten, a. m. six miles from Howth	44	46 $\frac{1}{2}$
Noon, seven leagues from Howth	50 $\frac{1}{2}$	44 $\frac{1}{4}$ *
Two o'clock, p. m. 12 or 14 leagues from Howth	45 $\frac{1}{2}$	50 \dagger
Four o'clock, six or seven leagues from Holyhead		
	45 $\frac{1}{2}$	53 \dagger

The author considers that these circumstances confirm an idea formerly entertained, that the agitation of the sea by a storm increases its temperature.

Dr. Berger has also given a table of the temperature at the surface of several lakes in the North of Ireland, of which the mean is, that of the air in the shade being 58.352, that of the water at the surface was 59.224. These results accord with those of Dr. Irving's observations made in the North Sea, and of Dr. Wollaston's on the River Thames, in showing the temperature of the water at the surface to be above that of the atmosphere; but in Dr. Wollaston's experiments the difference is more considerable.

June 6.—Mr. Bigge's paper was read, entitled, *Observations on the Cheviot Hills and the North-Western Boundary of Northumberland.*

The chain of hills extending from Thirlemoor, near the head of the Coquet, to the plain on the south side of the Tweed, is composed chiefly of porphyry and syenite of various modifications. In several parts large craggy rocks, having the appearance of cairns, arise above the surface. These are composed principally of whinstone or petrosiliceous porphyry with hornblende; but Mr. Bigge has not in any instance been able to observe their junction with the main rock.

The Coquet and the Bremish rivers rise in these hills, and the author traces their courses as a guide to future inquirers. The course of the Coquet is at the extreme point of the porphyritic range to the south. It passes over a considerable extent of slate, rising to the NNE, though nearly vertical, and curved in some places.

Further on its bed is porphyry, interrupted in some instances by whinstone dykes. At Limshiels the porphyry is succeeded by a shistose lime-stone dipping SSW, and alternating with a coarse sand-stone, and the river continues its course to the sea through various beds of lime-stone and sand-stone, but which meet with an interruption from a whin dyke at Brainsaugh, below Felton.

The Bremish rises on the south side of Cheviot, and passes for several miles between high hills of porphyry. On the summit of one of them, Shilmoor, the author observed a vein of quartz traversing the hill from SE to NW. At Branton the river quits the porphyry, and passes along a plain of sand with hillocks of gravel.

* Wind NW. † The wind having greatly increased. ‡ Wind still higher.

Turning to the north, it soon afterwards takes the name of the Till, and passes into the Tweed through beds of sand-stone, having on the east beds of lime-stone and coal. At Roddam Dean a bed of sand-stone occurs covered with a coarse breccia.

Blocks of granite, of a grey colour and fine grain, are found in the hillocks on the plain of Bewick.

June 20. *Concluding Meeting.*—The following communications were received since the last meeting:—

Observations on certain Sand-stones. By A. Aikin, Esq.

Notice on the Physical Constitution of the Passage of Mount St. Gothard. By Dr. Berger.

Account of the Place where some Specimens presented to the Society by Mr. Swedenstierna were found. By S. Solly, Esq.

Sweden does not present that appearance of regular stratification which is observable in this country. Its face is covered with crags and fragments; but some of the larger basins into which its surface is indented contain insulated series of horizontal strata. Many ridges of granite gravel running from north to south cover its surface. In one of these ridges near Finbo a quarry was opened by M. Gahn; jun. and in the subjacent rock the pyrophyllite was first discovered, and subsequently various other new and rare minerals. The rock in which these substances are found has the character of a large grained granite.

ROYAL ACADEMY OF SCIENCES.

Analysis of the Labours of the Royal Academy of Sciences of the Institute of France during the Year 1816.

PHYSICAL PART.—By M. le Chevalier Cuvier, Perpetual Secretary.

(Continued from vol. ix. p. 479.)

MINERALOGY AND GEOLOGY.

Greenland furnished some years ago a mineral in small dodecahedral crystals of a celadon-green colour, to which the name of *sodalite* has been given, because it contains nearly the fourth of its weight of soda united to silica and alumina.

M. Count Dunin Barkowskig, a Gallician gentleman, and a zealous and well-informed mineralogist, has discovered a colourless variety of this stone in large prisms in that part of Vesuvius called Fosso Grande, so celebrated for the number and variety of minerals which it has given to collectors. The composition of this mineral, very similar to that of glass, might have appeared striking among crystals thrown out of a volcano, if it were not accompanied by a number of other species which have nothing in common with glass, and if the sodalites of Greenland did not occur in a place which exhibits no traces of subterraneous fires.

Geology, in the scientific form to which it has been lately elevated

vated, has less for its object to invent, as formerly, systems respecting the states through which the globe has passed, than to describe exactly its actual state, and the relative position of the minerals which constitute its surface. It is known that in this point of view these masses have been divided into *primitive*, or those which exhibit no traces of organized beings, and which are considered anterior to the existence of animals; and into *secondary*, which are all more or less filled with the remains of these bodies, and which consequently must have been formed after the existence of animals. These masses are, besides, generally different in their nature, and in the substances of which they are composed. It was even long believed that these bodies succeeded each other in a very regular manner, so that none of those deposited before the existence of organized beings were deposited afterwards, and *vice versa*.

But this was a premature assertion, which has been overturned by more observations. It has been observed that among these two kinds of deposits there exist mixtures, so that ancient formations are reproduced after more modern rocks have shown themselves; and some organized bodies are covered by masses of the same nature as those which were believed to have ceased to be deposited after the appearance of animals upon the globe. These monuments of the passage from one state of things to another have been called *transition formations*.

It is not always easy to recognise them for such; and M. Brochant, in a memoir published some time ago, required all his sagacity to assign to this intermediate class the greatest part of the rocks in the valley of Tarentaise; especially as at that time certain shells had not been discovered, whose existence in these rocks has confirmed, in the most flattering manner, the conjectures and reasonings of this skilful geologist.

He has since extended this kind of research, and has, during the present year, directed them principally to the old beds of gypsum, found in abundance in certain parts of the Alps, enormous masses of which must be perceived by all the travellers who pass over Mount Cenis. After describing, with the utmost exactness, all the circumstances relative to their position, and after having frequently gone round the mountains on the sides of which they appear, the author shows that their situation and their nature correspond with those of transition rocks, and proves that they must be arranged in that class.

The primitive formations themselves are not always easily characterized. The irregularity of their position, the immense space through which it is sometimes necessary to trace them, and the many variations in their composition, present great difficulties. Thus M. Brochant has ascertained, by long journeys and fatiguing examinations, that the high points of the Alps, from Mount Cenis to St. Gothard, and particularly Mont Blanc, are not, as has been generally believed, granite properly so called, but belong to a variety more crystalline, and more abounding in felspar, of a talky

and felspathic rock, which predominates in a very considerable proportion of the Alps, and which often contains metallic minerals in beds. He satisfied himself, at the same time, that a true granite formation exists on the south side of the chain; and from analogy he considers it as very probable that this granitic formation supports the talky rock. From which he concludes that the high summits of the Alps are not the portion relatively most ancient of these mountains.

We gave an account at the time of a very analogous arrangement discovered in the Pyrenees by M. Ramond.

We ought always to remark that the primordiality of granite among known rocks is subject to exceptions. M. Von Buch ascertained that in Norway granites evidently characterized as such lie over rocks considered as more modern, and even over rocks containing petrifications. This has been observed likewise in Saxony and in the Caucasus.

M. de Bonnard, Engineer of Mines in France, who, by a singularity honourable for us, has given to geology the first complete description of the Ertzgebirge, of that province of Saxony, which is in some measure the native country of geology. M. de Bonnard has endeavoured in that work to determine the places where the granite is below the other formations, and those in which it lies over any one. It cannot be doubted, from his examination, that the granite of Dohna is in this latter case, as had been announced by Saxon observers; but in other places, and especially near Freyberg, granite was too hastily concluded to be superior, from some irregularities in the form of the masses, the jutting portions of which frequently make their way through the rocks that cover them. It appears, likewise, that the chain which separates Saxony from Bohemia has likewise granite on its south side.

This memoir of M. de Bonnard contains many other precious details on the nature and position of the formations in the celebrated province which he has studied, and likewise on the rich metallic veins which traverse it in all directions, and on which the industry of the miners has been so long employed. In these respects it is equally interesting for geology and for the art of working mines.

M. Heron de Villefosse, at present a free associate of the Academy, has rendered an essential service to the same art by his work, entitled, *De la Richesse Minerale*. The first volume, which had for its object the administration of mines, was printed in 1810, and has been long known and esteemed. The second, in which he treats of the working of mines, has been presented in manuscript to the Academy. To the directions derived from the numerous sciences which furnish the theory, the author has added an immense number of facts collected in his travels, and in the exercise of his functions; so that the precepts are supported by examples, which have nothing imaginary, but are all realized in some place or other. A magnificent atlas exhibits to the eye all of these examples that can be represented. He gives geological maps of the Hartz

and of Saxony, the countries most celebrated for the antiquity of their mines; plans and sections of all the positions of the ore in the earth, and likewise of the different methods of working it, and every kind of machine employed for that purpose. Almost the whole of these materials are new, and have been collected on the spot by the author. The great utility of such a work, for a country in which the art of which it treats is still in its infancy, cannot be doubted.

The discovery, so important to geology, made by MM. Brongniart and Cuvier, of certain beds which contain only land and fresh water shells, and which of consequence cannot have been formed in the sea, like other beds containing shells, has excited numerous researches all over Europe. We gave an account at the time of those of MM. Marcel de Serres and Daubert de Ferussac on fresh water beds in different parts of France, Spain, and Germany. Similar and very extensive discoveries have been made in England. This year M. Beudant, Professor at Marseilles, has considered this matter under a new point of view. As we find in some places fresh water shells mixed with sea shells, he endeavoured to discover by experiment how far the molusca of fresh water can be habituated to sea water, and *vice versa*. He found that all these animals die immediately if we suddenly change their place of abode; but that if we gradually increase the proportion of salt in the water for the one set, and diminish it for the other set, we can in general accustom them to live in a water which is not natural to them. There are some species, however, which resist these attempts, and which cannot bear any alteration in the quality of the water which they inhabit.

Nature pointed out these results beforehand. Certain oysters, certain cerites, the common muscle, proceed pretty high up in rivers; and we see some limneas in places where the water is a good deal mixed with sea water.

M. Marcel de Serres has continued his former researches on fresh water beds, of which we gave an account in our analysis for 1813. He has directed his principal attention this year to a formation of this kind, which he considers as newer than all the others, and which he discovered in seven different places in the environs of Montpellier. His observations are in some measure connected with those of M. Beudant. He distinguishes the species in the neighbourhood of Montpellier into those that do not appear capable of living except in fresh water; those which can exist in brackish water, of which the maximum is 2.75° ; and those to which sea water appears necessary. He explains in this way some very rare mixtures of the remains of these animals.

The formation which he describes is composed in some measure of two beds containing different shells. The upper one contains land shells at the same time with aquatic shells. The new formation is laid upon the surface of different formations, and chiefly

upon the sides of hills or platforms. We see there many land shells and vegetable impressions perfectly similar to the species living at present upon the same soil.

In proportion as we advance in Europe in geological observations, there are zealous individuals who apply them to remote countries, and who find nature faithful to the same laws.

We have spoken several times of the immense labours of Humboldt on the structure and elevation of the mountains of the two Americas. This philosophic traveller appears to have given a prelude to labours no less important by a general view of the results obtained in India respecting the height of different peaks of that immense chain known to the ancients by the name of Imaus, and where the Hindoos have placed the principal facts of their mythology.

From the trigonometrical measurements of Mr. Webb, an English engineer, four of these peaks are more elevated than Chimborasso; and one of them, the highest mountain at present known on the globe, is 4013 toises or 7821 metres in height, or according to other calculations 4201 toises, or 8187 metres.

M. de Humboldt in this memoir has made a happy use of the laws of vegetable geography, to supply information respecting the height of certain platforms which it has not been possible hitherto to ascertain directly. When such or such a plant is cultivated in a place he determines according to the latitude what height the platform in which the plant occurs cannot exceed. This will be a curious subject of verification for travellers, who, from the numerous relations established with them, will now go in greater numbers to visit these valleys and these mountains of Imaus, Thibet, Boutan, and Nepaul, countries probably the most interesting of all for the history of mankind, since every thing announces that it was from them that our race originally descended.

In a more limited space, M. Moreau de Jonnés, named lately a correspondent of the Academy, has not failed to make useful observations. He has presented to the Academy a geological map of part of Martinique, in which the height of the different mountains is marked with great care, especially of the extinct volcano which seems to have produced most of those inequalities.

The author has extended his researches to the geology of a great part of the Antilles. Volcanic peaks occupy the elevated centres of these islands, and are called *mornes*. The beds of lava which have flowed from them are called *barres*, and the plains formed at their lower parts are distinguished by the appellation of *plainiers*.

Islands in which only one peak and a single system of eruptions occur, such as Saba, Nieves, St. Vincent, are smaller, and less important for agriculture. They have no good ports, because the harbours are merely the plains left between two or more systems, such as we see at Guadaloupe, Martinique, Dominica, St. Lucie, Grenada, &c. Martinique in particular seems to owe its origin to six volcanoes, and shows at present six peaks, to which the whole of it may be referred.

M. de Jonnés gives us the exact topography and mineralogy of one of these; namely, Mount Pelée. He considers this volcanic nature as so general that he conceives it serves as a base to the whole Antilles, which exhibit superficially only lime-stone obviously containing shells, such as La Barbade and the larger portion of Guadeloupe. Guadeloupe properly so called is formed of four systems of eruption, one of which, the *Soufriere*, still retains some activity. M. de Jonnés likewise gives a description of it in a general statistical account of this island.

(To be continued.)

ARTICLE XIII.

SCIENTIFIC INTELLIGENCE; AND NOTICES OF SUBJECTS CONNECTED WITH SCIENCE.

I. *A Descending Spout on Land.* By Luke Howard, Esq.

On the 27th of the sixth month, at about seven in the evening, there occurred in our neighbourhood an undoubted exhibition of that rare spectacle (to observers on land)—the *water-spout*. I shall give the observations of two of our workmen at the Laboratory who saw it from Stratford, passing on their N horizon from NW to NE. I was absent myself in the West of England; but my friend John Gibson witnessed the latter part of the phenomenon.

The clouds had been exceedingly dark and threatening, and there had been thunder and rain in that direction; but at the time of the observation a clear sky was discernible beneath the clouds. From a dense cloud, the base of which might be at an elevation of 20° , there issued suddenly a *descending cone*, which one of the observers compared to a steeple inverted: this returned back to the cloud: a second and a third followed, one of which came lower, with a considerable *perpendicular oscillation*, and at length opened out below; and a *straight column*, which he compared to a dart, proceeded from its enlarged extremity to the earth, being visible also as a *denser body* pretty far up into the cloud. In a little time this cone also, losing its appendage, was drawn up again, and another or two, similar to the first mentioned, succeeding, closed the train of appearances, the whole having lasted about 15 minutes.

The course of this spout appears to have been over the country about Hampstead. In a communication, by another observer, to the *Philanthropic Gazette*, a person states himself to have been overtaken by it on Hampstead Heath, and to have been drenched by a fall of rain in very unusual torrents during its short passage. He conceived the spout to touch the top of the tree under which he had retired for shelter. The denser column seen by the observer at Stratford to proceed from the cloud admits of an explanation

when connected with this fact. It was probably an extremely dense shower, or rather *stream of water* (of small diameter compared with showers as they usually fall) generated in the axis of the cone of cloud by the strong electrical action, and serving ultimately as a conductor, through which the electricity rushed at once, and the equilibrium was so far restored as that a second discharge could not be effected. Had it been at sea, the tendency of the superinduced moveable surface to unite with the cloud would probably have raised up a column of salt water to meet it.

Tottenham, Seventh Month, 21, 1817.

LUKE HOWARD.

II. Gum from the Congo.

The gentlemen constituting the unfortunate expedition to the Congo, while walking along the banks of this river, picked up a large mass of gum, on which I had an opportunity of making a few experiments. It was of a dark brown colour, and only slightly translucent. It was very hard; and had very much the aspect of the cherry-tree gum of this country after it has been exposed for some years to the action of the weather.

When this gum was put into water, the liquid acquired a dark colour. But none of the gum was dissolved; for the liquid was not in the least mucilaginous, and could not be employed to paste together pieces of paper. When evaporated to dryness, it left a black matter, nearly tasteless, soluble again in water, and possessing the characters of extractive.

The gum still retained its dark colour. It swelled very much in the water, and was converted into a semitransparent jelly. But it did not dissolve, even when the water was boiled. But on the addition of a little muriatic or nitric acid a transparent solution was effected. When an alkali was dropped into this solution, the gummy matter was again precipitated.

These properties are sufficient to show us that the gummy substance in question possesses the chemical characters of the vegetable principle called *cerasin*.

It has been long known that there are two distinct species of *gum*: one, which dissolves in cold water; another species, which is insoluble in water, but forms with it a jelly, and dissolves readily in water acidulated with any of the mineral acids. Gum arabic constitutes a well-known example of the first kind; and gum tragacanth has been long known as a very perfect example of the second. The term *gum* has been reserved of late by chemists to denote the first species, or what was formerly called *soluble gum*. Dr. John has applied to the second species the term *cerasin*, because the cherry-tree gum contains a considerable quantity of this matter, which is insoluble in pure water, and but forms a jelly with that liquid, and dissolves readily in water acidulated with the mineral acids. *Tragacanth* would have been a better name; but I am deterred from adopting it by the consideration that this substance is usually deno-

minated adraganth on the continent; and this double name might perhaps occasion ambiguity. I suspect the gum bassora of Vauquelin, in which he some years ago recognised the properties of cerasin, is a variety of tragacanth. It possesses at least all its characters.

III. Disappearance of Saturn's Ring.

(To Dr. Thomson.)

SIR,

The disappearance of Saturn's ring will take place in the year 1819; and it is so curious an occurrence, that I was desirous of knowing at what time it might be expected: I therefore had recourse to Delambre's method (*Astronomie*, vol. iii. ch. xxix.), and I calculate that the plane of the ring will pass through the sun's centre on March 11, and through the earth's centre on the following day (March 12). These two epochs are so very near that there can be no intermediate reappearance of the ring, and their nearness is unfortunately occasioned by the planet's being at the time in conjunction with the sun, which will render all attempts at observation perfectly useless. I would not offer you this calculation if I imagined that there were any error in it; but I was so much disappointed at the result of it, that I cannot help expressing a wish that some of your correspondents would repeat it: I do not like to think on the long interval which must, as it seems, yet elapse before we shall have an opportunity of seeing this remarkable phenomenon.

S.

IV. Deuto-sulphuret of Copper.

Dobereiner affirms that when a current of sulphureted hydrogen gas is passed through a solution of copper in an acid, a black precipitate falls, which, when dried, has a dark bluish green colour. He affirms that it is a compound of two parts by weight of copper and one part of sulphur. Hence it is obvious that it is a compound of 1 atom copper + 2 atoms sulphur; for an atom of copper weighs 8, and an atom of sulphur 2. Therefore we have

$$1 \text{ atom copper} = 8 \text{ or } 2$$

$$2 \text{ atoms sulphur} = 4 \text{ or } 1$$

Dobereiner further affirms that when a solution of peroxide of copper is boiled with an alkaline hydro-sulphuret, a precipitate falls, which, when dried, has a dark flame-yellow colour. This precipitate, he says, is composed of equal weights of sulphur and copper. If this statement be correct, it is a compound of 1 atom copper + 4 atoms sulphur; so that there are three sulphurets of copper:—

1. Proto-sulphuret, composed of 1 atom copper + 1 atom sulphur.
2. Deuto-sulphuret 1 + 2
3. Persulphuret 1 + 4

(See Schweigger's Journal, xvii. p. 414.)

V. *Hydrates of Tin.*

The peroxide of tin is well known to chemists to be a yellow-tasteless powder, composed of

Tin	7·375
Oxygen	2·000

When this oxide is obtained by digesting tin in diluted nitric acid, a fine white matter remains, which may be obtained in a separate state, by washing it well with water, and then throwing it on the filter. When dried in a heat of about 130°, it forms a white, semi-transparent, friable hydrate, having a vitreous fracture, composed of one atom peroxide of tin and two atoms water; or, by weight, of

Peroxide of tin	80·64	or	100
Water	19·36		24

100·00

By drying it in the open air without the application of any artificial heat, I have obtained a hydrate containing twice as much water as the preceding. It is remarkable for the beauty of its white colour, and for a silky lustre, which renders it exceedingly pleasing to the eye. It was composed of one atom peroxide of tin and four atoms water, or of

Peroxide of tin	100
Water	48

These are the only combinations of peroxide of tin and water which I have been able to obtain. I did not succeed in forming a hydrate composed of one atom peroxide of tin and one atom water, nor of one atom peroxide and three atoms water; though I think there can be little doubt that such combinations are possible.

VI. *Butter of Antimony.*

What was formerly called butter of antimony is now known to be a compound of 1 atom antimony + 1 atom chlorine. It is, therefore, a *chloride of antimony*. Proust showed that it might be made directly by dissolving antimony in a mixture of one part nitric acid and four parts muriatic acid, evaporating to dryness, and then distilling the residuum. The butter of antimony comes over into the receiver. M. Robiquet has published some circumstances relative to this process that deserve the attention of the practical chemist. When the solution goes on slowly, the theory of it, according to the present opinions of chemists, is as follows:—The nitric acid deprives the muriatic acid of its hydrogen, and converts it into chlorine; and the chlorine, as it evolves, unites with the antimony, and converts it into chloride. But the formation of chlorine goes on after the whole of the metal is dissolved. This chlorine remains in the liquid, and is not separated even when the mixture is evaporated to the consistency of a syrup. The consequence is, that pure

butter of antimony is not obtained. To obviate this inconvenience, it is only necessary to put the concentrated solution into a flagon, and to agitate it with antimony in powder. This antimony dissolves rapidly, uniting with the excess of chlorine, and forming an additional quantity of chloride. The antimony must be added cautiously; for it dissolves so rapidly that, if its quantity be considerable, so much heat is evolved that the vessel is in danger of being broken.

When the solution goes on rapidly, if we evaporate after it is over, a precipitate falls, and the evolution of nitrous gas is so great that the evaporation cannot be continued. The reason is, that the chloride has been dissipated by the heat. Hence the excess of nitric acid present acts upon the chloride, converts it partly into oxide, and occasions the precipitation. To remedy this inconvenience, we have only to add a portion of muriatic acid before we begin to evaporate. (See *Ann. de Chim. et Phys.* iv. 165.)

VII. *Emetin.*

This is a name given by MM. Magendie and Pelletier to a peculiar principle which they extracted from ipecacuanha, to which that root is indebted for the emetic properties which it possesses.

Emetin may be obtained by the following process:—Digest powdered ipecacuanha in alcohol. Evaporate the alcohol to dryness. Digest the residue in water; filter, and evaporate the aqueous solution to dryness. The yellowish red matter thus obtained is emetin in a state of tolerable purity. If, instead of evaporating the aqueous solution to dryness, it be mixed with acetate of lead, the emetin precipitates in combination with the oxide of lead. Let this precipitate, after being welledulcorated, be diffused through water, and a current of sulphureted hydrogen gas passed through it, the lead is precipitated in the state of a sulphuret, and the emetin dissolves in the water. When this solution is filtered, and evaporated to dryness, the residue obtained is pure emetin.

Emetin thus obtained is in transparent scales, of a brownish red colour. It has no smell. Its taste is bitter, and a little acrid, but not in the least nauseous. It is not altered by exposure to any degree of heat inferior to that of boiling water. When exposed to a stronger heat, it does not melt, but swells, blackens, and is decomposed, furnishing water, carbonic acid, a small quantity of oil, and acetic acid. A very spongy and light coal remains. No ammonia can be discovered in the products, indicating that azote does not enter into the composition of emetin.

When exposed to the air, it undergoes no change, unless the air be very moist, in which case it becomes somewhat liquid. It dissolves very readily in water. It cannot be made to crystallize. It is soluble in alcohol, but insoluble in sulphuric ether.

Diluted sulphuric acid produces no effect upon it; concentrated sulphuric acid chars and destroys it. Nitric acid dissolves it, either cold or hot, and forms a fine red-coloured solution. This colour

gradually passes to yellow, nitrous vapours are exhaled, and crystals of oxalic acid formed, but no yellow bitter principle. Muriatic and phosphoric acids dissolve it without alteration, and let it fall again when they are saturated with an alkali. Acetic acid is one of the best solvents of emetin. Gallic acid, on the contrary, throws it down from its solution in water or alcohol, forming with it a dirty white compound.

The alkalis dissolve the compound of emetin and gallic acid. When iodine is poured into the tincture of emetin, a red precipitate falls, which is a compound of emetin and iodine.

Proto-nitrate of mercury has at first no action on solution of emetin, but after some time it produces a slight precipitate. Corrosive sublimate occasions rather a more abundant precipitate. Tartar emetic has no action on it whatever.

Gum, sugar, gelatine, and all other animal and vegetable substances tried, have no action whatever on emetin.

Half a grain of emetin produces vomiting, followed by sleep, and the animal awakes in perfect health. Six grains of emetin occasion vomiting and sleep, followed by death. A violent inflammation of the lungs and intestinal canal appears to be the cause of the fatal effects of a considerable dose of this substance. (See Ann. de Chim. et Phys. iv. 172.)

VIII. *Insects living in a Vacuum.*

M. Biot has observed that the insects called by the French *blaps* and *tenebrions* may be left in the best vacuum that can be made by an air-pump for days without their appearing to suffer any inconvenience.

IX. *New Method of detecting Arsenious Acid, or Corrosive Sublimate, when in Solution.*

Take a little recent wheat starch; add to it a sufficient quantity of iodine to give it a blue colour. Mix a little of this blue matter with water, so as to have a blue-coloured liquid. If into this liquid a few drops of an aqueous solution of arsenious acid be put, the blue colour is immediately changed to reddish-brown, and is gradually dissipated entirely. The solution of corrosive sublimate produces nearly the same effect; but if some drops of sulphuric acid be added, the blue colour is again restored if it has been destroyed by arsenious acid; but if it has been destroyed by corrosive sublimate, it is not restored, either by sulphuric acid, or by any other acid. (Brugnatelli, Ann. de Chim. et Phys. iv. 334.)

X. *Arragonite.*

It will be recollected that, after the discovery of carbonate of strontian by Stromeyer in arragonite, Messrs. Bucholz and Meissner analyzed twelve specimens from different places; that they found strontian in seven of the twelve; but could detect none in the remaining five. Among these five was the arragonite of Bastènes,

which, according to these chemists, contained nothing but carbonate of lime and a little sulphate of lime. Laugier has lately examined a specimen of arragonite from the same place. He found in it traces of carbonate of strontian, though the quantity of that substance present did not exceed the thousandth part of the weight of the specimen. In two other specimens of arragonite, one from Baudissero, near Turin, the other from the country of Gex, he could detect no strontian whatever; but he remarks that these specimens did not exhibit all the characters of arragonite. That of Baudissero, though pretty regularly crystallized, was opaque, and very friable. That from Gex has the vitreous fracture, and the hardness of the best characterized arragonites; but it is massive, and exhibits no appearance of crystallization. In general the purest, most transparent, and most regularly crystallized arragonites, are those which contain the greatest quantity of strontian; while those which are impure, and mixed with sulphate of lime, either contain none, or very little of that substance. (Ann. de Chim. et Phys. iv. 361.)

XI. *New Analysis of the Meteoric Iron of Siberia.*

M. Laugier has lately subjected a specimen of this well-known mass of iron to analysis. He found its constituents as follows:—

Oxide of iron	68·2
Silica	16
Magnesia	15
Sulphur	5·2
Nickel	5·2
Chromium	0·5
Loss	3

113·1

The increase of weight is owing to the oxidizement of the metals. This analysis shows us that the constituents of this iron are quite the same as those of the meteoric stones. (See Ann. de Chim. et Phys. iv. 363.)

XII. *Serpent found in Devonshire.*

I have been informed by Dr. Leach that the *red viper* described by Mr. Rackett in a paper read to the Linnæan Society on April 15, is no more than a very common variety of the young viper of Britain. He also says that *coluber cæruleus* of the Linnæan Transactions, *col. prester* and *chersea* of Linnæus, are also varieties of the same species, viz. of *vipera berus*.

XIII. *Translator of Euler's Algebra.*

(To Dr. Thomson.)

DEAR SIR,

I lose no time in correcting the opinion you have given in your *Annals* for last month respecting the person who translated Euler's

Algebra. The translator, I am pretty sure, is Mr. P. Barlow, of Woolwich, the author of a respectable Treatise on the Theory of Numbers, and of one or two other mathematical works. If I were at home, and among my books, I could speak more decisively on this point, as I think the fact is stated in the preface to the work I have named; and if not, the identity of several passages with the notes by the translator of Euler affords internal demonstration of Mr. B.'s claim to the honour of having introduced the excellent treatise in question to English readers.

As to myself, the fact is, that I have never appeared before the public as an author, except of detached communications to reputable periodicals; having been deterred from such an enterprise partly by the insufficiency of the intervals of leisure I enjoy for producing a continuous work, and partly by some examples which have fallen too closely under my observation to leave any doubt of the hazardous nature of a mathematical adventure in England; my friends say, by modesty too—*sed non ego credulus illis*—and are not the reasons I have given quite sufficient?

With every sentiment of respect and obligation,

I subscribe myself yours most sincerely,

W. G. HORNER.

XIV. Death of Mr. Gregor.

The county of Cornwall has suffered an irreparable loss by the death of the Rev. Wm. Gregor, of Creed, who died about the end of June of a consumption. He is universally known as the discoverer of titanium; and was in every point of view one of the most accurate and sagacious chemical analysts of his day. I expect in the course of a number or two to be able to lay before the public a biographical account of this celebrated man, which a scientific friend of mine in Cornwall, to whom Mr. Gregor bequeathed his papers, has kindly promised to draw up.

XV. Morphium.

The existence and properties of morphium, of which I gave a sketch in a late number of the *Annals of Philosophy*, have been ascertained, and all the leading facts corroborated, by several skilful chemists, both in this country and in Paris. There cannot, therefore, be longer any doubt that it is in reality entitled to rank as a new vegetable combustible alkali. It will be necessary to change the name to *morphia*, to make its termination agree with that of the other alkalies. The discovery of this new compound alkali destroys Berzelius's reasoning respecting the metallic nature of the basis of ammonia. The great strength of his argument lay in this: every other base capable of saturating acids contains oxygen. Therefore it is reasonable to conclude that ammonia contains it.

ARTICLE XIV.

New Patents.

SAMUEL BROWN, of Mark-lane, London, Captain in the Royal Navy, and PHILIP THOMAS, of Liverpool, manufacturer of iron cables; for a chain or chains, manufactured in a peculiar way, by a new process or processes, and certain apparatus and improvements in performing and executing the same. Dec. 19, 1816.

WILLIAM MANTON, of South-street, Grosvenor-square; for a certain improvement in the application of springs to wheel carriages. Jan. 2, 1817.

JOHN RAFFIELD, of Edward-street, Portman-square, architect; for certain improvements on, and additions to, his former patent, for an apparatus to be attached to fire-stoves, for rooms, for the removal of cinders and ashes, and for the better prevention of dust arising therefrom; which additions may be used jointly or separately. Jan. 10, 1817.

DANIEL WILSON, of Dublin, Gentleman; for improvements in the process of boiling and refining sugar. Jan. 23, 1817.

ROBERT DICKINSON, Esq. of Great Queen-street, Lincoln's Inn-fields; for a method or methods of preparing or paving streets and roads for horses and carriages, so as to render the parts or pavements when so done more durable, and ultimately less expensive, than those in common use, and presenting other important advantages. Jan. 23, 1817.

JOSEPH DE CAVAILLON, of Sambrook-court, Basinghall-street, Gentleman; for improvements in the preparing, clarifying, and refining of sugar, and other vegetable, animal, and mineral substances, and in the machinery and utensils used therein. Jan. 23, 1817.

WILLIAM WALL, watchmaker, of Wandsworth, Surrey; for an horizontal escapement for watches. Feb. 1, 1817.

GEORGE MONTAGUE HIGGINSON, Lieutenant in the Navy, of Boverly Tracy, Chudleigh, Devonshire; for improvements in locks. Feb. 1, 1817.

ISAAC ROBERT MOTT, composer and teacher of music, at Brighton; for a method of producing from vibrating substances a tone, or musical sound, the peculiar powers in the management whereof are entirely new, and which musical instrument he denominates the *Sostimente Piano-forte*. Feb. 1, 1817.

WILLIAM BUNDY, of Pratt-place, Camden Town, mathematical instrument-maker; for machinery for breaking and preparing flax and hemp. Feb. 1, 1817.

JAMES ATKINSON, Fleet-street, brass-worker and lamp-manufacturer; for improvements in or on lustres, chandeliers, lanthorns, and lamps, of various descriptions, and in the manner of conveying the gas to the same. Feb. 6, 1817.

WILLIAM CLARK, Esq. of Bath; for a contrivance, to be called a safeguard to locks, applicable to locks in general, by which they may be so secured as to defy the attempts of plunderers using pick-locks or false keys. Feb. 9, 1817.

ARTICLE XV.

Scientific Books in hand, or in the Press.

Mr. Accum has in the press *Chemical Amusement*; comprising a series of curious and instructive experiments in chemistry, which are easily performed, and unattended by danger.

The new edition of Dr. Thomson's *System of Chemistry* will be ready for publication by the first of October.

Mr. Fred. Schlegel's *Lectures on the History of Ancient and Modern Literature*, with Notes and an Introduction by the Translator, in two volumes, 8vo. will soon appear.

A volume of *Transactions of the Philosophical Society of London* is in the press.

A Treatise on *Geognosy and Mineralogical Geography*, with numerous Plates, illustrative of the Mineralogical Structure of the Earth in general, and that of Great Britain and other Countries in particular, by Professor Jameson, in two volumes, 8vo. is preparing for publication.

Sir W. Adams has in the press, in one volume, 8vo. a *Practical Inquiry into the Causes of the frequent Failure of the Operation of Extracting and Depressing the Cataract, and the Description of a new and improved Series of Operations*, by the Practice of which most of these Causes of Failure may be avoided. Illustrated by Tables of the comparative Success of the Old and New Operation.

The Second Part of Lackington and Co.'s Catalogue is in the Press, containing the classes—Curious and Rare Books, Poetry and the Drama, the Fine Arts, Natural History, Mathematics, Medicine, &c. &c.

The Third Part of Lackington and Co.'s Catalogue is also in the Press, and will comprise—Classics and Books in all other Foreign Languages.

Ormerod's *History of Cheshire*, Part IV. is just published.

In the press the Report from the Committee of the Honourable the House of Commons on the Employment of Boys in Sweeping of Chimneys, together with the Minutes of the Evidence taken before the Committee, and an Appendix.

Dr. Bancroft has in the press a *Sequel to his Essay on Yellow Fever*.

Mr. James Moore has in the press the *History of Vaccination*.

Mr. Thomas Whately has in the press the Second Edition, corrected and enlarged, of *Practical Observations on the Cure of the Gonorrhœa Virulenta in Men*.

ARTICLE XVI.

Astronomical, Magnetical, and Meteorological Observations.
By Col. Beaufoy, F. R. S.

Bushey Heath, near Stanmore.

Latitude $51^{\circ} 37' 42''$ North. Longitude west in time $1^{\circ} 20' 7''$.

Astronomical Observations.

June 18, emersion of Jupiter's first satellite, mean time at Bushey, $11^{\text{h}} 38' 13''$.
Mean time at Greenwich, $11^{\text{h}} 39' 34''$.

Magnetical Observations, 1817. — Variation West.

Month.	Morning Observ.			Noon Observ.			Evening Observ.		
	Hour.	Variation.		Hour.	Variation.		Hour.	Variation.	
June 1	8h 45'	24° 28'	25''	1h 45'	24° 42'	22''	6h 35'	24° 34'	16''
2	8 35	24 29	55	1 40	24 43	20	6 55	24 34	47
3	—	—	—	—	—	—	6 50	24 34	25
4	8 35	24 30	10	1 35	24 41	00	6 55	24 32	56
5	8 35	24 29	17	1 40	24 39	30	6 55	24 33	23
6	8 35	24 32	18	1 40	24 41	59	6 55	24 35	08
7	8 35	24 28	27	1 35	24 41	29	6 55	24 35	16
8	8 35	24 30	54	1 45	24 40	40	6 55	24 33	23
9	8 35	24 32	42	—	—	—	—	—	—
10	8 40	24 33	00	1 40	24 41	46	6 55	24 36	00
11	8 40	24 34	21	1 45	24 38	22	6 55	24 35	17
12	8 40	24 31	30	1 40	24 41	10	6 50	24 32	50
13	8 30	24 30	58	—	—	—	6 55	24 33	16
14	8 35	24 30	38	1 40	24 41	54	6 55	24 32	55
15	8 35	24 29	59	1 35	24 42	09	6 55	24 34	09
16	8 35	24 30	24	—	—	—	—	—	—
17	8 40	24 31	34	1 40	24 42	32	6 55	24 33	34
18	8 40	24 28	30	1 40	24 44	34	6 55	24 33	23
19	8 35	24 27	50	1 35	24 46	22	6 55	24 34	30
20	8 40	24 28	36	1 35	24 44	14	6 55	24 34	30
21	8 35	24 35	31	1 35	24 44	48	6 55	24 34	17
22	8 35	24 31	53	1 35	24 42	06	6 55	24 35	22
23	8 35	24 31	21	1 35	24 42	04	6 55	24 33	47
24	8 35	24 33	03	1 35	24 42	14	6 55	24 35	56
25	8 40	24 34	18	1 35	24 45	17	6 50	24 32	08
26	8 35	24 33	00	1 35	24 43	14	6 55	24 34	38
27	8 35	24 32	14	1 30	24 42	59	—	—	—
28	8 35	24 28	21	1 30	24 42	04	6 55	24 33	14
29	8 35	24 33	35	1 35	24 39	42	6 55	24 32	23
30	8 50	24 30	51	1 35	24 40	34	6 55	24 34	36
Mean for the Month.	8 37	24 31 09		1 37	24 42 14		6 54	24 34 05	

June 13, in the evening, the needle at intervals vibrated $25' 50''$.
During the night it blew hard from the west.—June 21, at eight

clock in the morning, the variation was $24^{\circ} 28' : 35$ minutes
 ter it increased to $24^{\circ} 35' 31''$: in the course of the day several
 ud claps of thunder were heard in the north-west.

Meteorological Table.

Month.	Time.	Barom.	Ther.	Hyg.	Wind.	Velocity.	Weather.	Six's.
		Inches.				Feet.		
1	Morn....	29-335	51 ^o	53 ^o	NW by N		Very fine	41
	Noon....	29-330	60	43	NNW	7-263	Cloudy	60
	Even....	29-330	51	54	W		Showery	44
2	Morn....	29-333	54	56	SW		Fine	59
	Noon....	29-305	58	52	SW	16-107	Fine	46
3	Even....	29-254	51	52	SW		Cloudy	68
	Morn....	—	—	—	—	—	—	44
4	Noon....	—	—	—	—	—	—	61
	Even....	29-273	53	51	SSW		Cloudy	44
5	Morn....	29-058	55	67	SW by W		Cloudy	61
	Noon....	29-263	61	48	WSW	38-475	Fine	44
6	Even....	29-420	53	50	W		Fine	60
	Morn....	29-635	55	59	W		Cloudy	50
7	Noon....	29-655	60	50	SW	17-771	Cloudy	61
	Even....	29-623	54	50	SW by W		Fine	56
8	Morn....	29-574	55	78	WSW		Drizzle	72
	Noon....	29-574	55	53	WSW	13-082	Fine	54
9	Even....	29-570	60	68	W by S		Fine	64
	Morn....	29-505	63	63	SSW		Fine	48
10	Noon....	29-450	69	52	SW by S	12-911	Fine	—
	Even....	29-335	61	49	SW		Fine	54
11	Morn....	29-287	60	59	W by S		Fine	64
	Noon....	29-295	64	43	WSW	18-907	Showery	48
12	Even....	29-363	53	62	W by S		Hard do.	—
	Morn....	29-413	55	77	SW		Sm. rain	54
13	Noon....	—	—	—	—	—	—	60
	Even....	—	—	—	—	—	—	47
14	Morn....	29-300	56	73	W		Cloudy	64
	Noon....	29-375	62	54	WNW	11-766	Fine	52
15	Even....	29-483	56	60	WNW		Fine	58
	Morn....	29-600	56	59	SSW		Very fine	51
16	Noon....	29-600	64	49	WSW	10-315	Fine	—
	Even....	29-545	57	52	SE by E		Fine	52
17	Morn....	29-323	55	80	SSW		Showery	58
	Noon....	29-318	56	79	SSW	18-321	Showery	51
18	Even....	29-302	55	65	SW		Cloudy	—
	Morn....	29-190	54	73	SE		Rain	50
19	Noon....	—	—	—	—	26-719	Hard do.	57
	Even....	28-813	58	65	SW by S		Fine	45
20	Morn....	29-000	54	60	WSW		Fine	58
	Noon....	29-130	57	55	WSW	36-662	Cloudy	46
21	Even....	29-292	54	55	WNW		Fine	—
	Morn....	29-675	53	53	NW		Fine	47
22	Noon....	29-775	57	48	—	9-053	Cloudy	58
	Even....	29-830	55	49	Calm		Cloudy	46
23	Morn....	29-868	56	48	SSW		Fine	—
	Noon....	—	—	—	—	—	—	47
24	Even....	—	—	—	—	—	—	68
	Morn....	29-672	60	49	ESE		Clear	—
25	Noon....	29-580	68	46	ESE	11-555	Very fine	—
	Even....	29-480	60	46	E by N		Clear	—

REMARKS.

Sixth Month.—7. Much *Cirrocumulus*, a. m. in beds at a considerable elevation: in the evening a group of thunder clouds in the S and SE, which passed after a single peal of thunder to the eastward. 8. Windy: light showers, a. m.: heavier rain, p. m. 9. Stormy wet day and night. 10. Showers: *Cumulostratus* at sun-set. 11. Fine morning. 13. Wet, blowing day: stormy night. 14. Much wind and cloud, a. m.: slight shower: evening more settled. 15. Windy at NW, a. m.: *Cumulus*, with *Cirrostratus*: *Cumulostratus*: fair: *Stratus* at night. 16. Fine: *Cirrus* at evening. 17. A *Stratus* visible at four, a. m.: very fine day: luminous twilight, with the moon conspicuous: *Cirri* after sun-set. 19. Hot sun-shine: fair. 20. Lightning this evening. 21. *Stratus* at night. 22. Continued thunder in the SE, p. m. 23. Rather cloudy, a. m.: a fine breeze. 24. Morning cloudy, then fine: in the evening, heavy rain, with hail, thunder, and lightning: hydr. before the storm at 36°. 25. Cloudy morning. 26. Misty morning: drizzling rain: then fine. 27. A thunder-storm between six and seven in the evening: very heavy rain, with thunder and lightning. 28. Heavy showers, evening. 29, 30. Cloudy, with showers.

Seventh Month.—5. Thunder in a mass of clouds to the south and south-west: some rain with us.

RESULTS.

Winds variable.

Barometer: Greatest height	30·23 inches
Least	29·17
Mean of the period	29·751
Thermometer: Greatest height	86°
Least	34
Mean of the period	61·38
Mean of the hygrometer, 47·5°.	Rain, 2·81 in.

TOTTENHAM,
Seventh Month, 21, 1817.

L. HOWARD.

ANNALS

OF

PHILOSOPHY.

SEPTEMBER, 1817.

ARTICLE I.

Biographical Account of Dr. Ingenhousz.
By the late Maxwell Garthshore, M.D. F.R.S.

JOHN INGENHOUSZ was born of a mercantile family in Breda, in the year 1730. He was educated at schools there, and afterwards studied at more than one of the Dutch or German Universities. He took a degree in physic, and settled in his native town, where he practised with success for a few years: but of this practice he soon became tired; and, being naturally indifferent of money, though at the same time strictly economical, and having a moderate independence, he could no longer resist his ardent love of knowledge, and at once determined to sacrifice his hopes of gain at Breda; and, like Pythagoras, Plato, and others, to visit countries and people from whom more could be learned.

From the publications of the Royal Society, and the characters of our philosophers, he was induced to come to London in 1764, and was luckily introduced to Sir John Pringle, through whom he became acquainted with Dr. Franklin, Dr. Huxley, and all that circle of literary men that then attended his Sunday and Wednesday nights' meetings. The unassuming mildness and unaffected simplicity of our philosopher's manners, with his unremitting attention to scientific pursuits, soon gained him the favour of all; and his peculiar attention and accommodating respect to Sir John, who was always partial to foreigners, thinking they did more justice to his merit than his own countrymen, rendered Dr. Ingenhousz a particular favourite, and, by degrees, his constant visitor and attendant on all occasions.

Electricity being then a subject of much philosophic discussion, he employed himself assiduously in experiments on that subject, and contrived many ingenious methods of improving electrical machines, varying the methods of employing them. He at that time contrived a small machine, which he always carried in his pocket, and with which he used occasionally to amuse his friends. This naturally produced a degree of intimacy and favour with Dr. Franklin, then in high favour with this country as a philosopher; and with him and Sir John Pringle he made one summer a short trip to Paris; and afterwards, with Dr. Franklin alone, a tour through Scotland and Ireland. He continued to pursue his philosophical and medical studies and acquirements in London till the year 1767, when he was recommended by Sir John Pringle to the Imperial Ambassador, to go to Vienna, in compliance with the Empress Maria Theresa's desire, to inoculate her family, to whom the small-pox had been fatal. Though Dr. Ingenhousz had never before practised, or thought particularly of inoculation, yet such was Sir John's opinion of his sagacity, docility, and general knowledge of physic, and steadiness of character, that, after practising inoculation for some months with Baron Dimsdale, at Hertford, he made no scruple to send him out as fully qualified for that important office, which he successfully executed in the year 1768; and in the year 1769 he inoculated the Grand Duke of Tuscany's family, at Florence. He declined many solicitations to inoculate at the Court of Turin; and, returning straight to Vienna, he was appointed Body Physician and Counsellor of State to their Imperial Majesties, with a pension for life. He continued in Vienna for some time, pursuing his philosophical and medical studies. What practice he attended to, I believe, was gratuitous.

He applied himself much to ingenious inventions and experiments; with which he used to amuse the nobility, foreign ministers, and curious strangers, at Vienna, in so striking a way as to gain himself a very high reputation for his natural magic.

He some time after obtained leave to travel to France, to gratify his original turn of mind, by witnessing the various experiments and discoveries in pneumatic philosophy which then began to attract the attention of Europe. He was resident in Paris during the first commotions which took place on the revolution; and was so completely terrified by the outrages then committed, that he conceived the most indelible detestation of the principles and practice of the democrats, which he ever retained. While at Paris he lived much with Rochfoucault de Maret, and with those other philosophers who were most eminent for their attention to, and discoveries in, pneumatic philosophy.

After his success at Vienna, he came to England, in January, 1778, and employed himself chiefly in the pursuit of pneumatic philosophy; for which purpose he retired to the country, near London, for some months; and, after a long and laborious course of close investigation, he published at London, in 1779, his expo-

riments on vegetables, demonstrating their power of emitting vital air in sunshine, and azote in the night. These experiments he often repeated, improved, multiplied, and republished, on the continent, with various other philosophical essays, in French, German, and Latin editions. Of the *Experiences sur les Vegetaux*, he published at Paris, in 1787, the first volume, as a much augmented and corrected translation of the English publication of 1779; and, on his second journey to Paris, in 1789, a second volume of the same work, with much more extended views.

On his return to Vienna, he married a sister of Professor Jacquin, by whom he had no children, and with whom he did not live many years: his fondness for travelling, and his extreme attachment to England, engrossed the whole of his remaining life; and that will be best understood by attending to the chronology and analysis of his publications, which, being numerous, can be noticed in a life of this kind only in a summary way.

The order of his publications, separate from those already mentioned in our Transactions, are, first, his *Experiments on Vegetables*, published in London in 1779, before his first return to Vienna; a translation of which into Dutch was soon after published at the Hague, by Van Breda; and a German translation at Leipsic, by Molitor, in 1780; each of which was more enlarged than the original: and, what is remarkable, there were four different editions, published in four different languages, of this work, and all of them in the course of a few months. The first French translation being published soon after he passed through Paris to Vienna, in the year 1780, a second and much enlarged German edition of this work was published at Vienna, in three volumes, in 1786: and a second French edition of the first volume of the same work was published at Paris in 1787; and the second, with many additional improvements, in 1789.

His *Nouvelles Experiences sur divers Objets de Physique* was published in German by M. Molitor, Professor at Mayeince; and a second part of the same in 1782: and a second edition of this work was printed in 1784, containing a number of papers already published in our Transactions: and all this happened before the publication of the original French edition, which, although it had been finished and sent to Paris in 1781, was very unreasonably delayed by the French publisher till 1785. This volume begins with a very correct and precise account of the system of electricity by Dr. Franklin: and the second memoir is a very ingenious explanation of all the phenomena of the electrophorus invented by Volta on his theory of positive and negative electricity, the greatest part of which he had already published as a Bakerian Lecture in the *Philosophical Transactions* for the year 1778. In the third memoir he discusses at great length the much disputed question whether points or balls are the best contrivance to preserve buildings from the effects of lightning. He enters into an examination of Mr. Wilson's experiments performed at the Pantheon, and endeavours to establish the supe-

riority of pointed conductors in opposition to that gentleman, who asserted that they ought to terminate in balls; which last, he says, will rather attract a strong shock; whereas the other, by acting at a much greater distance, will silently and gradually attract and convey to the earth the electrical fire, and so prevent its ever occasioning a severe stroke.

The following memoirs are chiefly employed in experiments on inflammable and dephlogisticated air; in describing air pistols, and lamps; a method of procuring inflammable air from marshes, and in other ways; how to produce the most dazzling light; and how to light a candle at pleasure with an electrical spark; several of which are to be found in our Philosophical Transactions.

In the 13th memoir we have a long account of the nature and best means of obtaining dephlogisticated air from various substances, and especially from nitre. He next republished his paper upon the salubrity of common air at sea compared with the air of the sea coast and of inland countries, which we have in the Transactions for 1780. We next have a memoir on magnetism and artificial magnets: next a republication of his theory of gunpowder, and of pulvis fulminans. The 18th memoir is on the passage of heat through, and inflammability of, metals; with an attempt to determine the quantity of phlogiston which different metallic and other bodies contain.

Previous to his publication on vegetables, in 1779, he had in the year 1775 published in our Philosophical Transactions, vol. lxxv. his experiments on the torpedo, which at that time, from the previous experiments of Mr. Walsh, was exciting much attention; and that subject was further cultivated by experiments on the gymnotus, and by the very accurate anatomical observations of the late eminent Mr. John Hunter. In the year 1776 he published, in vol. lxxvi., an easy method of measuring the diminution of bulk taking place in the mixture of common and nitrous air, according to the discovery of Dr. Priestley; and he there describes an instrument he had contrived, whereby this nice experiment might be performed with much more facility and accuracy. In the same paper he published his experiments on platina, which, then a new metal, he had taken much pains to investigate and render fusible. He valued highly a set of buttons of this metal, with which he had a coat mounted. He found platina to be as completely, though not so strongly, magnetic as iron; and that this power was increased by fusion in electrical fire, which he first effected, whilst common fire was found to diminish it; and this magnetic virtue he constitutes as a specific property of platina, by which it may be always distinguished from gold, which cannot be rendered magnetic.

In the year 1778 we find a paper in the Phil. Trans. vol. lxxviii. describing a ready way to light a candle by a very moderate electrical spark excited positively by a piece of glass, and a match made of cotton powdered with resin. In the 48th paper of the same volume we find electrical experiments to explain how far the phe-

nomena of the electrophorus may be accounted for on Dr. Franklin's theory of positive and negative electricity, which he proves to agree perfectly with those exhibited by the late Mr. Canton with elder pith balls hanging by linen threads from a wooden box; which balls are excited either negatively or positively by a piece of excited glass.

In vol. lxi., for the year 1779, he gives an account of a new kind of inflammable air, or gas, which can be made in a moment without apparatus, and is as fit for explosion as other inflammable gases in use for that purpose; together with a new theory of gunpowder.

In October of the same year (1779) he published the first edition of *Experiments on Vegetables*, before mentioned. To this he prefixes a most grateful dedication to Sir John Pringle, explaining at length the whole series of obligations he was under to him for his early patronage on his first arrival in this country, and for his very extraordinary mark of confidence and respect in recommending him to the Imperial Family of Germany, leaving this as a public testimony of his gratitude, being then about to return to Vienna.

In the end of vol. lxi., for 1779, we find a memoir on improvements in electricity, delivered as a Bakerian lecture, which were performed by the use of flat glasses, instead of globes or cylinders, which it now appears he had made use of for 15 years. In vol. lxx. for the year 1780, we find a paper on the degree of salubrity of the common air at sea in the Channel compared with that on the shore, and in various parts of Holland. In a letter written from Paris in January, 1780, and in vol. lxxii., for the year 1782, we find some further considerations on the influence of the vegetable kingdom on the animal creation.

In the year 1784 there were two volumes, in octavo, of his various philosophical papers published in German at Vienna. In 1785 we find *Nouvelles Experiences et Observations sur divers Objets de Physique*, which wholly consist of subjects of electricity, and the different kinds of air, being chiefly what had been before published in our Transactions. This he dedicates to Dr. Franklin, then residing at Paris, as Minister Plenipotentiary from the United States of America. In the year 1789 he published a second volume with the same title, dedicated to Baron Dimsdale, and printed under his own eye at Paris. The second volume contains chiefly experiments and observations relating to vegetables, and especially to that green matter produced in water, on which so much had been said by Dr. Priestley. These two volumes are pretty much the same with those that have been published in German, in which there were also some medical as well as physical papers, which, by a mistake of the editors, were omitted in the French edition.

His last publication, in the year 1798, preceding his death, is an essay on the food of plants and the renovation of soils, written at the desire of Sir John Sinclair, and published by the Board of Agriculture, of which he was President, and of which our philoso-

pher had been made a Foreign Honorary Member. In this paper we have an abridged recapitulation and very ingenious application of his experiments and opinions, so fully illustrated in his *Experiences sur les Vegetaux*, published at Paris in two volumes, 8vo. in the year 1787 and 1789, to which he continually refers. He surely was the first who demonstrated clearly the singular facts of pure oxygen being continually emitted by vegetables when under the influence of light, by which the air was continually ameliorated, and that of their constantly emitting azote in the dark, by which it is corrupted. It is very true that Dr. Priestley had before him discovered that living plants always ameliorated the atmospheric air, by absorbing phlogiston, a theory in direct opposition to that of our philosopher, who thought this purification was occasioned by their perspiration instead of absorption, which continual absorption of atmospheric air he also allows; and proves, by some most ingenious experiments, that plants derive great part of their nourishment by their leaves; and that respirable air and heat are absolutely necessary to vegetation, though light is not, as they can grow very luxuriantly in the dark, but will emit no oxygen, acquire no green colour, and rather taint than ameliorate the air. As far as concerns the economy of vegetables, he certainly has thrown more light than any other philosopher since the time of Hales, whose ingenuity and success must render him immortal. Though it require too much of the reader's time to enumerate the variety of ingenious inventions and discoveries which he has published, yet I cannot omit making mention of that very brilliant experiment—the deflagration of solid iron in vital air; of which he was so very fond that he always carried a phial of it in his pocket, in which he used frequently to burn a piece of iron wire, to the great entertainment of his female friends.

ARTICLE II.

Chemical Analysis of Tin from the different Smelting Houses in Cornwall. By Thomas Thomson, M.D. F.R.S.

It would appear that there exists on the Continent a prejudice against Cornish tin, or an opinion that it is not pure, but artificially alloyed with some other metal. Some of the gentlemen connected with the tin trade in Cornwall conceived it possible that there might be some particular smelting-house which sent impure tin into the world, adulterating it artificially, for the sake of profit. To verify this suspicion, specimens of tin from every smelting-house in Cornwall were put into my hands, for the purpose of determining, by a careful analysis, the foreign metals with which they might be contaminated. I shall state in this paper the results which I obtained.

The specimens subjected to experiment were 14 in number, collected from as many different smelting-houses, without the smelters being aware beforehand of the object in view when the specimens were collected.

The following table exhibits the specific gravity of these specimens, numbered as they were when I received them:—

No. 1	Specific gravity	7·2960 at 60°
2	7·2930
4	7·2943
6	7·2890
7	7·2933
8	7·2881
9	7·3209
10	7·3046
11	7·2853
12	
13	7·2974
14	7·2934
15	7·2975
16	7·3082

My mode of analysing these specimens was the following:— I poured nitric acid diluted with twice its weight of water upon a determinate quantity of each specimen, and continued the digestion till the whole of the tin was converted into a white powder, adding fresh acid when it became necessary. It was then exposed to heat, in order that all the tin might be peroxidated, and that none of it might remain in solution in the acid. The whole was now thrown upon a filter; and the white hydrate of tin which remained wasedulcorated with water till that liquid came off tasteless. The hydrate of tin was then dried upon the filter, exposed to a red heat, and weighed. The peroxide of tin thus obtained was a yellow powder, which was considered as a compound of 7·375 tin and 2 oxygen. Knowing the weight of this peroxide, it was easy to determine the proportion of pure tin contained in the specimen under examination.

The liquor which had passed through the filter was concentrated by evaporation. A drop of it was let fall into a solution of sulphate of soda, but no cloudiness whatever could be perceived. Hence I concluded that none of the tins contained lead.

When a drop from each of them was let fall into a solution of nitrate of lead, no cloudiness whatever appeared. Hence I concluded that no arsenic acid was present in the solution, and that therefore none of the tins had contained arsenic as an ingredient.

All of the specimens, except the solution from No. 9, became slightly blue when treated with prussiate of potash. They therefore contained iron. By comparative experiments with liquids containing known weights of iron in solution, I endeavoured to ascertain the quantity of iron which had been dissolved from each specimen

of tin. The quantity varied from $\frac{1}{10000}$ th of the weight of the tin, which was the greatest portion, to $\frac{1}{100000}$ th, which was the smallest that I could pretend to determine. Nos. 4, 7, 8, and 14, contained about $\frac{1}{1000}$ of their weight of iron. No. 9 contained no sensible portion. In none of the others could the proportion of iron exceed $\frac{1}{10000}$ th of the weight of the tin.

Ammonia, being poured into the solution, detected copper in all the solutions, except that from No. 1; or at least the quantity in No. 1 was so small, that it was obviously impossible to separate it and weigh it. From all the other solutions I threw down the copper by immersing a plate of zinc into the liquid.

The following table exhibits the weight of copper which I separated from 1000 grains of each of the tins examined;—

No. 1	yielded only a trace of copper
2 1·0 grain
4 1·0
6 0·4
7 1·5
8 1·0
9 2·0
10 0·5
11 0·1
12 0·2
13 1·0
14 1·0
15 1·5
16 2·0

Thus we see that Nos. 9 and 16 were the most impure, each of them containing $\frac{1}{500}$ th of its weight of copper. Nos. 1, 11, and 12, were the purest. No. 11 contains $\frac{1}{100000}$, No. 12 $\frac{1}{30000}$, of its weight of copper; and No. 1, a quantity of copper which probably did not exceed $\frac{1}{1000000}$ th of its weight. The average quantity of copper contained in Cornish tin, provided these specimens constitute a fair criterion, as it is probable they do, is about $\frac{1}{1000}$ th part of the weight of the tin. When the tin is dissolved in muriatic acid, as it is for the purposes of the dyer, this copper remains undissolved, and constitutes the well-known black powder which is obtained when tin is dissolved in that acid. The cupreous portion, therefore, cannot be in the least injurious to the tin when it is to be employed as a mordant. It is evident that this small portion of copper is derived from the copper ore which still remains mixed with the tin ore after it is dressed, and made as free from impurities as possible for the use of the smelters. The copper ore in Cornwall is chiefly copper pyrites, and it is separated from the tin ore by washing; for the difference between the specific gravity of tin ore and copper pyrites is so great, that they may be separated from each other by means of exposure to a current of water. It would be curious to know whether the tins of Nos. 9 and 16, which contain

the most copper, may not be obtained by smelting tin ore which is mixed in the mine with some copper ore of a greater specific gravity than copper pyrites.

The small quantity of iron contained in these tins may possibly be derived from the tin-stone itself, which probably always contains a small portion of iron. If this be the origin, it would be hopeless to look for tin totally free from iron. The presence of iron in tin was rather unexpected by me, as the affinity between iron and tin is so feeble that it was supposed, till Bergman demonstrated the contrary, that the two metals could not be united. I reduced the specimens of tin, which I analyzed, by fixing each into a vice, and pulling off the requisite pieces by means of a pair of pliers. It occurred to me as possible that the small traces of iron which I discovered in each solution might have been abraded from the vice or the pliers; but, on dissolving a portion of tin not thus treated, the iron was still perceptible in the solution. I think myself warranted, therefore, in concluding that the iron existed in the specimens.

I tried various other modes of analysis besides the foregoing; for example, I endeavoured to separate the copper from the iron by a current of sulphureted hydrogen gas. I tried likewise to throw down the iron by means of caustic ammonia, which retained the copper in solution; but in the 100 grains of each specimen which I subjected to analysis, the quantity of iron was so exceedingly small that, when I attempted to collect and weigh it, my results were much more inaccurate than those deduced by estimation from the intensity of the colour produced by prussiate of potash.

I think the preceding analysis does great credit to the Cornish tin smelters. It shows that there is no foundation for the opinion that any of them adulterate their tin by the addition of any foreign metal. The presence of $\frac{1}{500}$ th of alloy, which characterizes Nos. 9 and 16, the most impure specimens, I consider as a very small quantity; nor is it likely that it can be injurious to the metal for any of the purposes to which it is usually applied. The opinion entertained on the continent of the impurity of Cornish tin is owing probably to pewter having been frequently mistaken for that metal. The same French word, *etain*, signifies both *tin* and *pewter*. Pewter, as is well known in this country, is tin alloyed with another metal, usually *antimony* or *lead*.

ARTICLE III.

A General Formula for the Analysis of Mineral Waters.

By John Murray, M.D. F.R.S.E.

(Continued from p. 98.)

THE method proposed by Dr. Wollaston, of precipitating magnesia from its solution, by first adding carbonate of ammonia, and

then phosphate of soda, so as to form the insoluble phosphate of ammonia and magnesia, is one much more perfect; the whole of the magnesia appears to be precipitated; and as a method, therefore, of determining the quantity of this base, it is probably unexceptionable. It does not, however, altogether accord with the object of the present formula. The soda of the phosphate of soda serves to neutralize the muriatic acid of the muriate of magnesia; a quantity of muriate of soda is of course formed, which remains with the muriate of soda of the water, and the amount of which, therefore, it is necessary to determine with accuracy. This may be done from the quantity of phosphate of magnesia obtained giving the equivalent portion of muriate of soda, either by means of the equivalents of the acids, or of the bases. But still this renders the method somewhat complicated; and it may be liable to some error, if any excess of phosphate of soda be added, which, in order to precipitate the magnesia entirely, it may be difficult to avoid; this excess remaining with the muriate of soda, and rendering the estimate of it incorrect. And independent of these circumstances, it would be preferable to give uniformity to the operation, by employing some method by which the product in this, as well as in the previous steps, is removed, at the end of the analysis, leaving only the muriate of soda.

It seemed probable that this might be attained by employing phosphoric acid with the carbonate of ammonia to form the triple phosphate of ammonia and magnesia, such an excess of ammonia being used as should both be sufficient for the constitution of this compound, and for the neutralization of the muriatic acid of the muriate of magnesia; muriate of ammonia would thus be substituted, the same as in the preceding step of precipitating the lime, which at the end would be expelled by heat, leaving muriate of soda alone. I accordingly found that when this variation of the process was employed, the clear liquor, after the precipitation, was not affected by the addition either of phosphate of soda with ammonia, or of subcarbonate of soda,—a proof that the separation of the magnesia had been complete. To establish its accuracy with more certainty, the following experiments were also made.

Twenty grains of muriate of soda (pure rock salt), which had been exposed to a red heat, and 10 grains of crystallized muriate of magnesia, were dissolved in an ounce of water, at the temperature of 100° . The phosphate of soda and carbonate of ammonia were then employed to precipitate the magnesia in the mode proposed by Dr. Wollaston; that is, a solution of the ammoniacal carbonate was first added, and afterwards a solution of phosphate of soda, as long as any precipitation was produced, taking care to preserve in the liquor a slight excess of the ammonia. The precipitate, being washed and dried, afforded, after exposure to a red heat for an hour, 5.4 grains of phosphate of magnesia, equivalent to 2.15 of magnesia. The clear liquor being evaporated, muriate of soda was obtained, which, after exposure to a red heat, weighed 25.7

grains. Phosphate of magnesia being composed of 39·7 of magnesia, with 60·3 of phosphoric acid, 5·4 grains of it are equivalent to 6·4 grains of muriate of soda, and this deducted from the quantity obtained 25·7, leaves 19·3 as the quantity originally dissolved.

A solution perfectly the same was prepared, and a solution of carbonate of ammonia was added to it as before. A strong solution of phosphoric acid was then dropped in, as long as any precipitation was produced, observing the precaution of having always an excess of ammoniacal carbonate in the liquor. The precipitate, being washed and dried, afforded, after exposure to a red heat, 5·5 grains of phosphate of magnesia, equivalent to 2·19 of magnesia. The clear liquor being evaporated, and the dry matter being exposed to a heat gradually raised to redness, weighed, when cold, exactly 20 grains.

In both experiments the quantity of muriate of soda is accurately obtained, or as nearly so as can be expected. They correspond, too, as nearly as can be looked for, even in a repetition of the same experiment, in the quantity of magnesia which they indicate. To ascertain how far this corresponded with the real quantity, I converted 10 grains of the crystallized muriate of magnesia into sulphate by the addition of sulphuric acid, and exposed it to a low red heat; the product weighed 6·4 grains, equivalent to 2·13 of magnesia. This may be regarded as a perfect coincidence, and as establishing the accuracy of the other results.*

It thus appears that phosphoric acid with an excess of ammonia may be employed to precipitate magnesia from its saline combinations; and in a process such as the present, it has the advantage that the muriate of ammonia formed can be afterwards volatilized by heat, and the quantity of any residual ingredient can of course be easily ascertained. Neutral phosphate of ammonia would also have this advantage; but it does not succeed, phosphate of magnesia not being sufficiently insoluble. On adding a solution of phosphate of ammonia to a solution of sulphate of magnesia, the mixture became turbid in a minute or two, and in a short time a precipitate in crystalline grains formed at the bottom and sides; but it was not considerable, and did not increase. Phosphate of ammonia, however, with an excess of ammonia, or with the previous addition of carbonate of ammonia, may be employed with the same effect as phosphoric acid. In applying the phosphoric acid to this purpose under any of these forms, it is necessary to be careful that it be entirely free from any impregnation of lime.

There is one other advantage which this method has, that if even a slight excess of phosphoric acid be added, the error it can intro-

* According to the result of this last experiment, 100 grains of crystallized muriate of magnesia would give 64 of real sulphate of magnesia, composed of 21·3 of magnesia, and 42·7 of sulphuric acid. This quantity of sulphuric acid is equivalent to 29·4 of muriatic acid. Hence 100 grains of this salt crystallized (in which state its composition, I believe, has not been determined) consist of 21·3 magnesia, 29·4 muriatic acid, and 49·3 of water.

duce must be extremely trivial; for the effect of it will be only to decompose a small portion of the original muriate of soda; and the difference is very inconsiderable in the proportion in which phosphoric and muriatic acids combine with soda, any difference of weight which may arise from this substitution, to any extent to which it can be supposed to happen, may be neglected as of no importance.*

To apply this method, then, to the present formula: add to the clear liquor poured off after the precipitation of the oxalate of lime, heated to 100°, and, if necessary, reduced by evaporation, a solution of carbonate of ammonia; and immediately drop in a strong solution of phosphoric acid, or phosphate of ammonia, continuing this addition with fresh portions, if necessary, of carbonate of ammonia, so as to preserve an excess of ammonia in the liquor as long as any precipitation is produced. Let the precipitate be washed; when dried by a heat not exceeding 100°, it is the phosphate of ammonia and magnesia containing .019 of this earth; but it is better, for the sake of accuracy, to convert it into phosphate of magnesia by calcination for an hour at a red heat: 100 grains, then, contain 40 of magnesia.

Evaporate the liquor remaining after the preceding operations to dryness, and expose the dry mass to heat as long as any vapour exhale, raising it towards the end to redness. The residual matter is muriate of soda, 100 grains of which are equivalent to 53.3 of soda and 46.7 of muriatic acid. It is not, however, to be considered necessarily as the quantity of muriate of soda contained in the water: for a portion of soda may have been present above that combined with muriatic acid, united, for example, with portions of sulphuric or carbonic acid; and from the nature of the analysis, this, in the progress of it, or rather in the first step, that of the removal of these acids by the muriate of barytes, would be com-

* For the sake of comparison, and to ascertain the accuracy of different methods, I submitted a similar solution of muriate of magnesia and muriate of soda to analysis by subcarbonate of ammonia. To the saline liquor, heated to 100°, a solution prepared by dissolving carbonate of ammonia in water of pure ammonia was added until it was in excess. A precipitation rather copious took place; the precipitate being collected on a filter, the clear liquor was evaporated to dryness, and the saline matter was exposed to heat, while any vapours exhaled. Being re-dissolved, a small portion remained undissolved; and on again adding subcarbonate of ammonia to the clear liquor, precipitation took place, rather less abundant than at first. This was repeated for a third, and even for a fourth time, after which the liquor was not rendered turbid. Being evaporated, the muriate of soda obtained, after exposure to a red heat, weighed 20.5 grains. The whole precipitate washed, being heated with sulphuric acid, afforded of dry sulphate of magnesia 4.8 grains, a quantity inferior to that obtained by the other methods, evidently owing to the less perfect action of the ammoniacal carbonate as a precipitant. A similar deficiency in the proportion of magnesia was found in the analysis of sea water by subcarbonate of ammonia, as has been already stated: while, on the other hand, in its analysis by phosphate of soda and carbonate of ammonia, a larger quantity of muriate of soda was obtained than by the other methods, probably from the difficulty of avoiding an excess of phosphate of soda in precipitating the magnesia.

mixed with muriatic acid. It does not, therefore, give the original quantity of that acid; but it gives the quantity of soda, since no portion of this base has been abstracted, and none introduced.

The quantity of muriatic acid may have been either greater or less than that in the muriate of soda obtained. If the quantity of soda existing in the water exceeded what the proportion of muriatic acid could neutralize, this excess of soda being combined with sulphuric or carbonic acid, then, in the removal of these acids by muriate of barytes, muriatic acid would be substituted, which would remain in the state of muriate of soda; and if the quantity considered as an original ingredient were estimated from the quantity of this salt obtained, it would be stated too high. Or if, on the other hand, more muriatic acid existed in the water than what the soda present could neutralize, the excess being combined with the other bases, lime or magnesia, then, as in the process by which these earths are precipitated, this portion of the acid would be combined with ammonia, and afterwards dissipated in the state of muriate of ammonia, if the original quantity were inferred from the weight of the muriate of soda obtained, it would be stated too low.

To find the real quantity, therefore, another step is necessary. The quantities of bases and of acids procured (taking the quantity of muriatic acid existing in the muriate of soda obtained) being combined according to the known proportions of their binary combinations, if any portion of muriatic acid has been abstracted, the bases will be in excess, and the quantity of this acid necessary to produce neutralization will be the quantity lost; or, on the other hand, if any portion of muriatic acid has been introduced, and remains beyond that originally contained in the water, this quantity will be in excess above what is necessary to produce neutralization. The simple rule, therefore, is to combine the elements obtained by the analysis, in binary combinations, according to the known proportions in which they unite; the excess or deficiency of muriatic acid will then appear; and the amount of the excess being subtracted from the quantity of muriatic acid contained in the muriate of soda obtained, or the amount of the deficit being added to that quantity, the real quantity of muriatic acid will be obtained.*

There is one deficiency, however, in this method. If any error has been introduced in any previous step of the analysis, either in the estimation of the bases or of the acids, this error will be concealed by the kind of compensation that is made for it, by thus adapting the proportion of muriatic acid to the results such as they are obtained; and at the same time an incorrect estimate will be made of the quantity of muriatic acid itself. When any error, therefore, can be supposed to exist, or, independent of this, to ensure perfect accuracy, it may be proper to estimate directly the

* See the notice of an analysis of sea water in illustration of this. (*Annals of Philosophy*, vol. ix. p. 50.)

quantity of muriatic acid in a given portion of the water, by abstracting any sulphuric or carbonic acid by nitrate of barytes, and then precipitating the muriatic acid by nitrate of silver or nitrate of lead. The real quantity will thus be determined with perfect precision, and the result will form a check on the other steps of the analysis, as it will lead to the detection of any error in the estimate of the other ingredients; for when the quantity is thus found, the quantities of these must bear that proportion to it which will correspond with the state of neutralization.

Thus by these methods the different acids and the different bases are discovered, and their quantities determined. To complete the analysis, it remains to infer the state of combination in which they exist. It will probably be admitted that this must be done on a different principle from that on which the composition of mineral waters has hitherto been inferred. The compounds which may be obtained by direct analysis cannot be considered as being necessarily the real ingredients, and to state them as such would often convey a wrong idea of the real composition. There are two views according to which the state of combination in a saline solution may be inferred, and in conformity to which, therefore, the composition of a mineral water may be assigned. It may be supposed that the acids and bases are in simultaneous combinations. Or if they be in binary combinations, the most probable conclusion with regard to this, as I have already endeavoured to show,* is, that the combinations are those which form the most soluble compounds, their separation in less soluble compounds, on evaporation, arising from the influence of the force of cohesion. In either of these cases the propriety of first stating as the results of analysis the quantities of acids and bases obtained is obvious. On the one supposition, that of their existing in simultaneous combination, it is all that is to be done. On the other supposition, the statement affords the grounds on which the proportions of the binary compounds are inferred: and there can be no impropriety in adding the composition conformable to the products of evaporation. The results of the analysis of a mineral water may always be stated, then, in these three modes: 1. The quantities of the acids and bases. 2. The quantities of the binary compounds, as inferred from the principle that the most soluble compounds are the ingredients; which will have at the same time the advantage of exhibiting the most active composition which can be assigned, and hence of best accounting for any medicinal powers the water may possess. 3. The quantities of the binary compounds, such as they are obtained by evaporation, or any other direct analytic operation. The results will thus be presented under every point of view.

It is obvious that the process I have described, adapted to the most complicated composition which usually occurs, is to be modified according to the ingredients. If no lime, for example, is

* Analysis of the Mineral Waters of Dunblane and Pitcaithly, &c. *Annals of Philosophy*, vol. vi. p. 256.

present, then the oxalate of ammonia is not employed; and in like manner with regard to the others. I have also supposed the usual and obvious precautions to be observed, such as not adding an excess of any of the precipitants, bringing the products to a uniform state of dryness, &c. having mentioned only any source of error less obvious, or peculiar to the process itself.

With regard to other ingredients, either not saline, or more rarely present, it will in general be preferable, when their presence has been indicated by the employment of tests, or by results occurring in the analysis itself, not to combine the investigation to discover them with the general process above described, but to operate on separate portions of the water, and to make the necessary allowance for their quantities in estimating the other ingredients. The quantity of iron, for example, in a given portion of the water, may be found by the most appropriate method. Silica will be discovered by the gelatinous consistence it gives on evaporation, and forming a residue insoluble in acids, but dissolved by a solution of potash. Alumina may be discovered in the preliminary application of tests, by the water giving a precipitate with carbonate of ammonia, which is not soluble, or is only partially soluble in weak distilled vinegar, but is dissolved by boiling in a solution of potash, or by its precipitation from the water sufficiently evaporated by succinate of soda; or in conducting the process itself, it will remain in solution after the precipitation of the lime by the oxalic acid, and be detected by the turbid appearance produced on the addition of the carbonate of ammonia previous to the addition of the phosphoric acid to discover the magnesia. Its quantity may then be estimated from its precipitation by carbonate of ammonia, or by other methods usually employed. Silica will also be precipitated in the same stage of the process; its separation from the alumina may be effected by submitting the precipitates, thoroughly dried, to the action of diluted sulphuric acid. Potash, when present, which is very seldom to be looked for, will remain at the end, in the state of muriate of potash. Muriate of platina will detect its presence, and the muriate of potash may be separated by crystallization from the muriate of soda.

There is another mode in which part of the analysis may be conducted, which, although perhaps a little less accurate than that which forms the preceding formula, is simple and easy of execution, and which may hence occasionally be admitted as a variation of the process; the outline of which, therefore, I may briefly state.

The water being partially evaporated, and the sulphuric and carbonic acids, if they are present, being removed by the addition of muriate of barytes, and the conversion of the whole salts into muriates effected in the manner already described; the liquor may be evaporated to dryness, avoiding an excess of heat, by which the muriate of magnesia, if present, might be decomposed; then add to the dry mass six times its weight of rectified alcohol (of the spe-

cific gravity at least of $\cdot 835$), and agitate them occasionally during 24 hours, without applying heat. The muriates of lime and magnesia will thus be dissolved, while any muriate of soda will remain undissolved. To remove the former more completely, when the solution is poured off, add to the residue about twice its weight of the same alcohol, and allow them to stand for some hours, agitating frequently. And when this liquor is poured off, wash the undissolved matter with a small portion of alcohol, which add to the former liquors.

Although muriate of soda by itself is insoluble, or nearly so, in alcohol of this strength, yet when submitted to its action along with muriate of lime or of magnesia, a little of it is dissolved. To guard against error from this, therefore, evaporate or distil the alcoholic solution to dryness, and submit the dry mass again to the action of alcohol in smaller quantity than before; any muriate of soda which had been dissolved will now remain undissolved, and may be added to the other portion; or at least any quantity of it dissolved must be extremely minute. A slight trace of muriate of lime or of magnesia may adhere to the muriate of soda; but when a sufficient quantity of alcohol has been employed, the quantity is scarcely appreciable; and the trivial errors from these two circumstances counteract each other, and so far serve to give the result more nearly accurate.

Evaporate the alcohol of the solution, or draw it off by distillation. To the solid matter add sulphuric acid, so as to expel the whole muriatic acid; and expose the residue to a heat approaching to redness, to remove any excess of sulphuric acid. By lixiviation with a small portion of water, the sulphate of magnesia will be dissolved, the sulphate of lime remaining undissolved, and the quantities of each, after exposure to a low red heat, will give the proportions of lime and magnesia. The quantity of soda will be found from the weight of the muriate of soda heated to redness; and the quantities of the acids will be determined in the same manner as in the general formula.

This method is equally proper to discover other ingredients which are more rarely present in mineral waters. Thus alumina will remain in the state of sulphate of alumina along with the sulphate of magnesia, and may be detected by precipitation by bicarbonate of ammonia. Silica will remain with the muriate of soda after the action of the alcohol, and will be obtained on dissolving that salt in water: and iron will be discovered by the colour it will give to the concentrated liquors, or the dry residues, in one or other of the steps of the operation.

The general process I have described may be applied to the analysis of earthy minerals. When they are of such a composition as to be dissolved entirely, or nearly so, by an acid, that is, where they consist chiefly of lime, magnesia, and alumina, its direct ap-

plication is sufficiently obvious; where they require the previous action of an alkali from the predominance of siliceous earth, on this being separated, the excess of alkali may be neutralized by muriatic acid; and the remaining steps of the analysis may be prosecuted, with any modification which the peculiar composition will require. As the quantities of the ingredients are capable of being estimated with so much precision, it may be employed with more peculiar advantage where a small quantity only of the mineral can be submitted to analysis; and when it is employed, such a quantity only, 10 grains, for example, ought to be made the subject of experiment.

ARTICLE IV.

On the Vessels of Plants. By G. Wahlenberg, M.D. of Upsala, Member of the Royal Academy of Sciences of Stockholm.*

A DIFFERENT view of the same observations often leads to a very different result, although no mistake exists in the observations themselves. It is difficult to get out of the trammels of former opinions and conclusions; and nowhere more so than in the anatomy and physiology of plants. If we depend upon pure anatomical observations, our conclusions will be very different from what they will be if we call in the aid of physiology.

Even the name *organs of plants* throws us into some difficulty, as they possess little of that constancy which is universally expected in *organs*, and even considered as belonging to them by the long use of the phrase. The organs of animals and their functions are universally known; and it would be impossible to alter their names, on account of any different view respecting their uses. Were the same thing the case in the anatomy of plants, and could the same confidence be put in the generally received opinions, as may be in the anatomy of animals, the progress of the science would not be so vacillating. In my treatise on the Situation of the immediate Products of Plants,† it was my object to steer as clear as possible of the vulgar opinions and notions relative to this intricate subject, in which respect I have deviated very much from the conduct of late writers. I cannot desist from speaking of *vessels*, because I found *vessels* through which the sap flowed with velocity. It appears to me more correct to say that the sap flows in the wood of the oak, through *wooden vessels* (*vasa lignea*), than that it flows through the cellular texture of the wood: and I cannot avoid believing that the

* Translated from Gilbert's *Annalen der Physik*, xlv. 42, Sept. 1813. The present paper is drawn up by Gilbert from one published by Wahlenberg in 1812.

† De sedibus Materialium immediatarum in Plantis Tractatio. Upsala, 1806 and 1807. A German translation of it is in *Gehlen's Journal f. Chemie, Phys. und Miner.* viii. 98.

fibres of the bark of the lime-tree are of a different kind from the fibres of the wood of the same tree, and the spongy cellular fabric of cork. All that by the late vegetable-anatomists is called *cellular substance* (*tela cellulosa*) is by the chemists called *wood* (*lignum*). In consequence of this mode of speaking, we have a *fibrous cellular substance* (a mode of speaking which, though common, seems hardly admissible), which is obviously nothing else than the *vascular cellular substance* (*vascularis cellulosa*).

It is not improbable that I have formed opinions different from those of others, in consequence of having examined a greater variety of trees and shrubs than other vegetable-anatomists. My object was to find in the old portions of them the *immediate products* deposited, which can scarcely be found in a substantial form in the tender parts of herbs. For several successive summers I traversed the woods of Wermeland, with a hatchet in my hand, and cut down a great number of trees, in order to examine the wood. I have examined likewise whole chests full of different species of trees which Afzelius brought from the part of Africa that lies between the tropics. I have likewise examined the different officinal woods, and the various species collected by Swartz in the West Indies. By Messrs. Rudolphi and Link, on the other hand, the different species of wood were considered as of little importance. Neither of them, for example, examined the wood of the Guaiacum; and the first of them has overlooked most of the Swedish woods, which are domesticated in Germany, as the *rhamnus fragula* and *catharticus*, in which the existence of cortical vessels is extremely doubtful, the *Sorbus aucuparia*, *Betula alba*, *Populus*, *Ulmus*, &c. It is not surprising, therefore, that I have come to results different from theirs; nor can these differences on my part be ascribed to any want of observations.

In order to separate the more solid parts of old wood from the wood itself, I have been accustomed to macerate slips of the wood in different solutions, and to treat them with re-agents. By this method I have ascertained several facts which are very strongly in favour of the existence of wooden vessels (*vasa lignea*) and cortical vessels (*vasa corticalia*). When a cross slip of a hard wood, *quercus robur*, for example, is macerated alternately in potash ley and nitric acid, we perceive in every canal of the tubular contexture (*contextus tubulosi*) a transparent, complete and round tube, which has a peculiar wall not communicating with the walls of the other tubes. These have every appearance of true tubes extending a great way in length, and I cannot give them any other name than that of wooden vessels (*vasa lignea*). In the elm are found harder rings, which contain peculiar wooden vessels in their tubular contexture, and at the same time extend further than the peculiar rings, in which no such vessels can be observed. I have particularly stated all this in the second and third sections of my dissertation; and I think it will be allowed me that no stronger anatomical proofs of the *existence of wooden vessels* can well be brought; but when I speak

of the woody vessels of the softer kinds of plants, as the *dirca palustris*, where the contexture is entirely cellular, I admit that it is not always possible to distinguish the harder wall from the softer tubular contexture. Hence, whenever the matter is doubtful, I have always referred the *contextus tubulosus* or *vascularis* to the vessels.

The term *vasa radiantia* is not perhaps so easily defended; yet I conceive that the retaining of this old name is excusable, and very convenient. These vessels act a very great part in all woods. As soon as towards harvest the leaves cease to grow, they draw the whole sap from without, over the whole wood, cambium, and the space between the wood and bark, into the bark itself. Through their activity, the bark is more firmly united to the wood, and filled with coloured sap, or at least sap which becomes coloured on exposure to the air. It appears as if the *liber* were at that time changed into wood; but this is not in reality the case; only at that season of the year the new bark assumes very distinctly the appearance of bark.

With what energy the sap can make its way through these *vasa radiantia*, I have observed with astonishment, when plants from warmer climates freeze with us in harvest. (See my treatise, p. 17). Suppose, for example, the upper part of the stem of the *bupleurum rotundifolium* to be frozen, and the roots still to retain their full activity, in that case the sap makes its way every night through the *vasa radiantia*, and freezes in handsome icicles, flowing directly out of the wood, and having the size and shape of these vessels. I removed these icicles every morning, and found them renewed every night in the same plant.

The *vasa radiantia* have likewise a very peculiar appearance. They run isolated and distinct from the inner part of the wood to the bark, often for a whole foot, without mixing with the woody vessels; and are so conspicuous, that, when we cleave beech wood, they display a splendid lustre, which the workmen have distinguished by the name of *silver grain* (*spiegelfasern*). They have strongly the appearance of bundles of vessels. In a foreign wood I can perceive circular holes lying near each other without the least trace of a true cellular texture. If we consider this appearance without any regard to other plants, it is anatomically proper to call these holes *vessels*: at least they give me no idea whatever of a stretched cell; and I consider the expression *stretched cellular texture which runs upwards*, as well as *stretched cellular texture which runs horizontally*, as inconvenient and inaccurate. How do we know that these canals are composed of stretched cells? When, on splitting a wood, we perceive how regularly the woody tubes run, and how they cross the *vasa radiantia*, how small is the resemblance which they present to a cellular texture!

When I call the *vasa radiantia* a peculiar set of vessels, I may be wrong. In fact, I would prefer calling them *vasa lignea radiantia*; but I consider it as inconvenient to employ three words

for a name. Besides, their peculiarity is sufficiently well marked to bear some ambiguity in their name; and I do not see why we should be so frugal of names in the anatomy of plants, when such freedom is made with them in botany, that even the most insignificant varieties are often dignified with names: and have not the different varieties of vessels as good a right to be distinguished by peculiar names as the different varieties of plants? Even supposing the *vasa radiantia* in vegetables to pass into a cellular texture, can any one be of opinion that in trees, where they are of a very different nature, they ought not to have a peculiar name?

Nearly the same considerations have induced me to give the name of *cortical vessels* (*vasa corticalia*) to some peculiar ones. They make their appearance in the bark of trees as tubes, or at least as a *tubular contexture* (*contextus tubulosus*). In their physical properties they are very different from the woody vessels. How flexible and tough are they not in the bark of the linden, the juniper, and the daphne mezereum, compared with the stiff and rough wooden vessels of the same plants? They are often still better distinguished from the *tela cellulosa* than from the woody vessels. For example, in the bark of the lime-tree they form very distinct pillars, the cross fracture of which appears wedge-shaped, with its basis turned towards the wood. By maceration in caustic potash, these tubes assume a yellow colour, become thicker, and may be very readily distinguished from the *tela cellulosa* and the woody vessels. They then form frequently distinct canals, whose round openings without any angles are very distinct, and may with strict anatomical propriety be considered as tubes. The cortical vessels are very distinct in the *rhamnus catharticus*, in the bark of which, by pulling it separate, we perceive long stiff hairs, consisting entirely of cortical vessels, with some separate cells.

The peculiar disposition of these tubes shows how much the wood differs from the bark, and that no layer of *liber* is capable of forming the new wood. According to my observations, the wood is not formed from the cortical layers. Indeed, in all bicotyledonous trees the wood and bark form two distinct circulations, which merely communicate to a certain extent in harvest. In spring, when the leaves have acquired a certain size, it appears very clearly that the new layer of wood is already formed. It is still very thin; but by degrees increases in thickness, through new vessels or tubes extending themselves outwards: and, towards harvest, before the bark becomes fastened to the wood, we find in young twigs the new wood often thicker than the whole bark. How then is it possible that it should have been formed from the bark, as is commonly believed? Either the cortical layers must the whole summer long be perpetually passing into wood, or the formation of the wood from these layers is quite impossible. According to my observations, the cortical vessels are formed quite in the same way as the woody vessels; they every now and then deposit new lamellæ on the inner side of the bark. Hence the interval between the bark and wood

is by no means the principal place where the sap flows. In the beginning of spring, when the sap flows with force in trees, the bark still adheres to the wood. The separation takes place when the new wood is deposited; and when the bark allows itself to be peeled off, the epidermis (as, for example, of the birch,) is not loose; it becomes so at a later period.

These circumstances point very different periods in the vegetation of trees. The sap in the first place flows into the wood through the woody vessels; then the new layer of wood is deposited; and, lastly, towards harvest, the bark swells considerably. During the growth of the wood, the union between the bark and the interior part of the tree is quite interrupted, so that only traces of the *vasa radiantia* can be perceived. But when in harvest the growth of the leaves and young twigs ceases, the ascending sap proceeds outwards, and fills the *vasa radiantia*, which then pass into the bark very distinctly.* By this means the bark is anew fixed to the wood: not in consequence of a gummy liquid, but from the formation of the *vasa radiantia*. The sap, which then first passes through them to the bark, fills the *tela cellulosa*; new cells are formed between the cortical vessels, so that the bark increases in extent in the same proportion as the wood increases in diameter. Hence the *tela cellulosa* comes further outwards, along with the cortical vessels; and in all probability it is this *tela* which forms the epidermis so conspicuous in the birch, and which is divisible into layers, though not so early as the liber.

So many and peculiar modifications, which are all performed by peculiar organs, are brought into view during the growth of dicotyledonous plants; and yet shall it not be proper to distinguish these organs by peculiar names; and where so many operations are performed, shall we dare to ascribe the whole to nothing else than a long stretched *tela cellulosa*? And shall philosophers present us with this limitation of language as a new light thrown upon science? † It appears to me to be better, for the regular advancement of human knowledge, to allow the old names to remain, as they are in some measure known even to the common people, and are besides exceedingly useful and convenient.

That observers have often supposed they saw stretched out cells where vessels really existed, is exceedingly likely, as the partition walls of the vessels may approach very near in appearance to

* Most writers are of opinion that the *septa radiantia* come from the pith; but we do not see them standing closer in the stem near the pith than in the neighbourhood of the bark; and from recent observations it is evident that wherever a new septum appears, the two preceding ones, by diverging separate as far from it as they were before from each other. The *septa radiantia* exist in the wood, and are doubtless formed of the woody tubes.

† "We have to thank Sprengel and Mirbel that they first banished these vessels (*vasa lignea, corticalia, radiantia*) from physiology, and thereby threw a new light on the subject."—(Link's Additions to the Anatomy and Physiology of Plants, p. 17.)

stretched out cells: for, in the first place, it is very difficult to make a section completely parallel with the vessels, without cutting through a vertical wall; but where the tubes are cut through, they commonly assume the appearance of a transverse wall. In the second place, we may be easily deceived by air bubbles, the sides of which may assume the appearance of organic cross walls. In the third place, we cannot always conclude that there exists a perfect partition wall, where we believe we see it; for it may be only the two sides of the tube approaching each other, where a fold in the canal swells out the vessel itself. That, in fact, the cross walls are not always complete where they seem to be so appears to me to be proved by the *confervas*, in which we think we perceive true partition walls, and yet we see the green matter make its way from one articulation to another. All these considerations have induced me to believe in the existence of continued vessels wherever the sap clearly flows, even though anatomy should seem to decide to the contrary. That the sap, which flows with such impetuosity in the stem of a birch or maple, when it is punctured in the spring, should not proceed from open vessels, but from the so called small *vasa spiralia*, is quite incredible.* The absorption of coloured liquid by plants seems to establish my opinion; for the coloured liquor is confined to what modern physiologists have been pleased to call stretched out cells, and is not to be found in the *tela cellulosa*, though supposed a part of it. Who can in such a case believe that there are no vessels or continued canals?

These views and observations allow me to speak of the vessels of mosses, *algæ*, &c. Indeed, it appears to me a very partial proceeding to refuse vessels to these fine plants, which vegetate with such rapidity and vigour. In the *conferva elongata* very distinct canals or tubes may be observed below the bark. In the ribs of the leaves of leafy mosses we often speak of *ductuli*, and we mean by this word real vessels. In the *Jungermanniæ*, which grow so rapidly, and assume such beauty, vessels may be observed with the greatest facility: on that account I shall pass them over.

The causes why observers have been unwilling to recognise vessels in these plants, and likewise in the perfect plants, are the following:—They paid so much attention to the spiral vessels, that they conceived they must meet with something similar before they were at liberty to speak of vessels at all. It has an appearance of accuracy and precision not to speak of vessels unless they be as distinctly marked as the spiral vessels. But in a physiological point of view, the subject becomes darkened and imperfect. According to every analogy, we must give the name of *vessels* to those organs in which the sap flows, which nourishes the whole body; and those

* Dr. Afzelius has informed me that when the stem of the *tetracera potatoria* is cut, people can satisfy their thirst with the pure water contained in it. I have examined this wood microscopically, and find therein very large woody vessels, from which this water proceeds, and certainly no stretched out cells,

tubes, which carry a more local and less remarkable liquid, and which in the anatomy of animals are called *ducts*, as the *salivary ducts*, the *seminal ducts*, &c. In the anatomy of plants philosophers, without observing it, have nearly fallen into an abuse of language. That the spiral vessels nourish plants, is not very probable. They are exceedingly few, and often altogether wanting. In Guaiac wood we see very distinctly that the *false tracheæ* contain resin, which is not a substance that nourishes plants, but an excretion; but the true spiral vessels are only modifications of the *false tracheæ*, and other similar vessels situated in the wood. To attempt to draw a distinct line between them would be the same thing as in the human body not to admit the veins without valves to be real veins, but to constitute them a distinct class of vessels. The smallest stripe is sufficient to constitute a spiral vessel, and a false trachea members of quite a distinct system; and the *duct* lying hard by, where the cross stripe is distinct, is called a *lacuna*, as if it were altogether fortuitous. Here, where no different functions can be discovered, we abound in distinctions and names; yet we do not choose to distinguish the *woody*, *cortical*, and *radiating vessels*, in which distinct functions are very evident, from the general *tela cellulosa*.

On these grounds I call the fine canals containing nourishing sap, namely, the woody and cortical vessels, *true vessels*: and, on the contrary, name the larger canals, containing materials already brought to a state of perfection, *ducts*. So that in my language the spiral vessels become spiral ducts. However, I call Hedwig's *ductuli* in the leaves of mosses, &c. *vessels*, an expression by no means inconsistent with the old and more generally received names, but contrary to the new ones.

I shall now give a sketch of the different kinds of *ducts*, or rather point out the way in which these canals may be arranged.

The finer canals, namely, the woody vessels, carry thin, liquid, nourishing sap, to the cellular texture, as we have already seen. The more consistent and viscid sap, which approaches gum and resin in its nature, could not flow in so fine tubes. Therefore larger ducts have been constructed for them, which constitute a vascular system quite different from the system employed in nourishing the plant. But in order that this viscid sap may move freely, the walls of the vessels containing it could not be composed of a single thin membrane, but must be strong, and not liable to be torn. On this account they are wound round with spiral fibres, by the contraction of which the resinous sap is driven on, or at least prevented from accumulating. These spiral fibres, in young twigs and in herbs, in which no thick sap exists, are usually isolated, and run at a distance from each other. In the finest filaments, and other parts of the blossom, we find spiral vessels of the most delicate and beautiful structure, and no other larger ducts. In older parts of plants these spiral vessels grow together, and nothing more remains of their fine spiral structure than some cross stripes. They are then called *false*.

tracheæ. We can still perceive the cross stripes very distinctly in these ducts; for example, in guaiacum wood, in which pretty consistent resin is contained. In red sanders wood the cross stripes themselves in the false tracheæ are contracted, so that the red extractive is collected in grains. Their analogy with the spiral ducts in structure and functions cannot in this case be perceived. In older parts of plants the cross stripes are accumulated on the walls of the ducts; so that the whole assumes the appearance of a thick, confused web: and this is peculiarly the case in those places where greater strength is necessary, or where the thickest resin is to be conveyed along. In the tribe of pines observers have in vain searched for spiral ducts, and yet they constitute the trees richest in resin that we are acquainted with. A fine spiral duct would be speedily torn by the viscid liquid that moves in it; but nature always takes care to produce a stronger structure where uncommon resistance is necessary.

It appears to me very probable that the fine spiral ducts communicate at first with the woody vessels, and that when they proceed further they change into *false tracheæ*, from which new spiral ducts proceed, constituting a bundle; and that at last in the oldest parts of the plant the *false tracheæ* are changed into those large ducts called cylindrical *lacunæ*. These three ducts are usually found near each other lying in a bundle, and commonly so that the spiral ducts are nearest to the woody vessels. It is quite impossible, indeed, to demonstrate all this anatomically, as we cannot follow a single spiral vessel through a complete plant, or even a complete branch. I consider it as probable (and in the present case it is allowable to offer a bare probability) that in these vessels there is a kind of retrograde motion of the materials of plants: that the most recently formed resinous sap is contained in the uppermost and smallest twigs, where we find separate spiral ducts; and that it flows down slowly and gradually till we come to the thick resin in the roots. We see at least that the roots abound most in large ducts filled with resin.

From all this it appears very probable that the spiral ducts, *false tracheæ*, and cylindrical *lacunæ*, are gradations of the same series. On that account it would be proper to distinguish them by a general name. I have given to them all the common name of *ductus ligni*, or ducts situated in the wood; I call each of them separately *ductus spirales*, *subspirales*, &c. as subspecies. The name *ductus ligni* is simple, and I do not see why we should give complicated names to so very simple organs.

The part which the spiral ducts and their varieties perform in the wood is performed in the bark by other ducts of an equally simple nature. We find quite in the neighbourhood of the bundles of cortical vessels small ducts which contain a milky juice, and which I call *ductus guttiferi*.

In other plants the same ducts seem to pass towards the exterior *into larger canals*, which clearly lie in the *tela cellulosa*. In

our *pinus sylvatica* it is very evident that the smaller internal *ductus corticis* contain a thin resinous sap, which in the larger ducts acquires a thicker consistency. In the trees which contain a milky juice (*arborea guttiferæ*), as, for example, the *mammea Americana*, we perceive distinctly the fine ducts, as *vasa guttiferæ*, but the larger resiniferous ducts do not present themselves. In like manner the lactescent plants seem to have only finer *ducts*, which appear scarcely to differ from the cortical vessels themselves. On that account I have spoken of them distinctly from the *ductus guttiferi*, as a variety of the *cortical ducts*. But that the milky juice, especially in the bark, comes from such ducts, is to me very evident.

Whether all the ducts of the bark, even though they may contain the same materials with the ducts of the wood, are yet always destitute of every trace of spiral fibres, is a point that cannot be determined with precision. They certainly always lie on the outside of the bundle of cortical vessels; (and not in that bundle itself as the *ducts of the wood* do). Perhaps there were not materials there for such spiral fibres, which in the ducts of the wood may have some analogy with the vessels or fibres of the wood itself. The cortical ducts lie always in the *tela cellulosa*, and probably their walls are composed of that matter, and not of fibres. These considerations induced me to give them the name of *cellular ducts* (*ductus cellulosi*), especially as some similar canals present themselves in the pith. Perhaps it would have been better to have called them *ductus corticis*. Their different layers, and their peculiar structure probably proceeding from that circumstance, show us that the system of the bark in dicotyledonous plants is always distinct from the system of the wood, although both show a strong analogy to each other. The reason why nature has placed the cortical ducts on the outside of the bundles of vessels is probably that in such a position it is less injurious to the plant if they happen to be ruptured, and that they can stretch with more facility to admit an increase of matter.

Yet to affirm with certainty that all these things are so, is quite impossible. When we have a great object before our eyes, we must not be stopped by small difficulties, otherwise we shall be exhausted before the object is attained.*

* Dr. Wahlenberg, at the reading of this paper, exhibited to the Society various preparations of slips of wood and bark, in which the different vessels could be distinctly seen with a glass, and still better by means of a compound microscope. (Note of the society entitled Friends of Natural History in Berlin.)

ARTICLE V.

Analysis of Rice. By M. Henri Braconnot, Professor of Natural History, Director of the Garden of Plants at Nancy, &c.*

As rice has not hitherto been analyzed, and as it is one of the most important grains, since it serves for food to a great part of the human species, I thought it worth while to subject it to some experiments.

Parmentier appears to me the only person who has made some experiments on rice. † His results induced him to consider it as a peculiar substance, which he placed between starch and gum, doubtless on account of its horny translucency, and the difficulty of reducing it into a powder, which has neither the fineness, the creaking sound, nor the feel of starch, and which falls quickly to the bottom when diffused in water. But we shall find that this species of grain is more complex than had been supposed.

Action of Water on Rice.

A hundred grammes of Carolina rice, unground, lost by drying five grammes of humidity. They were then macerated with water at the temperature of 122°. The grains absorbed the water with avidity, and almost at the same time split by several transverse sections, which did not happen nearly so quickly if the rice had not been previously well dried. These grains, thus split, were easily squeezed between the fingers into a very fine powder. They were pounded in a glass mortar, adding to them in successive portions the liquid in which they had been macerated. Thus a milky liquid was obtained, which was thrown upon a filter. The greatest part of the substance of the rice remained upon the filter. Being well washed in water, in order to take up every thing soluble, and then dried, it weighed 93·67 grammes. The water in which it was washed was set aside for examination. These 93·67 grammes, when diffused through water, passed completely through a silk seirce; but the milky liquid contained at least two distinct substances: the one, very white, constituting about two-thirds of the total weight, remained for some time suspended in the liquid; the other, less white, was specifically heavier. It was easily separated from the first substance by the affusion of a great quantity of water, and by repeatedly decanting off the emulsive liquid. This liquid in a few days let fall a very white deposite, which had acquired a kind of density by the approach of its particles to each other. When dried, it was of a brilliant white, light, and was easily reduced to an impalpable powder, which adhered readily to the fingers, and emitted a particular sound when pressed.

* Translated from the *Ann. de Chim. et Phys.* iv. 370, April, 1817.

† *Ann. de Chim.* xl. 33.

This powder, being triturated with water and a little iodine, produced a colour of a beautiful dark blue, as would have been the case with starch. It dissolved in boiling water; and, when cooled, formed a tremulous and semitransparent jelly, exactly similar to starch.

If we boil one part of this same powder with 4000 parts of water, and filter the liquid after cooling, it passes as limpid as water. When lime-water or barytes-water is added to it, a white floccy precipitate is gradually formed. Infusion of galls likewise occasions a slight precipitate. Common starch, treated in the same way, gave a similar result. This shows that, when boiled, it is to a certain extent soluble in cold water, and that the above-mentioned re-agents are capable of detecting minute quantities of it.

This constituent of rice, then, was obviously starch.

As for the other heavier substance, which was first deposited, it was composed of a great proportion of starch united to a vegetable matter and to a parenchyma. We shall examine it immediately.

Examination of the soluble Matters which Water separates from Rice.

The water employed to deprive the 100 grammes of rice of every thing soluble was acid, and reddened paper stained with litmus. Suspecting that this uncombined acid might be of the nature of vinegar, the water was distilled in a glass retort. The produce, being mixed with a small quantity of barytes-water, and then evaporated to dryness, left only a slight residue; but from which weak sulphuric acid disengaged the odour of acetic acid.

During the distillation the liquid in the retort became muddy, especially towards the end, and there was collected a fine white powder, which did not seem to be albumen. The liquid, with its sediment, was evaporated to dryness in a small porcelain capsule. There remained a tolerably dry residue, of a pale yellow colour, slightly attracting humidity, and weighing 1.28 gramme. It was treated with a small quantity of warm water, to give it the consistence of a syrup. Then alcohol was poured into it. A copious deposit was obtained, which, assisted by a gentle heat, was collected into a mass, having a gummy appearance, which could be readily kneaded between the fingers, and which was easily dried. It weighed 0.99 gramme.

The alcohol which had precipitated this matter, being evaporated by a gentle heat, left 0.29 gramme of a syrupy residue, having but little colour, very difficult to dry, with a sweet taste, and the smell of honey, attracting humidity, like uncrystallizable sugar, but little soluble in alcohol, and burning vividly, with the odour of caramel.

I had presumed that this saccharine matter contained acetate of potash, which contributed to render it deliquescent. But it appears to retain only traces of muriate of potash; for, having poured sulphate of silver into the solution, a slight precipitate of chloride of

silver fell. The liquid, being evaporated, and then treated with phosphoric acid, did not give out the odour of acetic acid.

The apparently gummy mass precipitated by alcohol, and weighing 0.99 gramme, being digested in cold water, dissolved entirely, with the exception of a white flocky matter, which was separated by the filter, and which, when well dried on the filter, was found to weigh 0.13 gramme, and to preserve its white colour. A small quantity of this matter being put into a glass tube shut at one end, was exposed to a heat sufficient to occasion a commencement of decomposition. Litmus paper reddened by an acid, being plunged into the air of the tube, recovered its blue colour. The charcoal of this matter, being incinerated, left a notable quantity of phosphate of lime. It did not dissolve in boiling distilled vinegar, nor in diluted muriatic acid. A weak solution of potash, heated slightly with this substance in a silver capsule, did not seem to dissolve it. Black dots were formed, owing obviously to the presence of sulphur. This substance possesses the characters of a vegeto-animal matter. I shall return to its properties when I examine the action of diluted sulphuric acid on rice.

The gummy solution, after being separated from the matter just described, appeared still to retain some traces of it; for it was not perfectly transparent, and had an opalescent aspect. It contained phosphate of lime, which ammonia precipitated, and which was probably kept in solution in consequence of the presence of a little acetic acid. It appeared likewise to retain traces of phosphate of potash; for if, after having precipitated the phosphate of lime, we add to the liquid saturated with ammonia a little muriate of lime or sulphate of iron, a new precipitate of phosphate gradually falls.

To separate these substances from the matter apparently gummy, acetate of lead was poured into its solution. The resulting precipitate, being decomposed by sulphuric acid, furnished an uncrystallizable acid mixed with vegeto-animal matter. A portion of this acid, being heated, left a charcoal which, when exposed to the action of the blow-pipe, left a pretty large globule of glassy, limpid phosphoric acid. Another portion of the same acid, saturated with potash, and exposed to heat, left an alkaline residue, which indicates slight traces of a combustible acid.

Into the liquid separated from the precipitate produced by the acetate of lead, carbonate of ammonia was poured. The liquid was then filtered, and evaporated to dryness. There remained 0.71 gramme of a matter very little coloured. It was transparent, shining, had a vitreous fracture, and all the appearance of gum, though not quite the insipid taste of that substance.

When put upon a red-hot coal, it swells, and emits the smell of burned bread. When distilled, it yields an oil, and a considerable acid product, which did not appear to me to contain ammonia. However, the infusion of nutgalls precipitated the solution of this gummy matter in water. It was precipitated also by lime-water in *large flocks*, soluble in distilled vinegar. Barytes-water likewise

throws down a flocky precipitate from it. Acetate of lead occasions no change in it; but the subacetate of lead and the protonitrate of mercury occasioned slight precipitates.

Although this matter has quite the external appearance of gum, its chemical properties appear to me to show it to be more nearly related to starch. It is true that it is easily soluble in cold water, and that starch is not so, at least in its ordinary state; but we know that it becomes soluble when it has undergone a slight modification; and I have ascertained that the gummy matter, soluble in water, obtained from starch slightly roasted, has much analogy with the gummy matter of rice. Like this last, it was precipitated from its solution by tannin, lime-water, and barytes-water, but not by acetate of lead; and besides, when distilled, it furnished a product which contained no ammonia.

This gummy matter approaching to starch exists probably in the greater number of grains which contain this latter substance.

Action of diluted Sulphuric Acid on Rice: Separation of the Starch, of the Parenchyma, and of the Vegeto-animal Matter.

From what we have said above, it appears that rice, when well dried, and plunged into warm water, becomes so soft that it may be easily crushed to pulp, and that, when triturated with water, it forms a milky liquid, which yields two deposits; one of which, and the most considerable, is starch; the other heavier, and having another tint, contains likewise a great deal of starch, besides a vegeto-animal matter attached to the parenchyma, from which it was difficult to separate them, on account of its great subdivision. To accomplish this object, and to determine the respective quantities of these matters, 100 grammes of Carolina rice, unbroken, were macerated in water of the temperature 122° , after having been dried. They were then boiled for about half an hour in water acidulated with sulphuric acid. The amylaceous matter was dissolved, and the parenchyma remained in membranes or flocks floating in the liquid, and were separated from it by passing it boiling hot through a fine linen cloth. On cooling, it allowed a matter to fall having the aspect of a semitransparent jelly, and which was separated by passing the liquid through a filter. This acid liquid, which contained the starch, being boiled for some hours, and treated in the proper manner, furnished a syrup, which gradually consolidated into a mass of sugar.

The gelatinous matter remaining on the filter was bulky. Being washed with a considerable quantity of water, and then dried, it weighed 3.6 grammes, and had the semitransparence of horn. When boiled with water, it swelled, but did not dissolve, at least in a perceptible manner. However, the liquid was slightly precipitated in white flocks by the infusion of galls. When gently heated in a silver capsule, with a solution of potash, the vessel became quite black, as if a sulphuret had been poured into it. Diluted ammonia, being macerated at a gentle heat on this sub-

stance, dissolved it readily without decomposing it. When an acid is poured into the solution, the substance is again thrown down abundantly, but no odour of sulphureted hydrogen is disengaged.

Diluted muriatic acid, being boiled with the same matter, dissolved a very small portion of it, which was precipitated by ammonia. The insoluble matter separated from the acid liquor, and well washed with hot water, then boiled in that liquid, dissolved entirely, forming, it would appear, a neutral muriatic compound, very permanent. It was not affected by ammonia; but an excess of muriatic acid occasioned a considerable white deposite. The supernatant liquor was limpid, like water.

When distilled, it furnished a great quantity of yellow concrete oil, a slightly alkaline liquid, which restored the blue colour to litmus paper reddened by an acid, and which contained hydro-sulphuret of ammonia; for acetate of lead formed in it a brown precipitate; but no carbonate of ammonia sublimed from it.

From the properties of this vegeto-animal matter, we see that it is the same which was obtained, though in small quantity, from the water in which rice had been washed. It differs only from this last in containing no sensible quantity of phosphate of lime. It contains less azote than gluten and albumen.

I return to the parenchyma of the rice which remained upon the linen cloth. It was of a dull white, like cheese, and could be kneaded between the fingers without adhering to them. When dried, it weighed 4·8 grammes, and had preserved its white colour. It was indeed somewhat semitransparent, owing to the presence of an oily matter, which penetrated it. This was particularly the case with the parenchyma of Piedmont rice.

When this matter is set on fire, it burns with a pretty regular flame, in consequence of the oily matter which it contains. It emits the odour of burning bread, and leaves a charcoal, irreducible even at a great heat, which preserves the same dimensions as the substance employed.

When distilled, it gives a great deal of oil, an acid product which contains ammonia, and sulphureted hydrogen; for a paper impregnated with acetate of lead, when plunged into the air of the receiver, becomes black.

When boiled in a solution of potash, it is dissolved. The liquid, when agitated, exhibited undulations, occasioned by a very fine pearly-looking matter which floated in it, as is the case with a solution of soap. A plate of silver, when plunged into this liquid, became brown. Acids formed in it a white curdy precipitate, and occasioned the formation of the odour of sulphureted hydrogen gas. This matter appeared then to contain sulphur. It is possible, however, that the sulphur might have been produced, in part at least, by the vegeto-animal matter retained by the parenchyma; for if we macerate this last in ammonia, a small quantity of the animalized matter is dissolved, which may be precipitated by an acid.

Concentrated sulphuric acid has little action on this substance

cold. When heated, it chars it, with a slight disengagement of sulphurous acid.

Nitric acid dissolves it entirely, when assisted by heat. The products are oxalic acid, malic acid, yellow bitter principle, and a slight yellow sediment.

When iodine is triturated with this substance moist, it communicates a yellowish-green colour. When macerated in the infusion of nutgalls, it unites with tannin, and assumes a fawn colour. When steeped in water, and left to itself, it becomes covered with mucors. From the properties of this parenchyma of rice, it appears to be different from the woody fibre. It seems to be less oxygenated than starch; and it is probable that it partakes with starch the nutritive properties which are known to exist in rice.

Action of Alcohol on Rice.

A hundred grammes of Carolina rice macerated in water were triturated, and well diffused through that liquid. The milky liquor was then filtered. What remained upon the filter, after being washed and dried, was macerated in alcohol for 24 hours. It was then heated and filtered. After being repeatedly washed in alcohol, these liquids were mixed together, and distilled. To obtain the greatest part of the alcohol, the evaporation was conducted at a low heat. A substance remained, which, being redissolved in alcohol, furnished 0.13 gramme of a fixed oil, almost colourless, having a rancid odour and taste, and the consistence of olive oil half congealed; but, when exposed to cold, concreting into a crystalline substance, which separated from it, and which dissolved readily in cold alcohol and in alkalies.*

Distillation of Rice.

A hundred grammes of rice subjected to distillation furnished a brown, thick oil, in small quantity; an empyreumatic liquid, strongly reddening paper stained with litmus, containing acetic acid, and doubtless a little ammonia, but which could not be rendered sensible to the smell when the acid liquor was triturated with quicklime. The gaseous produce was neglected. It contained sulphureted hydrogen; for paper dipped in acetate of lead, being plunged into the air of the receiver, was covered with a coat of sulphuret of lead. The charcoal remaining in the retort weighed 22 grammes. It had a metallic aspect, was light, porous, and in a single mass. It was harder than common charcoal, and formed, with difficulty,

* It is the general opinion that expressed oils are found only in a small number of grains, called, on that account, *oily*; but it appears that they exist essentially in all, and the list of plants from whose seeds oils may be pressed is very extensive. Numerous trials have satisfied me that the seeds of most dicotyledonous plants are in this predicament. I may cite all those of the family of borraginæ, dipsacæ, solanæ, labiæ, chicoracæ, cynarocephalæ, corymbifera, papaveracæ, cruciform, the greatest part of the ranunculacæ, urticæ, cucurbitacæ, onagræ, siliariæ.

traces on paper. When well washed in boiling water, it only communicated to that liquid imperceptible traces of alkali.

When exposed to a strong heat, it could not be incinerated. When treated in a crucible with potash, it gave some indications of the presence of a cyanide. This charcoal was almost completely burned by means of nitre. The alkaline mass was dissolved in water, and an excess of muriatic acid poured into it. Ammonia was then added to the filtered liquid, which produced a precipitate weighing 0.4 gramme. It was phosphate of lime; for when dissolved in a little nitric acid, the subacetate of lead occasioned a precipitate, which, when well washed, was fused before the blow-pipe into a crystallized bead of phosphate of lead. Subcarbonate of soda being added to the liquor from which the phosphate of lime had been precipitated by ammonia, precipitated, when assisted by heat, about three centigrammes of carbonate of lime.

The ashes of rice, then, consist almost entirely of phosphate of lime. On appreciating as exactly as possible the results of the comparative analyses of Carolina and Piedmont rice, I consider the approximate constituents of each to be as follows:—

	Carolina Rice.	Piedmont Rice.
Water	5.00	7.00
Starch	85.07	83.80
Parenchyma	4.80	4.80
Vegeto-animal matter	3.60	3.60
Uncrystallizable sugar	0.29	0.05
Gum approaching to starch	0.71	0.10
Oil	0.13	0.25
Phosphate of lime	0.40	0.40
Muriate of potash	} Traces	} Traces
Phosphate of potash		
Acetic acid		
Vegetable salt with base of lime		
Ditto with base of potash		
Sulphur		
	100.00	100.00

ARTICLE VI.

Memoir on the Sodalite of Vesuvius. By M. Le Comte Stanislas Dunin Borkowski.

(Presented to the Academy of Sciences, Oct. 28, 1816.)

M. Ekeberg was the first who analysed a mineral from Greenland which contains 25 per cent. of soda. Dr. Thomson repeated this analysis, gave a mineralogical description of the mineral, and

made it known in his excellent memoir as a new species, under the name of *sodalite*.* No other locality of sodalite has hitherto been observed; but I have been lucky enough to find it on the slope of Vesuvius, called *Fosso Grande*, which may be fairly considered as the great repertory of the volcanic riches of Vesuvius. Sodalite appears due to the ancient eruptions, which have furnished mineralogy with nepheline, meyonite, and idocrase; but it is very far from being so common as these species. This is no doubt the reason why it had not been observed by the skilful observers who have examined that celebrated country. Notwithstanding considerable search, I could meet with only a single specimen on the spot. Another was afterwards given me by the guide Salvatore. The following observations were made upon these two specimens:—

External Characters.

The sodalite of Vesuvius is greyish-white. It occurs in round grains, and crystallized in the form of six-sided prisms, terminated in a point by three faces placed alternately on the lateral edges. The crystals vary in size, and I possess one which is an inch long. The surface of the crystals is smooth, and rather iridescent.

External lustre shining, resinous. Internal lustre vitreous. Cross fracture perfectly conchoidal; principal fracture foliated; but it is difficult to determine the cleavage. Translucent. Fragments indeterminate; sharp edged.

It is semihard, yielding readily to the file; easily frangible. Specific gravity, 2.89.

Chemical Characters.

The fragments of the sodalite of Vesuvius, when put into nitric acid, do not lose their lustre while in the acid; but after they are taken out, they soon become covered with a whitish crust. When put in powder into muriatic acid, they form a jelly. Before the blow-pipe, it melts, without addition, but with difficulty.

Position.

The sodalite is found in calcareo-talcose quangué, accompanied by pyroxene, green pumice, and a substance crystallized in small six-sided tables, called by Werner *icespar*.

The mineralogical characters which I have just given presented an unknown substance; but they were far from ascertaining its real nature. Nor could crystallography serve to determine the species; for the form of the crystals, being a six-sided prism, terminated by three-sided pyramids, with angles of 120° , gave for a primitive form the rhomboidal dodecahedron; but this primitive form, being

* This statement would require some correction. When I made my analyses, I was not aware that the mineral had been examined by Ekeberg. Ekeberg, I believe, never published any thing on the subject. He merely sent the numerical account of his analyses to Mr. Allan, in whose possession I saw it.—T.

common to several different species, ceases on that account to be distinctive. It was necessary, therefore, to have recourse to chemistry; and the result of my analysis completely answered my intention.

Chemical Analysis.

A.—25 decigrammes of sodalite in fragments were kept at a cherry-red heat in a platinum crucible for half an hour, without losing any weight. They became milky in their aspect. The angles which touched the sides of the crucible had undergone a commencement of fusion.

B.—1. 4 grammes of sodalite reduced to a fine powder were mixed with 10 grammes of muriatic acid diluted with five parts of distilled water. The stone was attacked in the cold. On a gentle ebullition, the solution assumed the form of a stiff yellow jelly, which I collected with much care upon a porcelain capsule, and evaporated the whole to dryness. Towards the end of the evaporation, care was taken to stir the jelly, that the drying might be gentle and equal. When the whole was reduced to powder, it was diluted with water, and the residue washed till the liquid ceased to affect nitrate of silver. This residue, being heated to redness, weighed 17·25 decigrammes. The filter had increased in weight 0·25 decigrammes, which makes the total weight of the residue 17·5 decigrammes.

To convince myself that this residue was silica, I heated it for half an hour, with five grammes of caustic potash, in a silver crucible. The mixture fused; and, being taken from the fire, I poured distilled water on it while still hot. When well diffused through the water, I poured muriatic acid on it, which dissolved it completely. This solution was evaporated to dryness. The silica obtained, after being washed and heated to redness, weighed 17 decigrammes. The loss of 0·5 decigramme was owing to not having weighed the filter; for the liquid employed to wash it was neither precipitated by caustic ammonia nor by carbonate of ammonia.

2. The acid liquid from which the silica had been separated was precipitated by pure ammonia. A very white, bulky matter was obtained, which was separated by the filter. After being washed, it was boiled, while still moist, in caustic potash. The whole was dissolved, except a little brown matter, which was separated by the filter. The alkaline liquor being neutralized by muriate of ammonia, a copious precipitate fell, which, after being washed and heated to redness, weighed 6·75 decigrammes. It possessed all the properties of alumina.

3. I poured carbonate of ammonia into the liquid from which the alumina had been separated. Next day I found a precipitate, which, having been washed and heated to redness, weighed 2·75 decigrammes. The residue dissolved in sulphuric acid was evaporated to dryness, and treated with cold water, which dissolved the whole. This solution was concentrated by evaporation, and set aside

for spontaneous crystallization. As it refused to crystallize, and had not the taste of sulphate of magnesia, sulphate of potash was added to it, on which crystals of alum were formed. The precipitate obtained by the carbonate of ammonia was, therefore, alumina, which must be added to the sum obtained by the preceding experiment.

4. As there was a matter attached to the rod from which the 2·75 decigrammes of alumina were obtained, I poured muriatic acid on it, in order to obtain this matter. Brilliant scales were detached, which, when collected on the filter, and dried, had so strong a resemblance to boracic acid, that I thought at first that I had obtained that acid; but I soon satisfied myself that it was silica. It weighed 0·25 decigrammes.

5. The brown deposit of the second experiment, which weighed 0·25, was treated with sulphuric acid, which dissolved the iron without touching the silica. The iron, being precipitated from the solution by ammonia, weighed 0·05 decigramme. This metal exists in such a minute proportion, that I think it belongs rather to the green pumice than to the sodalite. The 0·2 decigramme not attacked by the sulphuric acid possessed the characters of silica.

6. The silica, alumina, and iron obtained, not amounting to the weight of the stone analyzed, it was necessary to seek for the other constituents in the liquid from which the earths had been separated by the carbonate of ammonia. The liquid, in consequence, was concentrated; sulphuric acid was added, to drive off the muriatic acid, and convert the same into sulphate. It was then evaporated to dryness, and exposed to a red heat, to drive off the sulphate of ammonia and the excess of sulphuric acid. The matter obtained weighed 22·5 decigrammes. It was dissolved in water; the solution was concentrated, and set aside. Some needle-form crystals of sulphate of lime were deposited; but the quantity was so small that they cannot be estimated. The liquid had crystallized confusedly in small crystals; and as it precipitated the solution of platinum, I thought at first that it was sulphate of potash. But when the crystals were redissolved, the liquid furnished, by spontaneous evaporation, six-sided prisms, which effloresced in the air, had a cooling taste, and did not precipitate platinum. They had, therefore, all the characters of sulphate of soda; and as the sulphate of soda obtained by calcination weighed 22·5 decigrammes, it contained 11 decigrammes of pure soda. The precipitate obtained by the platinum solution is owing to the presence of a small quantity of potash which is mixed with the soda.

The mineral analyzed, then, consists, supposing it to be 40 parts, of the following ingredients:—

Silica	17.95
Alumina	9.50
Iron	0.05
Soda with a little potash	11.00
Loss	1.50
	<hr/>
	40.00

Or, supposing 100 parts, of

Silica	44.87
Alumina	23.75
Soda with a little potash	27.50
Iron	0.12
Loss	3.76
	<hr/>
	100.00

The great quantity of soda which I obtained made me immediately suspect that the substance analysed was a sodalite. This suspicion was confirmed when I compared my analysis with those of Ekeberg and Thomson. The following table exhibits their results:—

	Ekeberg.
Silica	36
Alumina	32
Soda	25
Muriatic acid	6.75
Oxide of iron	0.25
	<hr/>
	100.00

	Thomson.
Silica	38.52
Alumina	27.48
Soda	23.50
Muriatic acid	3
Oxide of iron	1
Lime	2.70
Volatile matter	2.10
Loss	1.70
	<hr/>
	100.00

These analyses differ from mine merely in my having found a little potash mixed with the soda. The loss of 3.76 which I had in my analysis corresponds with the three parts of muriatic acid obtained by Dr. Thomson, which it was impossible for me to perceive, as I had employed that acid in my analysis. The external characters of the sodalite of Greenland do not differ essentially from those which I observed in the sodalite of Vesuvius; for the six-sided

prism terminated by three-sided pyramids, with angles of 120° , is merely an elongated form of the rhomboidal dodecahedron, which the Count Bournon ascertained to be the primitive form of sodalite. As to the property of forming a jelly with acids, though it was not remarked by Dr. Thomson, it was recognized by M. Haiiy.

Now that the existence of sodalite on Vesuvius is known, it will be easy to distinguish it by its mineralogical characters from the other species which occur on the same mountain.

The substance with which the sodalite may be most easily confounded, when it occurs in grains, or massive, is amphigene; but it may be distinguished by its property of forming a jelly with acids, by its being fusible, and softer than amphigene.

Geological Views.

The discovery of sodalite on Vesuvius is interesting likewise to geology. After the numerous discoveries that have been made there, it appears to me evident that the substances thus found are the produce of fire; for it is impossible for me to conceive that species so different as nepheline, meyonite, idocrase, amphigene, pyroxene, garnet, amphibole, spinell, and others, should occur together ready formed at the bottom of the crater, as in a magazine, to be thrown out of the volcano. The sodalite of Vesuvius has very much the character of fusion; for in the specimen which I possess it is surrounded with pumice, which is known to be the produce of fire. The sodalite of Greenland, on the contrary, occurs in primary formations, accompanied by felspar rocks, and leaves no doubt respecting its neptunian origin. Thus we have two substances found at the two extremities of Europe formed by two different ways, which yet by their composition and mineralogical character are identic, and constitute the same species. From this it follows that it is impossible in geology to prove the volcanic or neptunian formation of a species by simply examining the external characters; for these are common to the two ways of formation. To arrive at satisfactory results respecting the formation of rocks, we must study their geological relations. It is thus that nature herself seems to have traced the grand limits which separate geology from mineralogy.

ARTICLE VII.

Chemical Examination of a Quantity of Sugar supposed to have been intentionally poisoned. By John Gorham, M.D. Member of the American Academy, and Professor of Chemistry in Haward University, Massachusetts,

IN February, 1817, I received from Dr. Nichols, of Kingston, in this state, about two drachms of common brown sugar, together

with a letter, in which he remarked, "I was called to-day to visit in a family, of which every member, except one,* was suddenly taken sick, puking every thing swallowed; and they considered it to arise, and circumstances favoured the supposition, from eating the sugar, of which I send you a sample."

On inspecting the sugar, small white grains or particles could be observed disseminated through the mass; and, upon tasting a little of it, a peculiar acrid impression was left for some time on the tongue.

In order to separate this substance, the mass was put into a common jelly glass, which was afterwards nearly filled with distilled water, and the liquid was agitated with a glass rod until the whole of the sugar was dissolved. On allowing the solution to remain at rest for a few minutes, a white ponderous powder was first deposited, after which there followed a lighter precipitate of a grey colour. When nearly the whole of the insoluble part had been separated, the liquid was poured on a filter, the remaining solid was washed with repeated portions of distilled water, which were preserved, and the solid matter was collected and dried. Its colour was a dirty white, and weighed $1\frac{1}{4}$ grain; but perfectly white particles could be perceived in it, and the shade of colour was owing to the impurities of the sugar. These might amount to one-fourth of a grain; so that the white substance obtained may be estimated at one grain. It was divided into eight parts; and, for the sake of greater precision and convenience, these parts were respectively marked No. 1, 2, 3, &c.

My first object was to ascertain whether this powder consisted of, or contained, arsenic.

EXPER. I.—No. 1 was put into a watch-glass, with one-third of a grain of pure solid potash; 20 drops of distilled water were added, and the whole was boiled to dryness. Upon the solid mass were poured about 20 drops of distilled water; by agitation, the greatest part was dissolved, but the solution was turbid. On allowing it to stand for a time, a greyish powder subsided, and the clear liquid was decanted. One drop of this solution added to a solution of sulphate of copper in water produced a distinct precipitate of a *grass-green* colour. When added to the amount of six drops, the precipitate was abundant. The solution of sulphate of copper, although not saturated, was of considerable strength.

EXPER. II.—One-eighth of a grain of powdered arsenic of commerce was mixed with one-third of a grain of solid potash, and treated in the same way, viz. by mixture with water, boiling to dryness, and subsequent solution in 20 drops of distilled water. One drop of this solution added to another portion of the same solution of sulphate of copper, immediately occasioned a *grass-green* precipitate; six drops afforded a copious deposition; and the colour and

* This individual eat no sugar.

appearances of this precipitate so closely resembled those of *Exper. I.*, that the eye could distinguish no difference between them.

EXPER. III.—About a drachm of solution of nitrate of silver was poured into a glass; one end of a clean glass rod was dipped into a solution of pure ammonia recently prepared, and the drop adhering to it was brought into contact with the nitric solution; the other end of the rod was then immersed in the liquid prepared as in *Exper. I.*, and afterwards made to touch the surface of the solution of silver, a dense *yellow-coloured* precipitate was immediately formed. When three or four drops of the above-mentioned liquid were added to the solution of nitrate of silver, the precipitate was considerable.*

EXPER. IV.—The same quantity of solution of nitrate of silver being poured into another glass, a drop of liquid ammonia was added, and afterwards a drop of a solution known to contain arsenic and potash, or arsenite of potash. A dense *yellow-coloured* precipitate instantly took place, precisely similar in every respect to that produced in *Exper. III.*

EXPER. V.—The *yellow-coloured* precipitate, *Exper. III.*, was collected on a filter, repeatedly washed with distilled water, dried, mixed with thrice its volume of charcoal, and put into a small and thin glass tube closed at one end, the mouth being obstructed with a roll of paper. The part of the tube containing the materials was held in the flame of a spirit lamp; it soon became red-hot, and was kept in that state for the space of 10 minutes. When cooled, no metallic film could be perceived; but the internal surface of the tube, about an inch from the extremity, which had been heated, was found to be coated with a *white crystalline*, and apparently *granular sublimate*.

EXPER. VI.—The *yellow-coloured* precipitate, *Exper. IV.*, being increased in quantity by the addition of a few drops each of ammonia and of the arsenical solution to the solution of nitrate of silver, was managed precisely as stated in *Exper. V.* When the tube was taken from the lamp and cooled, there was no appearance of a metallic film; but the internal surface exhibited a *white, crystalline*, and apparently *granular sublimate*.

EXPER. VII.—No. 2 of the white powder was mixed with about three times its weight of charcoal powder; the mixture was put into a thin glass tube about a line in diameter, and hermetically sealed at one end. Its mouth was closed with a roll of paper. The extremity containing the mixture was immersed in the flame of a spirit lamp; it soon became red-hot, and was continued in that situation about 10 minutes. After being cooled, its internal surface, half an inch from the sealed end, was found to exhibit a distinct *metallic film* of a *bluish colour*.

* An alkali being present in the liquid prepared from No. 1, the addition of ammonia was perhaps superfluous, but this circumstance did not occur to me until after the experiment.

EXPER. VIII.—One-eighth of a grain of arsenic of commerce was mixed with thrice its weight of powdered charcoal, and put into a glass tube, similar to the one above-mentioned; it was exposed in the same way, and for the same length of time, to the heat of a spirit lamp. After the experiment, its internal surface exhibited a *metallic film* of a *bluish colour*; and if any difference were perceptible between this and that of Exper. VII., the latter was rather more distinct.

EXPER. IX.—No. 3 was put into a watch-glass, 20 drops of pure muriatic acid were added, and they were exposed to heat until the greatest part of the powder was dissolved. A greyish powder remained, which appeared to consist of the impurities of the sugar. The quantity was too minute to admit of a satisfactory examination, and I did not think it essential. A watery solution of sulphureted hydrogen was then made; and a few drops of this solution being added to the muriatic solution, a *straw-coloured* precipitate was immediately formed. When this substance was collected, dried, and exposed on a small spatula of platina, to the heat of a lamp, it first turned red, appeared to undergo fusion, exhaled a sulphureous odour, and was entirely dissipated in vapour.

EXPER. X.—The eighth of a grain of powdered arsenic of commerce was dissolved in muriatic acid; solution of sulphureted hydrogen being then added, a *straw-coloured* precipitate was instantly produced, which, when dried, and exposed to heat, turned red, melted, exhaled a sulphureous odour, and passed off in vapour, leaving no residuum.

A fragment of native orpiment, or the yellow sulphuret of arsenic, was heated on a blade of platina: it assumed a red colour, melted, gave out a sulphureous odour, and was completely vaporized.

EXPER. XI.—No. 4 was taken on the point of a penknife, and held over the flame of a lamp; a white vapour was soon perceived to rise, having the peculiar alliaceous odour which has been supposed to characterize arsenic and its oxide in the elastic form.

No. 5 was unfortunately lost in an attempt to form arsenic acid. It was immersed in nitric acid contained in a glass capsule; but on exposure to heat in a sand-bath, the glass broke, and the materials were lost in the sand.

The object in obtaining arsenic acid was to form arseniate of silver, by adding it to an ammoniacal solution or nitrate of silver.

EXPER. XII.—No. 6 was mixed with twice its weight of powdered charcoal; the mixture was put between two polished plates of copper, which were secured by iron wire, and exposed to a dull red heat for a few minutes. When cold, the plates were separated, and a white mark, or, in other words, a white alloy, was visible on each plate, on the surface which had been in contact with the mixture.

EXPER. XIII.—An eighth of a grain of white oxide of arsenic

was mixed with twice its weight of charcoal powder; the mixture was put between two similar plates of copper, and exposed to a dull red heat. The results were found to be the same as in Exper. XII.

Nos. 7 and 8 were expended in repeating the first, third, and fifth experiments. The phenomena resulting from them were precisely the same as are there detailed, and the conclusions which may be drawn from them were amply confirmed.

Observations.

The results of the experiments above stated are unequivocal. The white matter mixed with the sugar exhibited all the characters of the arsenic of commerce, the white oxide, or arsenious acid of chemists. This fact is demonstrated by the first, third, fifth, and seventh experiments; but having a sufficient quantity of the powder to go through with an extensive series, I also performed those which may be considered as of more doubtful character, such, for example, as the whitening of copper, the odour exhaled by exposing the substance to heat, and the formation of orpiment, or the yellow sulphuret of arsenic, by sulphureted hydrogen and the muriatic solution.

The action of arsenious acid on the salts of copper has been known from the time of Scheele, and his name has often been given to the green precipitate or pigment produced in this experiment. It appears to be a delicate test of the presence of arsenic, and is not, I believe, liable to any material objection. The test of Dr. Marcet is equally delicate; but any alkaline phosphate, and even phosphoric acid alone when ammonia is present, will produce a yellow-coloured precipitate in solution of nitrate of silver; and it is, therefore, necessary to investigate the properties of this insoluble substance, in order to ascertain whether it be phosphate or arsenite of silver. This circumstance may sometimes render the use of this test inconvenient; and where the quantity obtained is very small, even doubtful, from the impossibility of arriving at accurate results in examining minute portions of matter. Still if the same substance should not only occasion this precipitation in solution of nitrate of silver, but also the formation of Scheele's green in solution of sulphate of copper, no doubt can be entertained respecting its nature. According to Dr. Marcet, the phosphate of silver yields no smoke, nor crystalline sublimate, when heated in a tube; and when urged before the blow-pipe on charcoal, it forms a greenish-coloured and difficultly fusible globule.*

The arsenite of silver, with the exception of colour, is characterized by very different properties. It grows brown on exposure to light; it is soluble in nitric acid, and in excess of ammonia; it is decomposed by heat; and, when the process is conducted in a tube, a white vapour ascends, which condenses on the colder part in the

* *Medico-Chir. Trans.* vol. vi. p. 663.

form of minute octohedral crystals.* It is this decomposition which Dr. Marcet has considered as the *experimentum crucis* in detecting the presence of arsenic. Hence I was led to perform this experiment with great care; and the result exhibited in the most unequivocal manner that the yellow precipitate, Exper. III., was not phosphate, but arsenite of silver. The crystalline sublimate is there said to be apparently granular, because their real forms, in consequence of their minuteness, could not be distinguished without the aid of a microscope; and it was my wish to preserve the tube in the state it then was. There can be no doubt, however, that the sublimate was arsenious acid.

The formation and decomposition of the yellow-coloured precipitate, and the appearances in the tube, as described in Exper. VII., may, independently of the action of sulphate of copper, be regarded as infallible, and as sufficient to establish the fact of the presence of arsenic, without further trials.

Water was employed to separate the sugar from the white powder, because, from the comparative slowness with which the metallic salts in oxides are dissolved, I presumed that the whole of the former would be liquified before the weight of the latter would be sensibly diminished. This was the fact. The solution of sugar, when examined, exhibited no trace of arsenic, nor was any sensible quantity dissolved by the water with which the powder was washed. Indeed, the proportion of arsenic which water at common temperatures is capable of dissolving is very small; for Mr. Klaproth found that 1000 parts of water at 60° Fahr. took up only $2\frac{1}{2}$ parts of arsenious acid, even although they were in contact 24 hours. †

Some persons perhaps may object to the conclusion drawn from the experiments just stated, in consequence of the smallness of the quantity operated upon. Those among them which may be considered as decisive, and which are amply sufficient to justify an unqualified opinion on the nature of the substance, viz. the formation of Scheele's green, of the yellow precipitate, Exper. III., and its decomposition, Exper. V., were made with $\frac{1}{8}$ of a grain; but their results were so obvious, that they inspired the same confidence as if they had been performed with $\frac{1}{8}$ of an ounce. That it is not necessary to operate on large quantities in order to be assured of the accuracy of the experiments; and the correctness of the inferences has been shown, among others, by Dr. Marcet, who proved that a child had been poisoned by arsenic, by examining the liquids ejected from the stomach, in which he infers that no more than $\frac{1}{8}$ of a grain could have been dissolved. ‡

Boston, May 24, 1817.

* Nicholson's Journal, vol. xxxiv. p. 174.

† Annals of Philosophy, vol. iv. p. 133.

‡ Medico-Chir. Trans. vol. vi. p. 664.

ARTICLE VIII.

Experimental Researches on the Ammoniacal Salts.

By Dr. A. Ure, of Glasgow.

(To Dr. Thomson.)

DEAR SIR,

IN a series of experiments which I executed some time ago, with the view of ascertaining the best method of separating from each other the common primitive earths, it became requisite to examine very minutely the constitution of the triple phosphate of ammonia and magnesia. On comparing my results with some of those currently received among chemists, I observed unaccountable discrepancies. These still continued to present themselves, though I repeated and varied the experiments, employing great care, and very accurate instruments of research. I was hence led to institute a somewhat general train of investigations on the saline combinations of ammonia. As these are closely connected with the profound discussions on the atomic theory with which you and your correspondents have enriched the *Annals of Philosophy*, I shall be happy to submit their results to public inspection in the same work. Aware of the intricacy of the subject, I do not offer them as a clue to guide our steps through this chemical labyrinth, but to lead back public inquiry to a department of the science which, after having been for some time a scene of keen and instructive controversy, has been lately neglected as neutral, or avoided as insidious, ground.

A quantity of water of ammonia, recently prepared from quicklime and sal-ammoniac, in a Wolfe's apparatus, was divided into three equal portions of 500 grains each. The first portion was saturated by 15·77 grains of distilled sulphuric acid, which, from multiplied experiments, I knew to contain 80·9 per cent. of dry acid, such as exists in ignited sulphate of potash. For the convenience of experimenting, the acid was so diluted that a single drop of it weighed about $\frac{1}{10}$ of a grain. The evaporation of the neutral salt was conducted in a platina capsule, such as I use in all my experiments, and was carried to dryness on a regulated sand-bath, with extreme circumspection. Towards the end, the salt was carefully stirred with a slip of platina, to prevent the sudden exfoliation of minute particles, which is apt to happen with a saline crust closely attached to the heated vessel. 21·6 grains of dry and perfectly neutral sulphate were procured. As 15·77 grains of the above oil of vitriol contain 12·77 of dry acid, 8·83 grains of the salt are base. Hence in 100 parts we have 60 sulphuric acid and 40 ammoniacal base.

2. The second portion of 500 grains took for saturation 322·7 grains of a dilute nitric acid, which, by a prior *synthesis* of nitrate of potash, were known to contain exactly 16·8 grains of dry acid.

25.79 grains of dry compact nitrate of ammonia were obtained. Of these 8.99 were base and 16.8 acid. This weight of ammoniacal base accords well with the 8.83 obtained in the preceding experiment, from the same quantity of water of ammonia. This nitrate is composed in 100 parts of 65 acid + 35 base.

3. The third 500 grains were neutralized by 303.5 grains of a dilute muriatic acid, equal to 30.35 of that whose specific gravity is 1.192, and equivalent to 8.58 grains of such dry acid, as is supposed on the old hypothesis to exist in dry muriate of potash : 17.19 grains of dry sal-ammoniac were obtained. Here we have 8.61 of base, agreeing very well with the preceding results. In 100 parts of the salt we have 50 acid + 50 base.

The mean quantity of base in the three cases is 8.75, which unites with 12.77 sulphuric acid, 16.8 nitric, and 8.58 muriatic numbers as near the saturating ratios of the acids as, with ease, volatilized and decomposed salts, we can reasonably expect. Is this base dry ammonia, or is it a hydrate of ammonia? I hope to be able presently to demonstrate that sal-ammoniac is not a chloride of ammonium, as you regard it in the fourth volume of the *Annals* but a muriate of ammonia. In this case, since the muriate in that above experiment seems to retain the whole ponderable base that enters into the other two salts, if I can prove that their base retains water, may we not infer that the muriate also retains it? Or are we to suppose that such liquid muriatic acid as contains on the old hypothesis 28.3 per cent. of dry acid, consists really of 36.5 chlorine + 1.1 hydrogen = 37.6 hydro-chloric acid. Hence the above 8.58 parts of dry muriatic acid will then correspond to 11.4 of hydro-chloric, which unite with 5.79 of dry ammoniacal base to constitute the 17.19 of sal-ammoniac obtained. Thus we have three salts of the same apparent dryness, and containing apparently the same weight of base; but the acid of the last has the faculty of dismissing the whole water, while those of the first two, susceptible in other cases of forming dry salts, here alone retain it in every temperature.

The hydro-chloric view of the combination, which we owe to the original genius of Sir H. Davy, is indeed supported by such evidence in the direct condensation of equal volumes of dry muriatic acid gas and dry ammoniacal gas into sal-ammoniac, that it is difficult to refuse our assent to its legitimacy. Yet we have precisely the same evidence for the composition of subcarbonate of ammonia. M. Gay-Lussac has demonstrated that it results from two volumes of ammoniacal gas and one volume of carbonic acid gas condensed into a solid salt. 200 cubic inches of ammoniacal gas, weighing 36.3 grains, and 100 grains of carbonic acid gas, weighing 46.34 grains, form 82.64 grains of solid subcarbonate. Hence 100 parts consist of 56 acid + 44 ammonia.

My analysis of the dense, semitransparent subcarbonate, agrees very well with this synthesis, giving 55 per cent. of carbonic acid. But from this same subcarbonate a very notable quantity of water

may be extracted in what I conceive you will think an unexceptionable manner. Dry sal-ammoniac subjected to the very same treatment yields a still larger quantity of water, corresponding to its greater proportion of ammoniacal base. But here the ambiguity relative to chlorine and muriatic acid intervenes, to unsettle our faith in the obvious deduction of water being one of its pre-existing constituents.

I shall commence with the analysis of the sulphate. Having prepared a perfectly neutral and dry sulphate, composition as above stated, 50 grains of it were intimately mixed by trituration in a mortar with 50 grains of recently ignited pulverulent lime from Carrara marble. The mixture was immediately put into a glass tube hermetically sealed at one end; and the tube having been weighed before and after, it was found that no appreciable loss was sustained in the trituration and transfer. To the open end of that glass tube, another, about 20 inches long, bent into a swan-neck at either end (which was open), but straight, and kept horizontal in the middle, was luted. This horizontal tube was surrounded with blotting-paper moistened with ether. The bottom of the sealed tube, where the dry mixture lay, was slowly heated over a charcoal furnace till it was ignited, in which state it was kept for a considerable time. Water was copiously condensed in the inside of the long tube, while ammoniacal gas exhaled invisibly from its open extremity. When I imagined the process finished, the unluted tube was weighed, and found heavier than before by nine grains. The contents were poured out, and found to be water strongly impregnated with ammonia. The sealed tube was lighter by 19·4 grains, of which 10·4 were the ammoniacal gas which was allowed to escape.

I next endeavoured to find what portion of sulphate of lime was formed, from which I could infer how much sulphate of ammonia remained undecomposed after the operation. By the cautious addition of test muriatic acid, I learned that of the 50 grains of quick-lime employed, 19·55 grains had been saturated with sulphuric acid, corresponding to 28 of dry sulphuric acid, and equivalent to 46 of the above sulphate of ammonia. Therefore four of the 50 grains were left unchanged. Of the above nine grains of liquid ammonia, I ascertained by subsequent experiments that three were gas and six water. Hence if 46 yield six of water, 100 will afford 13·04, = the quantity of water in 100 grains of dry sulphate of ammonia. And as 100 of dry sulphate contain 40, or more exactly 39, of base, this base is a hydrate consisting of 25·96 ammonia and 13·04 water, being nearly in the proportion of two parts to one. Hence the above nitrate, being constituted of the same base, will consist of 66 acid, 23½ ammonia, and 11½ water.

Dr. Wollaston's scale of chemical equivalents, which, when extended and perfected, will render the same services to chemistry that Neper's general invention of logarithms has done to astronomy and navigation, gives in the last example 65 acid, 10·9 water, and

20.7 ammonia; and in the first 61 sulphuric acid, 26½ ammonia, and 13½ water. The ammoniacal combinations seem to form the only vulnerable part of his admirable table of proportions.

My experiments were several times repeated, with a satisfactory uniformity of results.

Analysis of the Subcarbonate of Ammonia.—50 grains of dense semitransparent subcarbonate of ammonia, containing from 54 to 55 per cent. of carbonic acid, were hastily pulverized, and mixed with 50 grains of dry quick-lime. The mixture, being introduced into a tube as above described, was found to have suffered no loss of weight in the manipulations. The former arrangement of condensing tube was adopted. It was found necessary to heat the materials very cautiously, otherwise a great part of the subcarbonate escapes without decomposition. Nine grains of liquid were poured out of the refrigeratory tube, after the experiment, and much moist salt in slender needles lined its interior. The constitution of this salt I tried to determine by comparing its power of neutralizing sulphuric acid, with the carbonic acid gas expelled, and it seemed to be a semicarbonatè of ammonia, if the expression be allowable in opposition to bicarbonatè. The carbonic acid appeared to be united with double the quantity of base in the subcarbonatè. But perhaps the result proceeded from the adhering water of ammonia. It is very difficult to get rid of the complication which these needles introduce into the estimate of water. I repeated the process, using a retort and receiver, into which the moisture and saline needles condensed. These being again mixed with dry lime, and heated, afforded water tolerably free from subcarbonatè. The composition which, after many trials, I was finally led to assign to the subcarbonatè, was 54.5 carbonic acid, 30.5 ammonia, and 15 water; or 54.5 carbonic acid and 45.5 hydrate of ammonia. Now does the whole of this compound base pass into the dry sulphate, and also into the muriate, on the common hypothesis? The following experiments will show this to be the case. 21.1 grains of dense subcarbonatè were introduced into a pear-shaped vessel with a long neck, and were neutralized with dilute sulphuric acid, containing 17.5 grains of distilled acid, and 14.157 dry acid. There were obtained of dry sulphate 23.6 grains. In 21.1 subcarbonatè there are 11.5 carbonic acid and 9.6 hydrate of ammonia, to which add 14.157 acid; the sum is 23.757. Now the sulphate actually obtained was 23.6, being an exact accordance. The composition of this in 100 parts is 60.4 sulphuric acid and 39.6 base.

In numerous other experiments on the quantity of oil of vitriol requisite to neutralize a given weight of subcarbonatè of ammonia, I found that a somewhat greater proportion of acid was expended. The average may be reckoned 88 concentrated oil of vitriol to 100 subcarbonatè; and the sulphate was composed of 61 acid and 39 base. To dry the sulphate thoroughly without decomposing it, is a very nice operation.

The bicarbonatè of ammonia obtained by exposing to the air the

subcarbonate in powder till it becomes scentless, is a salt containing the same weight per cent. of carbonic acid; but its power of neutralizing sulphuric acid is to that of the subcarbonate as three to four. Hence it consists of 54.5 carbonic acid, 22.8 ammonia, and 22.75 water, being evidently equal quantities of the two latter. 100 grains saturate 66 grains of concentrated oil of vitriol. If we compare these members with those given on the scale of equivalents, we shall find a considerable difference between them. There 100 grains of subcarbonate correspond to fully 125 of oil of vitriol, and 100 of the bicarbonate to somewhat more than 80.

Having repeated my experiments on specimens of subcarbonate obtained from different quarters, I have found the results sufficiently uniform. Dense subcarbonate in its transition into bicarbonate by exposure to the air, will continually decrease in its power of neutralizing the acids; to which cause many of those anomalies, with regard to this salt, noticed in chemical works may be ascribed. Hence if more or less of the white pulverulent matter encrusting the masses of subcarbonate be taken, we shall find the deviation from Dr. Wollaston's numbers to be still greater. Aware of this source of fallacy, I was careful to avoid it, by selecting fresh compact salt which had not been exposed to the air.

Muriate of Ammonia from Subcarbonate.—50 grains of dense subcarbonate are neutralized by 87.4 grains of liquid muriatic acid, specific gravity 1.192, equivalent to 24.7 of dry acid. There were obtained of dry sal-ammoniac 47.6 grains, just beginning to rise in white vapours. 50 grains of subcarbonate contain 22.75 base, to which if we add 24.73 of dry muriatic acid, the weight, by calculating from the constituents, is 47.48; and by experiment we have 47.6, being a good accordance. Considering the base of the subcarbonate to have passed into the muriate, as the weight seems to indicate, the composition is 51 muriatic acid, 32.84 ammonia, and 16.16 water.

Muriate from Ammoniacal Gas.—3.8 cubic inches at mean temperature and pressure of ammoniacal gas are obtained from dry lime and sal-ammoniac. The gas was passed along a cooled horizontal glass tube, before being admitted into the mercurial pneumatic trough. The vessel full of the ammoniacal gas being transferred to a glass vessel containing pure water, the gas is wholly condensed, and afterwards neutralized by 44 grains of a dilute muriatic acid, equivalent to 1.24 of dry acid. 2.4 grains of sal-ammoniac were obtained. 3.8 cubic inches by Biot's table of the specific gravity of the gases, in which I believe great confidence is due, weigh 0.6916 grains, to which add 1.24 dry acid; the sum, 1.9316, falls short of the actual product by 0.4684, which in this view must be the water of its composition.

In the other mode of considering sal-ammoniac we have 0.6916 ammonia + 1.6 chlorine + 0.4 hydrogen = 2.3316 of hydrochlorate of ammonia. Here one part by weight of ammonia yields more than three times its weight of sal-ammoniac; while the base

existing in the subcarbonate yields little more than twice its weight of the same salt. 100 parts of ammoniacal gas should give by the theory of volumes 310 of sal-ammoniac; 100 of the base in the subcarbonate give 209, the deficiency being due to the water in the latter. Hence if 310 of sal-ammoniac indicate 100 of dry ammonia, 209 will indicate 67.42 present in 100 of the subcarbonate base. Hence 100 parts of subcarbonate consist of 54.5 carbonic acid, 30.67 ammonia, and 14.83 water, affording a confirmation of the preceding analysis. It probably ought to be stated in even numbers 55, 30, 15.

On Dr. Wollaston's scale, the numbers are 56 carbonic acid + 44 ammonia = 100 subcarbonate.

Analysis of Sal-ammoniac by dry Lime.—Let us now see what quantity of water can be obtained from sal-ammoniac ignited with quick-lime. The experiments executed with this view have been carried on for a considerable time past, and have been mentioned to several chemical gentlemen. Dr. Gmelin, an ingenious German chemist, the pupil and friend of the celebrated Berzelius, assisted at the repetition of some of them nearly two months ago. As it was necessary to subject the materials to a full red heat, I employed to receive them tubes of green glass, sealed at one end, and converted into Reaumur's porcelain.* A mixture of 100 grains of recently heated muriate of ammonia and 100 grains of lime was put into the tube, and over all an additional 100 grains of lime. The tube being weighed before and after, the weight corresponded to the sum of the materials. The refrigeratory horizontal tube was attached as before; but its other end had a narrow glass tube luted to it, which descended into the water of a Woolfe's apparatus. The porcelain tube was now heated, at first gently, and afterwards powerfully, for nearly half an hour, till, notwithstanding the high temperature, the water of the Woolfe's apparatus rose in the small glass tube. The whole being unluted, 19 grains of water of ammonia were condensed in the refrigeratory tube, and one grain of sal-ammoniac was found sticking to the end, which had been inserted into the porcelain tube. The porcelain tube had no ammoniacal smell; and, being weighed while hot, was lighter by 44.9 grains. The water of ammonia in the Woolfe's bottles was exactly neutralized by 115.95 grains of muriatic acid, sp. gr. 1.192, = 32.81 dry acid. After cautious evaporation, 65.05 grains of sal-ammoniac are obtained. The porcelain tube was broken into small pieces, as it was found impossible to extract the fused residuum; and the whole being put into a glass retort with water, and a little more lime, heat was applied, and the volatile matter was condensed in a Woolfe's apparatus containing water. The contents of the retort being boiled to dryness, and long after all ammoniacal smell had ceased, the water of ammonia obtained was saturated with muriatic

* This substance has been called crystallite; but the kind of glass called crystal is not convertible into Reaumur's porcelain. Crystallite may signify any crystallized stone or mineral. Vitrite seems unexceptionable.

acid, and evaporated, 5·2 grains of sal-ammoniac are procured. If to these 70·25 grains of regenerated salt we add the single grain sublimed, we have 71·25 grains. Of the strong ammoniacal water in the tube, nine grains were poured at first into the Woolfe's bottle; but 10 grains adhered to the sides of the tube, which, being washed out, yielded, after saturation, 10 grains of sal-ammoniac. The whole product of salt is, therefore, 81·25 grains, instead of 100. From these 81·25 grains, 13 of water were obtained. Hence 100 would yield 16 grains. The loss of weight in the porcelain tube consisted of the 20 grains found in the condenser, and 24·9 grains which had passed into the Woolfe's apparatus. Now the ammoniacal gas found condensed in the Woolfe's bottles, exclusive of what was in the long tube, certainly did not amount to more than 20 grains, for it did not yield 60 grains of sal-ammoniac. What are these 4·9 grains? I cannot conjecture, unless they be supposed to be water, derived from some mysterious decomposition of the six or seven parts of ammonia, corresponding to the 20 or 21 parts of sal-ammoniac, which constantly disappear in every repetition of this experiment which I have made. Of the tightness of the apparatus I am well assured. Indeed, I have performed the same experiment with a continuous glass tube, sealed and bent down at one end like a retort, while the other end was drawn into a small tube which passed under a jar on the mercurial pneumatic shelf. The middle part was kept horizontal, and artificially cooled. The sealed end contained the mixture of lime and sal-ammoniac. A brush flame of a large alcohol blow-pipe was made to play very gently on the end of the tube at first, but afterwards so powerfully as to keep it ignited for some time. The sal-ammoniac recovered did not exceed three-fourths of that originally employed.

Perplexed by this perpetual disappearance of ammonia, I imagined that perhaps a portion of nitric acid was formed at the expense of the alkali by the action on its azote of the oxygen, which by some chemists it is supposed to contain. In this case nitric acid might be found in combination with ammonia in the Woolfe's bottles, or with lime in the porcelain tube. A portion of regenerated sal-ammoniac and residuary muriate, derived from an experiment made on purpose, was separately put into two retorts. Dilute sulphuric acid was added, and, heat being applied, the volatilized acid was condensed into cooled receivers. In the acids thus procured slips of clear silver were digested for some time with a gentle heat, but not a trace of muriate of silver was to be perceived. The metallic surface was not in the least affected.

In whatever way the lost ammonia is to be accounted for, there is no incondensable product, no evolution of azote or hydrogen; for after the first discharge of the air of the apparatus, not a bubble of gas is to be seen. And since the above experiments prove that no nitric acid is formed, our only inference must be that water is the product instead of ammonia.

That the loss is not owing to the mode of manipulation which I adopt, the following experiment will prove. Into a glass retort I put a mixture of 50 grains of sal-ammoniac and 75 grains of lime, with a little water. A Woolfe's apparatus being connected, the distillation in the retort was carried to dryness. The water of ammonia in the bottles was neutralized with 94 grains of muriatic acid, sp. gr. 1.192, containing 26 grains of dry acid. After cautious evaporation, 49 grains of muriate of ammonia were recovered. The residuum in the retort being dissolved in water, filtered, freed from lime by blowing the air of the lungs through it for some time, again filtered, evaporated, and ignited, yielded of muriate of lime 52 grains, which is the quantity equivalent nearly to 50 grains of sal-ammoniac.

Though the most eminent chemists of the present day consider subcarbonate of ammonia as a compound of two gases, neither of which contains water, yet we have proved *that* subcarbonate which sublimes like sal-ammoniac without decomposition to contain about 15 parts of water in the 100. Nor is there any difficulty of assigning the origin of that water. The subcarbonate is usually produced by sublimation from a mixture of carbonate of lime and muriate of ammonia. The water either proceeds directly from the muriate, or is generated from the oxygen of the lime and the hydrogen of the hydro-chloric acid. If the subcarbonate which results from the direct condensation of the two gases yield water by being heated along with dry lime, or if it afford no more sal-ammoniac by saturation with muriatic acid than the sublimed subcarbonate does, then the whole doctrine of gaseous combination will need revision. That carbonic acid gas hygrometrically dry contains no water, is held to be demonstrated by the fact of its decomposition by potassium affording no hydrogen.

We must next turn our attention to the ammonia. This gas was submitted to the action of potassium by Messrs. Gay-Lussac and Thenard, as well as by Sir H. Davy. The results of their experiments were, however, more calculated to astonish than to instruct. We may hence judge of the intricacy of the subject; for these philosophers are not only the most brilliant discoverers, but the most luminous writers, of the age. Potassium was found to absorb 120 times its bulk of ammoniacal gas, becoming in consequence olive-green, and heavier than water. On distilling this substance in a tube of wrought platina in a very intense heat, potash was found with a quantity of potassium, and the gas was hydrogen with only a small proportion of azote.* The remarkable circumstance of this experiment is the disappearance of the principal constituent of ammonia, the azote. Now I apprehend that an analogous destruction of ammonia took place in my ignition of sal-ammoniac

* Recherches Physico-Chimiques, par MM. Gay-Lussac et Thenard; and Phil. Trans. 1809.

and quick-lime; and that the product was also analogous, namely, water. For the hydrogen in Sir H. Davy's experiment would proceed from the action of the potassium on the water, or its element oxygen, whence potash was formed. Ammonia consists, as already stated, of three volumes of hydrogen and one volume of azote condensed into two volumes, or into one half of the total volume. If we shall suppose that azote is a deutoxide of hydrogen, a volume of it might unite to a volume of hydrogen to constitute water, while a greater or smaller part might remain, according to the circumstances of the experiment, in the condition of ammonia. It may be conceived that the joint influence of the chlorine, lime, and high temperature, determine this decomposition of the ammonia, as sulphuret of potash decomposes cold water, which neither of its constituents can effect. In the dry sulphate, nitrate, carbonate (and in the old view, also the muriate), one-third of the ammoniacal base is water.

To those who wish to repeat my experiments on the decomposition, by quick-lime, of the ammoniacal salts, I may mention that at these high temperatures there are considerable difficulties to be encountered; for on the slightest relaxation of the heat, the water rushes back from the Woolfe's bottles into the apparatus, and breaks it to pieces.

In the fourth volume of the *Annals of Philosophy*, when treating of the composition of the chlorides, you have expressed your conviction that sal-ammoniac is a chloride of ammonium. It is with diffidence that I venture to controvert an opinion resting on such authority. You there state its composition to be 97·14 chlorine + 24·511 ammonium. From the preceding experiments, 100 parts of sal-ammoniac contain from 50 to 51 of dry muriatic acid, equivalent to 65 or 66 of chlorine, as inferred from the chlorides of potassium, sodium, and calcium. These 65 or 66 parts of chlorine may be united with 35 or 34 of ammoniacal base to constitute 100 of sal-ammoniac. But by your ratio of 97·14 to 24·511, 65 or 66 of chlorine should take only 16·4 or 16·6 of a base to constitute 82 of saline product, instead of 100 parts. We must add no less than 18 parts of water to 82 of chloride to make up the product of sal-ammoniac. Or, more exactly, 100 parts of ammonia unite with 209·0 hydro-chloric acid, consisting of 202·93 chlorine + 6·07 hydrogen. To constitute your chloride, these 6·07 parts of hydrogen must quit the chlorine; and, since they do not escape as hydrogen, must find 46·0 parts of oxygen, their saturating quantity, whence 52·07 parts of water will result. Of ammoniacal base there remain 54·0 parts, of which 18·47 are its original hydrogen, as deduced from Gay-Lussac's theory of volumes; but by your weights of the atoms (*Annals of Philosophy*, vol. iii.) 100 ammonia contain only 6·82 parts of hydrogen and 93·18 azote. Assuming Gay-Lussac's numbers from their correspondence with the analysis of ammonia by Berthollet and Davy, the 54 parts of basis unite with 202·93 chlorine to form 256·93 sal-ammoniac or

chloride of ammonium; and 100 parts will consist of 79 chlorine + 21 ammonium, containing 7.2 hydrogen and 13.8 azotium. But by your view of ammonia, the composition of these 21 parts of ammonium is 2.65 hydrogen + 18.35 azotium, using this term to denote the azotic base which remains when the oxygen has been withdrawn by the hydrogen of the muriatic acid gas. If we take the water into the account of the composition of the salt, then the numbers will stand correctly,

Chlorine	65.67
Ammonium	17.48
Water	16.85
	<hr/>
	100.00

We know how speedily the amalgam of ammonium is decomposed by a drop of water, and we also know that five parts of chlorine can resolve one part of ammonia into its ultimate constituents, though ammonia in this view, being an oxide, should be less readily acted on than its metallic radicle. How then can we conceive the existence of ammonium in the midst of chlorine and water, all together forming one of the least destructible of compounds? Besides, the presence of water is, I believe, considered to be incompatible with the existence of metallic chlorides. It converts them into hydro-chlorates of the metallic oxides. Sal-ammoniac, regarded as such, is no less an anomaly, being, I imagine, the only dry hydro-chlorate, and is composed in 100 parts of 66 chlorine, 2 hydrogen, and 32 ammonia. These 2 of hydrogen will take 15 oxygen from the lime to form the water obtained in my experiments. If it be called a dry chloride of ammonium, then to account for the 16 or 17 parts of water so procured, we must expend $\frac{2}{3}$ of the 2.65 parts of hydrogen, which on your statement 21 parts of ammonium contain, and consequently only $\frac{1}{3}$ of the ammonia should be recoverable, instead of from $\frac{2}{3}$ to $\frac{1}{3}$.

According to MM. Gay-Lussac and Thenard, when three parts of ammoniacal gas and one of chlorine are mixed together, they condense into sal-ammoniac, and azote equal to $\frac{1}{10}$ the whole volume is given out. This statement merits examination. Taking the composition of ammonia given by the same distinguished chemists, this alkaline gas contains in a condensed state half its volume of azote and $1\frac{1}{2}$ its volume of hydrogen. Hence 15 volumes, when they condense with five of chlorine, and leave $\frac{1}{10}$ of the whole volume, or two of azote, retain of the $7\frac{1}{2}$ azote present in 15 of ammonia, $5\frac{1}{2}$. These $5\frac{1}{2}$ require $16\frac{1}{2}$ of hydrogen, together equal to 22 in volume, but condensed into 11 of the ammonia. But 15 of ammonia contain $22\frac{1}{2}$ of hydrogen, $16\frac{1}{2}$ of which are now condensed, leaving 6 to convert the chlorine into hydro-chloric acid. There are, however, only five of chlorine altogether, which take five of hydrogen to form 10 volumes of hydro-chloric acid. Hence one volume of hydrogen is unoccupied; and as 10 grains of hydro-chloric acid take 10 grains of ammonia to constitute sal-ammoniac,

a volume of the alkaline gas will be also insulated. Thus there will remain unprovided for, or in a gaseous state, one volume of hydrogen, one volume of ammonia, and two of azote, being $\frac{1}{3}$ of the original bulk, instead of $\frac{1}{6}$ of azote alone. As 15 of ammonia are here reduced to 11, 100 would become $73\frac{1}{3}$, $26\frac{2}{3}$ of ammonia being destroyed in this combination. And if 15 volumes of ammonia be mixed with $18\frac{2}{3}$ of chlorine, or 100 with 125, the decomposition of the alkali will be total. The phenomenon of combustion is to be ascribed to the condensed state of the hydrogen.

I shall conclude with describing an easy method of separating carbonic acid gas and chlorine from muriatic acid gas. When the two former are subjected to dry quick-lime at ordinary temperatures, there is no condensation. I exposed carbonic acid gas, previously dried by muriate of lime, to dry lime over mercury, for 20 hours, using occasional agitation; but the bulk of gas continued the same. This phenomenon surprized me; for since water is foreign to the constitution of carbonate of lime, nay since it aids the expulsion of the gas from the ignited carbonate of lime and barytes, or weakens its affinity for the calcareous base, I could not expect that water would, on the contrary, render their affinity efficacious, or be essential to their re-union. On admitting a little of the pulverulent hydrate to the gas which had resisted the action of dry lime, absorption speedily took place. Chlorine unites very readily also with the calcareous hydrate. Muriatic acid gas, on the other hand, I found speedily to condense by exposure to dry lime. Hence in the controversial experiments of Dr. Murray and Dr. John Davy, where chlorine, carbonic oxide, and hydrogen, were mixed, the muriatic acid generated will be detected and withdrawn by dry lime, and metallic laminæ will condense the chlorine; when the carbonic acid, if it be a product, will remain to be examined in the usual way.

These phenomena at the first aspect might lead one to believe that, since dry gases will not unite with dry lime, there must be water in muriatic acid gas to favour its combination. We may, however, regard it as a case of complex affinity, in which chlorine and calcium, hydrogen and oxygen, by the sum of their respective attractions, determine the combination.

Several important branches of the above inquiry, particularly that relative to the results of mixing chlorine and ammonia in various proportions, I have been unfortunately prevented from entering upon, in consequence of the only apartment of the Institution where such experiments can be safely made having been alienated to other uses for some time.

I am, dear Sir, your most obedient servant,

ANDREW URE,

ARTICLE IX.

Report made to the Academy of Sciences, Oct. 14, 1816, on a second Memoir of M. Hachette, relative to the running of Fluids through Orifices with thin Sides, through cylindrical or conical Pipes, and through capillary Tubes.

THE Academy has charged MM. Poisson, Ampere, and myself (M. Cauchy), to give an account of the new memoir of M. Hachette on the flowing of liquids through orifices with thin sides, and through pipes applied to these orifices. It will be recollected that M. Hachette has already presented a set of experiments on this subject, which, in consequence of the report * of M. Poisson, has gained the approbation of the Academy. Some of the new experiments confirm the conclusions established in the first memoir; others offer new results. We shall give an account of both sets, and show how the author has ascertained the influence on the flow of water produced by the size of the orifice, its shape, that of the surface in which it is placed, the addition of a cylindrical or conical pipe, the height of the liquid, the kind of liquid, and the nature of the surrounding medium.

Size of the Orifice.

All other things being equal, the contraction † of the vein which issues from an orifice with thin sides diminishes with the dimensions of the orifice. This proposition, which M. Hachette had established in his first paper, is confirmed in the present by new experiments. These experiments, however, induce him to augment the contraction of the vein, which he had at first given for a circular orifice of a millimetre in diameter, and to raise it from 0.22 to 0.31. The contraction is reduced to 0.23 when the orifice has a diameter of $\frac{3}{10}$ of a millimetre. In the apparatus employed to measure running water by inches of the engineer, it is 0.31, as in the first

* See *Annals of Philosophy* for July, 1817, vol. ix. p. 31.

† We call *contracted section* the smallest section made in a vein parallel to the plane of the orifice; and *contraction of the vein*, the difference between the area of the orifice and the area of the contracted section, when the area of the orifice is taken for unity. As the common velocity of all the points of the contracted section is nearly the velocity due to the height of the fluid above the orifice, it follows that the real waste does not differ sensibly from what would be furnished by the theorem of Torricelli for an orifice equal in surface to the contracted section. Hence if we compare the theoretic expense calculated for the given orifice with the real expense, the difference between the two referred to the theoretic expense taken for unity will be the measure of the *contraction of the vein*. It is likewise, in some measure, the contraction of the expense. On this account we shall hereafter distinguish by the name of *contraction* the excess of the theoretic expense above the observed expense, referred to the first of these expenses, even in the case when the velocity of the contracted section is no longer that determined by the theory of Torricelli.—(Note of the Reporters.)

of the two preceding cases. For diameters above 10 millimetres, the contraction becomes almost constant, and is included between the heights 0.40 and 0.37.

In considering what is the size of orifices employed to obtain a contraction of from 0.31 to 0.23, we have inquired whether thicknesses of the sides of the vessel which might be neglected relatively to orifices of 10 millimetres in diameter ought still to be considered as thin with respect to orifices whose diameter is one millimetre, or below it. We conceive that we cannot leave that thickness out of consideration whenever it is such as to be comparable to the diameter of the orifice. In that case, under certain pressures at least, it ought to act on the fluid vein like a cylindrical pipe; that is to say, increase the expense, as we shall see afterwards. Perhaps we ought to ascribe in part to this cause the diminution of the contraction observed in the flow from orifices of a very small diameter, and probably it would be possible, without varying the diameter, to obtain different contractions by varying the thickness. This conjecture will explain why orifices of a millimetre in diameter have not always given the same product. But new experiments are requisite to determine the point with certainty.

Form of the Orifice.

The form of the orifice, when the sides are thin, has no sensible influence on the expenditure, unless it contains re-entering angles; but it has a marked influence upon the exterior surface of the fluid vein. As the contraction increases with the dimensions of the orifice, it was natural to think that when a fluid vein escapes between the two sides of a saliant angle, the contraction ought to increase in proportion to the distance from the summit of the angle; so that a section made at a little distance from the plane of the orifice, and parallel to that plane, shall be terminated, not by two straight lines, but by two curve arches convex to each other. This is what actually happens. Hence when the contour of the orifice is a regular polygon, each side of the polygon becomes the base, not of a plane, but of a surface, which, viewed externally, is convex from the orifice to the contracted section. The concavity of the surface, after having reached its maximum between these two sections, diminishes as we approach the contracted section, and even changes beyond it, in consequence of the velocity acquired, into a very evident convexity, so as to show a saliant edge when there was a hollow before. This hollow, and the saliant edge that succeeds it, are produced on the middle of the side which we examine, and are situated in a perpendicular plane on the same side. When the contour of the orifice presents a re-entering angle, an edge hollow at first, and convex afterwards, passes by the summit of this angle.

Form of the Surface on which the Orifice is placed.

According as this surface turns its concavity or convexity towards the interior of the vessel which contains the liquid, the expenditure

increases or diminishes. M. Hachette confirms this assertion by the example of an orifice whose contour presents a re-entering angle, and which is situated at the extremity of a pyramid concave towards the interior of the vessel. By simply turning the pyramid, the expenditure is varied from 100 to 71. This effect ought to be ascribed, like the phenomena of capillary tubes, to the adhesion of the liquid to the sides of the vessel, and of the liquid to itself. It is the same cause which produces the phenomena of pipes, as we are going to explain.

Addition of a cylindrical Pipe.

When a cylindrical or conical pipe is added to an orifice, it may happen that the fluid vein adheres to the inside of the pipe, and fills up its whole capacity, or it may detach itself from the sides. In the last case the flow takes place exactly as if no pipe were added. But on the other hypothesis, the action exercised on the interior molecules of the vein by those which are in contact with the inside of the pipe, produces the double effect of dilating the vein or of diminishing its velocity.

When the length of the pipe is not sufficient to render the last of these two effects sensible, the dilatation of the vein produces a considerable increase in the expenditure. Thus when a circular orifice of $9\frac{1}{4}$ millimetres in diameter has given, under a pressure of 142 millimetres, a contraction of 0.37, it is sufficient to add to this orifice a pipe of equal diameter, and of six millimetres of length, to obtain under a pressure of 30 millimetres a contraction of 0.07 only.

When the length of the pipe becomes very considerable relatively to its diameter, the velocity of the fluid molecules is sensibly retarded by the action of those which are in contact with the inside of the pipe. The consequence is a diminution of the expenditure, which destroys a part, and sometimes even surpasses the whole augmentation, produced by the dilatation of the vein. For example, if in the last example we increase considerably the length of the pipe, the expenditure will become much less: the contraction, according to the calculation of Poleni, will increase from 0.07 to 0.18.

If we fit a pipe to a given orifice, so that a portion of the pipe penetrate through the orifice into the inside of the vessel in which the liquid is confined; if, besides, the pipe be very thin towards the extremity at which the liquid is introduced, the effect will be the same as when the orifice is made in a surface convex towards the inside of the vessel; that is to say, the expenditure will be diminished. Borda has observed that when large pipes with thin sides, and entirely plunged into the liquid, are employed, the expenditure is reduced to one-half.* When we employ a capillary tube

* I proposed to diminish this expenditure by placing in the inside of a cylindrical pipe another parallel pipe of a smaller diameter. The lower bases of these

with a thin end, the cause just announced, joined to the diminution of the velocity, from the length of the tube being always very great when compared with its diameter, ought to produce a considerable diminution in the expenditure. M. Hachette verified this conjecture by means of a capillary tube whose length was 49.3 millimetres, and its diameter 1.19 millimetre. This tube terminated in a cone towards its extremity, occasioned under a pressure of 24 centimetres a diminution of 0.60 in the expenditure, calculated according to the theorem of Torricelli.

When we increase indefinitely the length of a capillary tube, we at last reach a limit beyond which the liquid flows out only drop by drop; but this limit varies with the height of the liquid above the orifice, as we shall see immediately.

Height of the Liquid above the Orifice.

The contraction of the vein diminishes with the height, or which is the same thing, with the pressure resulting from it. Thus, for example, while an orifice of 27 millimetres of diameter gives, under a pressure of 15 centimetres, a contraction of about 0.40; the same orifice, under a pressure of 16 millimetres, gives only a contraction of 0.31.

Since the fluid vein has a tendency to contract in proportion as the pressure increases, it was natural to think that when a pipe is employed, the fluid, by pressures always increasing, ought to tend more and more to detach itself from the inside of the pipe, and at last to separate itself altogether. This accordingly actually happens. The pressure necessary to produce the separation diminishes, as was to be expected, as the length of the pipe increases. It is less for a conical pipe than for a cylindrical one, and decreases at the same time as the angle at the summit of the cone, which is under consideration. M. Hachette found that for a pipe of six millimetres in length and $9\frac{1}{2}$ in diameter, it was still superior to 30 millimetres. He destroys, therefore, an opinion supported by Mr. Vince,* an English philosopher, that the flow cannot take place with the tube full in pipes shorter than six millimetres.

When the height of the liquid above the orifice becomes very small, the fluid vein at last acquires a particular form, very different from that which it had before, and which seems independent of the form of the orifice. M. Hachette calls this kind of veins *secondary veins*. He has observed them alike with orifices and pipes of all figures and sizes.

If we make the height of the liquid decrease indefinitely after having obtained secondary veins, we at last reach a limit beyond which the flow ceases to be uninterrupted. M. Hachette has par-

two tubes were in the same plane, and the first rose above the second. Instead of diminishing the expenditure from 1 to $\frac{1}{2}$, as Borda had done, I diminished it only in the ratio of 1 to 0.92.

* See his memoir, *Phil. Trans.* lxxxv. for 1795.

ticularly examined the laws of this last phenomenon in the case when cylindrical capillary tubes are employed as pipes. Six experiments* made upon similar tubes of different lengths, and of the same diameter, appear to prove that the limit in question is proportional to the length of the tubes.

When the vessel containing the water has a very small size relative to the orifice, the form of the vein is sensibly altered, and becomes very irregular; but we can always make this irregularity disappear by increasing sufficiently the height of the liquid. †

Nature of the Fluid.

The experiments above related were made with water. Most of the phenomena remain the same when mercury is substituted for water. Thus, for example, the contraction relative to an orifice of one millimetre in diameter with thin sides, and that which under a pressure of 24 centimetres, a capillary tube of 49·3 millimetres in length, and 1·19 millimetre in diameter, gives, will be for mercury as for water, the first 0·31, and the second 0·60.

Alcohol, whose molecules adhere less to each other than those of water, flows out more readily. For the same reason, the pressure necessary to detach a fluid vein from the inside of a pipe is smaller for alcohol than for water. ‡

When oil is substituted for water, the viscosity of the oil increases considerably the duration of the flow of the fluid through small ori-

* These experiments were made upon a glass capillary tube, 0·53 millimetre in diameter. Having put it in a vertical position, water was made to flow from it by means of pressures measured exactly by means of the apparatus described in p. 219 of this report.

The length of the tube was at first 980 millimetres; and having successively diminished this length, five other tubes were obtained of the same diameter, and of the following lengths:—

780, 580, 380, 180, 90, millimetres.

The constant flow ceased in each under the following pressures:—

586, 464, 342, 233, 120, 52 millimetres.

The pressures, calculated on the hypothesis that they are *proportional to the lengths of the tube*, would be

466, 346, 227, 107, 53, millimetres.

The small differences between the results of calculation and observation may be owing to a slight curvature in the tube, to the inequality of its interior sections, or to the uncertainty under which all these observations labour.

This experiment may be repeated with capillary tubes of different diameters, taking care that for water, for example, the diameters are below a millimetre; otherwise the thread would be constant, how small soever the height of the liquid above the inferior orifice of the tube.—H. C.

† I avoided by the same means the helical motions in the capillary tubes which I used to study the motions of liquids in these tubes.—H. C.

‡ This result agrees with the following experiment of M. Gay-Lussac, which M. de Laplace has related in his *Mecanique Celeste*, supplement to book I. p. 54.

^ A disc of glass of the diameter 118·366 millimetres was moistened successively with water and alcohol, and placed in contact with the surface of these liquids: the weights of the liquid column raised at the instant that it detaches itself from the disc are equal to 59·4 grammes and 31·147 grammes.—H. C.

lices. Through an orifice of one millimetre in diameter, the time of the flow of these two liquids was in the ratio of one to three.

The nature of the fluid is one of the principal causes on which depend the continuity or discontinuity of the jet in the flow through capillary tubes. When water was employed, the thread remained continuous at all pressures for a tube with a diameter equal to or greater than a millimetre. But when oil was used, the flow through a similar tube, whose length did not exceed five centimetres, was only drop by drop under a pressure of a column of oil more than a metre in height.

Surrounding Medium.

In experiments on the flow of a fluid by a given orifice or pipe, the surrounding air may influence in two ways: 1. By modifying the pressures on the orifice by the liquid under consideration. 2. By opposing a certain resistance to the emission of the liquid, or to its motion. That the first of these two effects may become sensible, it is necessary that the vertical pressure exercised from the top to the bottom on the upper surface of the liquid, and the pressure in a contrary direction on the exterior surface of the orifice or pipe should be very different from each other. This happens when we leave the upper part of the vessel containing the liquid exposed to the open air, and place the orifice or the pipe through which the liquid flows under the receiver of an air-pump, in which the air may be rarefied at pleasure. By means of this artifice, and by diminishing progressively the elastic force of the air under the receiver, we observe the same phenomena which are produced in the open air by the gradual augmentation of the height of the liquid. We have even the advantage of being able to determine a very considerable pressure at little expense. It was by this method that M. Hachette was able to determine the diminution of the expenditure under a pressure equivalent to 10 metres of water, for capillary pipes terminated in cones towards the orifices—a diminution which was found the same as for pipes with thin sides and of a large diameter entirely plunged into a liquid.

If, instead of increasing the pressure, we wish to diminish it, it obviously would be sufficient to leave the given orifice or pipe exposed to the free air, and to put the upper surface of the liquid in contact with air rarefied under the receiver of an air-pump.

It remains for us to speak of the resistance opposed to the issue and to the motion of the fluid vein by the surrounding medium. Some philosophers have thought that we ought to ascribe to that resistance the changes of form which the vein experiences under variable pressures; but this conjecture is destroyed by the experiments of M. Hachette. He observed no difference in the form of the fluid veins produced by the flow of water and mercury through a triangular orifice in the air and in a vacuum.

The flow of a liquid through small cylindrical tubes seems entirely

to depend upon the resistance and density of the surrounding medium. Mr. Matthew Young* had already remarked that in this case, if we place the apparatus under the receiver of an air-pump, the flow continually decreases with the density of the air, and that in the open air the vein runs in a full stream filling the pipe, while in a vacuum it detaches itself from the sides of the pipe. But that philosopher does not appear to have suspected the difference which exists in this respect between tubes of a great and of a small diameter. M. Hachette has ascertained that a tube of 6.6 millimetres in diameter only gave two different products for all densities of the air, according as the fluid vein filled or did not fill the pipe. But when he employed a tube whose diameter was reduced to three millimetres, he obtained, like the British philosopher, an expenditure varying with the density of the air. Mr. Young concluded from his experiments that this expenditure reaches its maximum when the elastic force of the air is equivalent † to the weight of the liquid contained in the pipe, and that in this case the liquid fills the pipe; but this conclusion appears very doubtful. All that we can be sure of is, that for tubes of a very small diameter, when we diminish the elastic force of the air beyond a certain limit, the expenditure continually decreases. M. Hachette supposes with much probability that in that case the vein fills only a part of the pipe, and he ascribes this effect to the compression coming from the air, which endeavours to enter into the pipe to replace that which the motion of the liquid has necessarily carried off. When the diameter of the tube augments, a double current of air may be established, and the effect of which we are speaking ceases to take place.

It is evident from what has been said that M. Hachette has determined with much care the principal circumstances of the phenomena which the motion of fluids presents, and sometimes even the laws of these phenomena. Still some questions relative to this subject remain to be resolved; as, for example, what ought to be the thickness of the walls of an orifice in order that it may exercise a marked influence on the expenditure? According to what law, when this influence is abstracted, does the contraction vary with the height of the liquid and the diameter of the orifice? Supposing the diameter given, what is the pressure at which the fluid vein changes into a secondary vein, and that at which the flow ceases to be constant? How does the pressure capable of separating a fluid vein from the sides of a cylindrical tube vary with the diameter, the length of the pipe, and the elastic force of the surrounding air? Finally, what length must we give to a cylindrical pipe of a deter-

* See his papers, *Memoirs of the Irish Academy*, vol. vii.

† I demonstrated in the first memoir on the flow of liquids through pipes, that when we increase the velocity of the liquid which issues from a pipe which it fills, the liquid vein detaches itself from the inside of the pipe, even when the elastic force of the medium in which the flow takes place is very superior to the weight of the liquid contained in the pipe.—(Note of M. Hachette.)

the diameter to obtain the maximum of expense? These are any problems which we will propose with confidence to M. Lavoisier. We think that, in engaging him to continue this kind of researches, the Academy ought to approve of his memoir, and that it to be printed in the *Recueil des Savans Etrangers*. *

ARTICLE X.

Proceedings of Philosophical Societies.

ROYAL ACADEMY OF SCIENCES.

Analysis of the Labours of the Royal Academy of Sciences of the Institute of France during the Year 1816.

HISTORICAL PART.—By M. le Chevalier Cuvier, Perpetual Secretary.

(Continued from p. 146.)

BOTANY AND VEGETABLE PHYSICS.

One of the most important botanical considerations, and which affects it more than any other branch of natural history with the physical sciences in general, is vegetable geography, or the science which treats of the laws of the distribution of plants according to the height of the soil, the elevation of the soil, the temperature, and the dryness or moisture of the climate.

Alexander von Humboldt, whose travels have advanced so remarkably this branch of knowledge, as well as several others, has just published a kind of complete treatise of it, under the title of *Prolegomena de Distributione Geographica Plantarum secundum Coeli Latitudinem et Altitudine Montium*,† a work in which he gives at the same time profound researches on the distribution of heat, whether relative to the position of places, or to the seasons of the year. Not only the lines under which the mean annual temperature is the same are far from being parallel to the equator; but the places which have their whole mean heat equal are far from having their summers and winters similar. This mean heat may be more or less equally spread through the whole of the year, and it is obvious

In a third memoir I shall examine the motion of viscid liquids, I shall compare with each other the liquids of this kind which we obtain by dissolving in water gum, sugar, soap, glue, mucilage, &c. Bringing all these liquids to the same density, I shall measure the velocity of their flow, the difference of which will depend in that hypothesis on the adhesion of the particles of liquid to each other and to the sides of the vessel.

Petit and myself have ascertained, by an observation on the refraction, that when a liquid flows in a glass prism, taking care that the sides of the prism are not altered by the motion, the density of the liquid is the same, whether it is at rest or in motion.—H. C.

Paris, 1817, one volume, 8vo.

that all these differences ought to have considerable influence on the propagation of plants. The author then passes to the differences which result from the elevations, which differ considerably, and follow different laws in different places. Finally, M. de Humboldt comes to a consideration quite new, on which he has likewise published a dissertation in French; namely, that of the distribution of vegetable forms. On comparing in each country the number of plants of certain well-determined families with the whole number of vegetables, we discover numerical ratios of a striking regularity. Certain forms become more common as we advance towards the pole; while others, on the contrary, augment towards the equator. Others acquire their maximum in the temperate zones, and diminish equally by too much heat and cold: and, what is remarkable in this distribution remains the same round the whole globe, following not the geographical parallels, but those which M. de Humboldt calls *isothermic*; that is, lines of the same mean temperature. These laws are so constant, that, if we know in a country the number of species of one of the families, of which M. de H. has given a table, we may nearly conclude from it the total number of plants, and that of the species of each of the other families.

The prolegomena of which we have just spoken are placed at the head of the great work which M. de H. is at present publishing with MM. Bonpland and Kunth, on the new plants which he discovered in South America. This augmentation, the richest perhaps and most brilliant which botany has received at any one time, will be explained in six quarto volumes, which will contain 600 plates and descriptions of more than 4000 species. MM. de Humboldt and Bonpland have published at the same time the conclusion of their description of the Melastomes, a work externally more magnificent, but which could not be followed for the remaining plants without inducing an expense and a delay prejudicial both to the science and to those who cultivate it.

In collecting thus without interruption the immense products of the great and laborious enterprise of this illustrious traveller, the friends of the sciences are in doubt whether they owe more gratitude to the courage which supported him amidst so many reverses and fatigues, or the perseverance which he has shown in communicating the result of his acquirements.

Even at present M. de Humboldt is publishing in London, along with Mr. Horner, a quarto volume, which will exhibit 300 species of mosses, lichens, and other cryptogamous plants. He has presented one of the plates to the Academy.

M. de Beauvois, whose perseverance is equally deserving of praise in publishing the plants and insects collected in his travels, has given this year the 14th and 15th parts of his *Flora of Owar and Benin*; and not satisfied with these ancient collections, he has taken advantage of the remarkable and disagreeable wetness of this year to prosecute the study of the fungous family of plants. The constant rains brought so many of them forward, that several pre-

ented themselves which had escaped preceding botanists, even the most successful in that kind of study. For example, a variety of sclerotium, which reduced the crop of kidney beans without branches to nearly a third of the usual quantity; a new species of spheria, which injured the onions very much; a new species of uredo, which was still more pernicious to them; and, what is remarkable, and offers few examples in the vegetable kingdom, a new species of parasitical plant, which grows upon another parasitical plant, and injures the vegetable considerably, which is obliged to nourish them both. It is a species of tubercle, which fixes itself above the root of the orobanche racemosa, which is known to grow parasitically upon hemp. This tubercle possesses characters which makes it approach to truffles and to sclerotium; but with distinctions, which constitute it a new and intermediate genus. As M. de Beauvois proposes next year to repeat his observations on this very remarkable plant, he has deferred assigning it a name till he has more accurately determined its manner of growing, and all the details of its organization.

It is known that the family of dipsacæ, such as the scabiosa, are very near the composite plants in several characters of their flower and their fruit. The most obvious mark of distinction is, that their antheræ are entirely free. Botanists have discovered some plants with flowers formed equally of several smaller flowers, whose antheræ are united by their lower part only. It was doubtful in what place to arrange them. M. Henry de Cassini, who examined them as a sequel to his great work on the family of synantheræ, or composite plants, of which we have had occasion to speak several times, has found that they differ from the synantheræ, because their antheræ have no appendices at the summit, because their style and stigma have a different formation; because the seed is suspended at the summit of the cavity of the ovarium, and contains a thick and fleshy albumen. They differ from the dipsacæ by having their antheræ united below, and by their alternate leaves; but the most part of their other characters are common with these two families. In consequence M. de Cassini thinks that a distinct family may be made of them, which will serve to connect the two others, and which he distinguishes by the name of *boopideæ*. It will comprehend the genus *calycera* of Cavanilles, *boopis* and *lacicarpa* of M. de Jussieu.

We announced last year the opinion of M. de Candolle respecting that injurious substance called ergot (the *spur*), and which shows itself upon the spike of rye, and of some other corns, especially in moist countries and seasons. The year 1816, unfortunately, produced a great deal of it; and M. Virey has made some researches on it, which lead him to consider the *ergot*, according to the old opinion, as a degeneracy in the grain, and not as a fungus of the genus *sclerotium*, as is the opinion of M. de Candolle. He says that he has observed grains infected with the *spur*, which not only preserved their *natural form*, but which still continued to display

the remains of stigmata; and he mentions the assertion of M. Tessier, that we often observe grains one half of which only is infected, and sometimes the half towards the summit, sometimes towards the base.

M. Vauquelin has made a comparative analysis of healthy rye, infected rye, and of a sclerotium well defined as such.

In the infected grain we find neither starch nor gluten in their natural state, though it contains a mucous matter, and abundance of a vegeto-animal matter disposed to putrefaction. It contains a fixed oil quite formed. The principles of sclerotium are very different. These experiments, without being decisive, have induced some persons, as well as M. Virey, to hesitate whether the *ergot* be a fungus.

M. Gail, Member of the Academy of Belles Lettres, has communicated to us some critical inquiries relative to the plants mentioned by Theocritus. The object of them is not so much to determine the species as to explain why Theocritus came to give them certain epithets, or to make certain comparisons respecting them. They are of course as much philological as botanical; and the public will know them more in detail by the analysis of the Academy to which that celebrated Greek scholar belongs.

ZOOLOGY, ANATOMY, AND ANIMAL PHYSIOLOGY.

Animals have likewise their geography; for nature confines each species within certain limits, by ties more or less analogous to those which confine vegetables. Zimmerman formerly published a work on the distribution of animals, which was not destitute of celebrity. Latreille has just published one on the distribution of insects. It is obvious that it must be intimately connected with that of plants; and in reality we find upon the mountains of a warm country the insects that inhabit the plains of colder countries. The difference of 10 or 12 degrees of latitude occasions always at an equal height particular insects; and when the difference amounts to 20 or 24 degrees, almost all the insects are different. We observe analogous changes corresponding to the longitude, but at distances much more considerable.

The old and new world have different genera of insects which are peculiar to each. Even those which are common to both present appreciable differences. The insects of the countries surrounding the basin of the Mediterranean, and those of the Black Sea and of the Caspian; those likewise of a great part of Africa have much analogy with each other. These countries constitute the especial domain of the coleoptera, which have five articulations in the four anterior tarsi, and one less in the two that are situated behind. America presents, besides the insects that are peculiar to her, a great number of herbivorous insects, such as *chrysomeles*, *charansons*, *cassides*, *capricornes*, *butterflies*, &c. Those of Asia beyond the Indus have a great affinity both in the families and genera of which they constitute a part. The species of New Holland, though

near the Moluccas, differ notwithstanding in essential characters. The islands of the South Sea and of South America appear to show in this respect some general relations, while the entomology of Africa exhibits an essential contrast in several points with that of South America.

In the western parts of Europe the domain of southern insects appears very distinctly as soon as in going from north to south we come to a country favourable to the cultivation of the olive. The presence of the *bousier sacré* and of scorpions announces this remarkable change of temperature. But it does not take place in North America till we approach four or five degrees nearer the equator. The form of the new continent, the nature of its soil and climate, produce this effect.

M. Latreille then explains a new division of the earth by climates. Greenland, though very near America, appears from the fauna given by Otho Fabricius, to approach more in this respect to northern and western Europe. We may at least consider Greenland as a country intermediate between the two worlds. On this account M. Latreille takes it as a position for his first meridian, which, passing 34° west from that of Paris, proceeds into the Atlantic Ocean, and terminates at Sandwich Island, in the 60th degree of south latitude, the *ne plus ultra* of our discoveries towards the antarctic pole. This meridian, setting out at 84° of north latitude, the last approximative term of vegetation, and proceeding to 60° of south latitude, is cut at every 12 degrees, by circles parallel to the equator. The intervals form as many climates, which M. Latreille distinguishes by the names of *polar, subpolar, superior, intermediate, supertropical, tropical, and equatorial*. But as the insects of America differ specifically from those of the ancient continent, and as the insects of Eastern Asia (beginning at the basin of the Indus) appear distinct in several general relations from those of the western parts, M. Latreille in the first place divides the two hemispheres by another meridian, which he places at 182° east from that of Paris, and then divides each continent into two great portions by means of two other meridians; the one is 62° further west than Paris, and passes on the western limits of the basin of the Indus; the other cuts America 106° west from Paris, and cuts off that part of the continent which lies nearest Asia, and perhaps approaches it most in the nature of its productions. The two hemispheres are thus divided longitudinally into two zones, the one oriental, the other occidental.

All Paris had it in its power to see a woman brought from the Cape of Good Hope distinguished by the name of the Hottentot Venus. She belongs to a nation in the interior of Africa celebrated among the colonists at the Cape for its ferocity, and which the barrenness of the country that they inhabit, and the persecutions of the people in their neighbourhood, contribute equally to render miserable. The smallness of their size, the peculiar shape of their

heads, the yellowness of their skin, and particularly the enormous size of the hips in the women, seem to render them a very distinct race from the negroes and caffrees by whom they are surrounded. A great deal has been said about the apron of these women, which the first travellers described very inaccurately, while recent voyagers have gone so far as to deny its existence altogether.

The woman of whom we have spoken having died in Paris, M. Cuvier had an opportunity of dissecting her, and of determining the peculiarities of her structure. She possessed the apron; but it was neither a fold of the skin of the belly, nor a peculiar organ. It was only a considerable prolongation of the upper part of the nymphæ, which fell over the opening of the vulva, and covered it entirely. The protuberance of the hips is composed of a cellular matter, filled with fat, nearly similar to the bunch on the back of camels and dromedaries. The skeleton preserves no traces of it, unless it be a somewhat greater size of the edges of the pelvis. The head exhibited a singular mixture of the characters of the negro and of those of the Calmuc. Finally, the bones of the arm, remarkable for their smallness, exhibit some distant relations with those of certain apes.

One of the most formidable serpents after the rattlesnake is the yellow viper, or *fer-de-lance*, of Martinique and St. Lucia, on which M. Moreau de Jonnés has read to the Academy an interesting memoir. Naturalists at present place it among the trigonocephali, characterized by the pit situated behind the nostrils. It fills the principal of the colonies that remain to us. Some affirm that it was formerly brought there out of hatred to the Carabees by the Arrouages, a little people on the borders of the Oronoko—a tradition which might explain why it has remained unknown in the other Antilles. From the sea shore to the top of the Mornes we are exposed to its attacks; but its principal refuge is among the sugar-canes, where multitudes of rats serve it for food, and where it is propagated with a rapidity proportional to the number of its young, which amounts to 50 or 60 at a time. Its length is sometimes more than six feet. Vain attempts have been hitherto made to destroy these vipers by pursuing them with English terriers. M. Jonnés proposes to try against them that bird of prey with long legs called *messenger* or *secrétaire* (*falco serpentarius*, L.), which devours so many serpents in the neighbourhood of the Cape of Good Hope; and the administration has already thought of transporting this useful species to Martinique. Probably the *mangouste* would not render less important services.

(To be continued.)

ARTICLE XI.

SCIENTIFIC INTELLIGENCE; AND NOTICES OF SUBJECTS
CONNECTED WITH SCIENCE.

I. Lectures.

Medical School, St. Bartholomew's Hospital.—The following Courses of Lectures will be delivered at this hospital during the ensuing winter, to commence Oct. 1 :—On the Theory and Practice of Medicine ; by Dr. Hue.—On Anatomy and Physiology ; by Mr. Abernethy.—On the Theory and Practice of Surgery ; by Mr. Abernethy.—On Chemistry and Materia Medica ; by Dr. Hue.—On Midwifery ; by Dr. Gooch.—Practical Anatomy, with Demonstrations ; by Mr. Stanley.

St. Thomas's and Guy's Hospitals.—The usual Courses of Lectures given at these Hospitals will commence the beginning of October, viz. :—

At St. Thomas's.—Anatomy, and Operations of Surgery ; by Mr. Astley Cooper and Mr. Henry Cline.—Principles and Practice of Surgery ; by Mr. Astley Cooper.

At Guy's.—Practice of Medicine ; by Dr. Curry and Dr. Cholmeley.—Chemistry ; by Dr. Marcet and Mr. Allen.—Experimental Philosophy ; by Mr. Allen.—Theory of Medicine, and Materia Medica ; by Dr. Curry and Dr. Cholmeley.—Midwifery, and Diseases of Women and Children ; by Dr. Haighton.—Physiology, or Laws of the Animal Economy ; by Dr. Haighton.

London Hospital.—Lectures on the following subjects will be given at this hospital, to commence in October :—Anatomy and Physiology ; by Mr. Headington.—Surgery ; by Mr. Headington.—Midwifery ; by Dr. Ramsbottom.—Chemistry ; by Mr. R. Phillips.—Materia Medica and Pharmacy ; by Mr. R. Phillips.

Middlesex Hospital.—Dr. P. M. Latham and Dr. Southey will begin their Lectures on the Practice of Physic and the Materia Medica at this hospital, in the first week of October.—Dr. Merriam and Dr. Ley will commence their Lectures on Midwifery, and the Diseases of Women and Children, as usual, early in the month of October.

Mr. Clarke will commence his Course of Lectures on Midwifery, and the Diseases of Women and Children, on Monday, Oct. 6. The Lectures are read every morning, from a quarter past ten to a quarter past eleven, for the convenience of students attending the hospitals.

Dr. Davis will commence his first winter Course of Lectures on the Theory and Practice of Midwifery, and on the Diseases of Women and Children, Oct. 7, at six o'clock in the evening.

Dr. Clutterbuck will begin his Autumn Course of Lectures on

the Theory and Practice of Physic, Materia Medica, and Chemistry, on Friday, Oct. 3, at ten o'clock in the morning, at No. 1, in the Crescent, New Bridge-street, Blackfriars.—Pupils are admitted, as usual, to attend the medical practice of the General Dispensary, Aldersgate-street, and, when qualified, to visit the patients at home.—Clinical Lectures on the most interesting cases that occur will be given at the Dispensary by the Physicians in rotation.

Mr. Good's Course of Lectures on Nosology, Medical Nomenclature, and the Theory and Practice of Medicine, will commence on Monday, Sept. 29, 1817, at the Crown and Rolls Rooms, Chancery-lane. The Course will extend to rather more than three months, and be repeated three times a year. From the comprehensiveness of the subject, a Lecture will be given daily, instead of every other day, as is the common practice. The Introductory Lecture will commence at half past three o'clock in the afternoon; the subsequent Lectures at eight in the morning.

Dr. Adams will commence his Course of Lectures on the Institutes and Practice of Medicine early in October, at No. 17, Hatton Garden.

Mr. R. Phillips will commence a Course of Lectures on Chemistry at No. 66, Cheapside, on Oct. 6, at seven o'clock in the evening.

II. Ores of Cobalt.

The principal ores of cobalt, known in Germany by the names of *kobaltglanz* and *speiskobalt*, are of a very complicated nature; and the analyses of them by different chemists differ so much from each other, that there is reason to suspect them not to be chemical compounds, but rather mechanical mixtures. Cobalt glance crystallizes in cubes, and appears to contain about seven per cent. of iron pyrites. Bernhardt announced long ago his opinion that this small portion of pyrites gave its crystalline form to the cobalt ore; for it is universally known that the primitive form of iron pyrites is a cube; and it has been repeatedly observed that a very small quantity of one mineral gives its crystalline form to a very large quantity of another. Thus the *gres de Fontainebleau* has the crystalline form of calcareous spar, though sometimes the quantity of carbonate of lime which it contains is very small. In like manner it was observed by Bucholz that about three parts of proto-sulphate of iron give their own crystalline form to 100 parts of sulphate of zinc. Stromeyer and Gehlen have announced that arragonite owes its crystalline form to the small quantity of carbonate of strontian which it usually contains.

Stromeyer has lately subjected glance cobalt and speiskobalt to a new and very careful analysis, in order to determine their constitution. He found a specimen of this ore from Skutterud, in Modumkirchspiel, Norway, of the specific gravity 6.2316, composed as follows:—

Arsenic	43·4644
Cobalt	33·1012
Iron	3·2324
Sulphur	20·0840

99·8820

of—

Sulphuret of cobalt	49·3852
Persulphuret of iron	7·0324
Arsenic	43·4644

99·8820

f the sulphuret of cobalt be a compound of one atom cobalt and
 atoms sulphur, then the above analysis indicates seven atoms of
 huret of cobalt, one atom of persulphuret of iron, and about
 at atoms of arsenic.

according to Stromeyer's analysis, crystallized speiscobalt from
 gelsdorf, in Hesse, of the specific gravity 6·449, contains the
 owing constituents :—

Arsenic	74·2174
Cobalt	20·3135
Iron	3·4257
Copper	0·1586
Sulphur	0·8860

99·0012

Arseniuret of cobalt	51·6978
Arseniuret of iron	9·1662
Persulphuret of iron	1·5556
Sulphuret of copper	0·2046
Arsenic	36·3770

99·0012

suspect that Professor Stromeyer's statement of the proportions
 hich cobalt and iron unite with arsenic are rather hypothetical.
 nic is one of the substances which requires further elucidation
 re it can be made to accord properly with the atomic theory.
 present knowledge indicates 4·75 as its weight; but on that
 position the oxygen contained in both its acids must be repre-
 ed by fractionable numbers; for arsenious acid is a compound of

Arsenic	4·75
Oxygen	1·5

arsenic acid is a compound of

Arsenic	4·75
Oxygen	2·5

ow to make these numbers accord with the atomic theory, we
 at suppose that arsenious acid is a compound of two atoms

arsenic and three atoms oxygen, and arsenic acid of two atoms arsenic and five atoms oxygen. But from the constitution of arseniate of lead and arseniate of lime, both of which are accurately known, there can be no doubt that the equivalent number for the weight of an atom of arsenic acid is 7.25. As these determinations do not accord with the above numbers given by Stromeyer, I may state here what the composition of speiscobalt ought to be according to his experiments:—

Arseniuret of cobalt	46.92
Arseniuret of iron	6.36
Persulphuret of iron	1.55
Sulphuret of copper	0.20
Arsenic	44.35
	<hr/>
	99.38

In the course of his experiments Stromeyer satisfied himself that the best mode of separating arsenic from iron is by a current of sulphureted hydrogen gas. When the arsenic is acidified, and thrown down by means of a salt of lead, it carries along with it some arseniate of iron. He satisfied himself, likewise, that cobalt cannot be freed from iron, either by means of caustic ammonia or carbonate of ammonia. The best process for separating these two metals is the addition of some oxalic acid, a method first employed by Tupputi. The whole of the oxalate of cobalt is thrown down, while the oxalate of iron remains in solution.

III. Register of the Weather at New Malton, in Yorkshire.

March, 1817.—Mean pressure of barometer, 29.60; max. 30.30; min. 28.10. Range, 2.20 in. Spaces described by the curve, 8.92 in. Number of changes, 20.—Mean temperature, 40.50°; max. 58°; min. 24°. Range, 34°.—Amount of rain and snow, 0.81 in. Wet days, 5. Prevailing winds, S and W. N, 2. SE, 1. S, 7. SW, 7. W, 10. NW, 2. Var., 2. Number of brisk winds, 5. Boisterous, 3.—Character of the period: clear, dry, and cold.

April.—Mean pressure of barometer, 30.221; max. 30.65; min. 29.60. Range, 1.05 inch. Spaces described by the curve, 6.27 in. Number of changes, 19.—Mean temperature, 44.66°; max. 62°; min. 27. Range, 35°.—Amount of rain and snow, 0.41 inch. Wet days, 2. Prevailing wind, N. N, 14. NE, 2. E, 1. SE, 1. S, 1. SW, 1. W, 5. NW, 4. Var., 1. Number of brisk winds, 3. Boisterous, 1.—Character of the period: dense, fair, and dry, with a very low temperature.

May.—Mean pressure of barometer, 29.630; max. 30.34; min. 29.15. Range, 1.19 in. Spaces described by the curve, 6.14 in. Number of changes, 13.—Mean temperature, 48.75°; max. 64°; min. 33°. Range, 31°.—Amount of rain, 1.88 in. Wet days, 8. Prevailing wind, northerly. N, 8. NE, 5. SE, 2

two, 3. SW, 6. W, 2. Var., 5. Number of brisk winds, 5. Boisterous, 3.—Character of the period: cold and changeable, with a thick and cloudy atmosphere for the most part.

June.—Mean pressure of barometer, 29.634; max. 30.32; min. 29.65. Range, 1.47 in. Spaces described by the curve, 7.46 in. Number of changes, 15.—Mean temperature, 59.50°; max. 82°; min. 42°. Range, 40°.—Amount of rain, exactly 4 in. Total for this year, 9.75 in. Wet days, 15. Winds, light and variable. NE, 3. E, 3. SE, 3. S, 5. SW, 8. W, 3. NW, 1. Var., 4. Number of brisk winds, 3. Boisterous, 2.

From the commencement of this month to the new moon (the 14th) the weather was uncommonly wet, with scarcely an interval of a fair day; and, the temperature having twice risen a little above the regular maximum, was followed by thunder storms. On the 10th the lightning was extremely vivid; and the thunder, which almost instantly followed it, was the loudest that has been heard here for several years. The wind during this storm veered to every point of the compass in less than an hour. From the 13th to the 18th there was a regular increase of temperature, and a similar decrease of pressure. On the 19th the thermometer, from one to nearly four, p. m. indicated 80°; and from seven to eleven in the evening the lightning, which at this place was not accompanied with thunder or rain, was vivid and incessant.

The thermometer indicated 82°, the maximum of the period, on the 20th; 80° on the three following days; and 79° on the 25th. In the afternoon of this day we had another thunder storm, with a few flashes of vivid lightning, and the greatest fall of rain, for the time it continued, perhaps ever remembered here, the amount, as measured from the gauge in about 35 minutes, being equal to a full inch and a quarter. The temperature and pressure again decreased; and heavy showers, with distant thunder at intervals, closed the period.

New Malton, July 1, 1817.

J. S.

IV. *Explosion in a Durham Coal-pit.**

It is with feelings of the most painful nature that we this week find it our melancholy duty to record one of those awful calamities under which this part of the country has so severely suffered, but from which we had fondly hoped that the discoveries of science had nearly relieved us. On Monday last, the 30th ult. about eleven o'clock in the forenoon, the carbureted hydrogen gas in the Row Pit, at Harraton Colliery, on the River Wear, unfortunately ignited, when, our readers will learn with regret, that no fewer than 38 men and boys lost their lives from the violence of the blast. It is described to us as one of the most violent explosions

* Copied from the Newcastle Chronicle of July 5.

which has happened for years; corves, trams, and several utensils used at the bottom of the pit, being blown into the air, together with the bodies of two of the unfortunate workmen, one with the head off, and the other cut in two in the middle. There were 41 workmen down the pit at the time of the explosion; 38 of these have perished, as we have stated; the remaining three are expected to recover. All the sufferers, except one from Fatfield, belonged to New Painshaw, and were buried there on Wednesday afternoon. Amongst them were ten belonging to one family, viz. the grandfather, his two sons, and seven grand-sons. On Tuesday a Coroner's Inquest was held upon the bodies, when, after a patient investigation, the Jury returned a verdict, "that the deceased had got their deaths by an explosion of fire-damp, occasioned by the using of candles instead of the safety lamps, contrary to orders given."— Upon so delicate a subject as the origin of this melancholy accident, we feel ourselves unwilling to say much; but as some notice of it may be expected by our readers, we shall merely state that we understand, from the best authority, it appeared to the Jury that the part of the pit in which some of these men had been set to work that day was not clear of fire-damp. This circumstance was particularly impressed upon them, and they were expressly ordered to use their safety lamps; and to show to them more clearly the necessity of using them, one of the overmen went with a lamp a little in advance of where they were to work, to prove to them that some portion of fire-damp was in their neighbourhood. One man, however, was found who would not attend to these directions, but used a lighted candle, for the workmen prefer a candle to the safety lamps, on account of its giving a greater light. When perceived by the overman, he was instantly ordered to extinguish his candle and light his lamp, which he did. A short time after he was found by the overman again using his candle; for this he was most severely reprimanded, and ordered to light his lamp. This he did, but the overman had not long left him when the explosion took place in that part of the pit where this man was working; he was one of the sufferers, and it is therefore only conjecture that he had again reverted to the use of his candle.

But the painful narrative does not close here: on Wednesday afternoon some of the workmen went into the Nova Scotia Pit of the same colliery, to repair some part of the pit which had been injured by the explosion in the Row Pit on Monday; and not returning in time, another party of the men went down to seek them, but were obliged to return without effecting their object, being unable to proceed, on account of the great quantity of choke-damp which had entered the workings, supposed from the Row Pit, subsequent to the explosion. The eight workmen who had first gone down were obliged, therefore, to be left to their fate. Their bodies were got out late on Thursday evening; six of them were quite dead; two were still alive, but there were little hopes of recovery.

V. Explosion on Board a Coal Vessel.*

On Friday night, July 4, as the master of a Scotch sloop lying in the Tyne, and just laded with coals, was going to bed, his candle unfortunately ignited a quantity of gas which had collected in the state room, and produced a slight explosion, by which his face and hands were much burnt, and the curtains of his bed set on fire, but they were soon extinguished; another person was also, we understand, much burned. What renders this circumstance the more curious is, the coals were by no means fresh from the pit.

VI. Coal in Russia.

An attempt to raise coal is now about to be made in Russia, under the immediate patronage of the Emperor. The spot fixed upon for this purpose is in the vicinity of Tula, celebrated for its extensive iron-works. Tula is the capital of the government of that name, distant from Moscow 115 miles, and situated on the river Upha, in long. $37^{\circ} 24'$ E. and lat. $54^{\circ} 10'$ N. All the measures were concerted in London with his Excellency Count Lieven, the Russian Ambassador; and on June 20 Mr. Longmire, of Whitehaven, came to London, with an assistant draughtsman, and four pitmen, belonging to Whitehaven, and two borers, previously engaged at Newcastle. They sailed from Gravesend, for St. Petersburg, on July 1—all their equipments for the voyage being on the most liberal scale. They are to winter at Moscow, excepting a few occasional visits to Tula, as the season may allow, and to commence operations as early after that as the climate will permit.

VII. Query respecting the Matter concreted at the Bottom of Coppers.

(To Dr. Thomson.)

SIR,

As I have observed with pleasure that your *Annals of Philosophy* is open to inquiries, however apparently trivial, if at all connected with science, allow me to request the favour of you, or any of your scientific readers, to say by what process can the concreted matter usually formed, in the course of time, at the bottom of coppers in general domestic use, and known by the name of *fer*, or *fur*, be dissolved, so as to leave the metal clear and open for the common methods of polishing and cleaning.

With much respect, yours,

July 24, 1817.

A CONSTANT READER.

VIII. Experiment of Lampadius.

I am indebted to M. Von Mons for an account of the following experiment of Lampadius, which he says is a decomposition of

* From the Newcastle Chronicle of July 12.

muriatic acid. Not being master of the particular views and opinions of M. Von Mons and M. Lampadius, I do not pretend to understand the drift of the experiment; but I think it right to give it to my readers as I received it:—

Into a forged iron tube he puts a mixture of two ounces of iron filings and one ounce of calcined charcoal. To the tube is adapted a Hessian retort containing a mixture of one ounce of fused common salt and two ounces of calcined sulphate of iron. The tube is connected with a pneumatic trough. He heats in the first place the tube to incandescence: then he raises the retort to a white heat. The products are carbonic acid, carbonic oxide, and carbureted hydrogen. The gases are extricated with such violence that they resemble an explosion.

IX. Note respecting the Sugar of the *Acer Pseudoplatanus*.

By W. A. Cadell, F. R. S.

At Carronpark, in the county of Stirling, on March 7 and 8, 1816, incisions were made through the bark of a great maple tree, the *acer pseudoplatanus* of Linnæus, in Scotland called the plane. The tree was about 42 years old. The incisions were made in the bark of the trunk, five feet from the ground. The sap was quite transparent and colourless, and flowed freely, so as to fill in two or three hours a bottle capable of containing a pound of water. At night, the weather being cold, the sap froze, and hung from the bark in icicles. Three bottles and a half were collected, weighing in all 3 lb. 4 oz. Some days after this the flow of the sap from the incisions ceased entirely. In a few weeks after the tree was cut down.

The sap was evaporated by the heat of a fire, and gave 214 grains of sugar, in colour resembling raw sugar; in taste sweet, with a peculiar flavour. After being kept 15 months, this sugar was slightly moist on the surface.

The quantity of sap employed in the evaporation was 24960 gr. (3 lb. 4 oz.); the quantity of sugar obtained from it was 214 gr.: therefore in smaller numbers 116 parts of sap yielded by evaporation one part of sugar.

July 25, 1817.

W. A. CADELL.

X. *Mineralogy and Geology*.

Part I. of a most extensive collection of minerals, consisting of numerous instructive duplicates collected during the last two years on the Continent, for the express purpose of advancing these sciences in this kingdom, by Professor H., a disciple of Werner's (in the suite of the Emperor) who has consigned them to be sold at 1s., 2s. 6d., and 5s. each; several hundred will be exposed to view at once, to obviate the trouble of opening drawers, and those of one price will remain separate from those of another. By Mr. Mawe, No. 149, Strand. Persons desirous to add to their collections have, therefore, an opportunity of obtaining these rare substances at a very moderate expense.

XI. *Correction of a Mistake in the Epitome of Mr. Solly's Paper given in the Account of the Meetings of the Geological Society in the last Number of the Annals of Philosophy.* By S. Solly, Esq.

(To Dr. Thomson.)

SIR,

In transcribing your extract from the transactions of the Geological Society, an error has occurred, which I hope the following statement will enable you to correct.

The short account of Finbo, which I drew up by desire of M. Suedenstierna, does not (as stated in your last number) assert that the granite containing the pyrophyllite, gadolinite, yttrantalite, yttrocerite, thoxide, &c. &c. is situated in one of the ridges of granite gravel or sand oasen, but that it is surrounded by the usual varieties of the gneis, which I do not consider as a stratified rock. When the mica is very abundant, it generally runs in a particular direction; but this appearance of stratification is continually interrupted by a granitic structure rising through the gneis, and crossing it in every direction. For a long time I considered the mica as indicating a dip of the gneis, as it very frequently rises towards the S.E. I expected to meet with older and lower strata in that direction; but these distinctions seem scarcely admissible among the crags of Scandinavia. The headland in which Finbo is situated terminates one of the southern ramifications of the granitic ridge which separates the basin of Lake Silgiar from that of Lake Runn. The former is replete with stratified masses, to which the denominations of floëtz or of transition may be optionally applied. Felspar, siliceous porphyry resting upon sand-stone, extend along the northern side. Calcareous and argillaceous strata predominate along the eastern and southern boundaries. The basin of Runn contains mere loose sand, clay, and gravel. A ridge of the latter extending from Lake Mœlar to Lake Runn, across which there are traces of it upon a chain of islands, induced me to mention the sand oasen, which I consider as bearing evidence of tremendous currents whirled across Scandinavia from N. to S., leaving behind them merely substances of the hardest nature, the immense size of some of the blocks scattered over them, particularly at the southern termination of Lake Runn, also at Afwesta, &c. The manner in which similar fragments of inferior size extend over the south of Sweden, and are formed again upon the opposite side of the Baltic, reaching far inland, and piled up over chalk, sand, clay, vegetable mould, and prostrate forests, seem connected with various phenomena in other parts of Europe. The supposition that the northern regions of the globe have been swept by currents which have subsided as they have receded from the pole, serves to explain the prevalence of siliceous detritus along the Baltic, and of calcareous, marly, and bituminous deposites, around the Mediterranean.

ARTICLE XII.

Astronomical, Magnetical, and Meteorological Observations.
By Col. Beaufoy, F.R.S.*Bushey Heath, near Stanmore.*Latitude $51^{\circ} 37' 42''$ North. Longitude west in time $1^{\circ} 20' 7''$.*Astronomical Observations.*Emission of Jupiter's first satellite, $10^{\text{h}} 11' 00''$ mean time at Bushey.
 $10 12 21$ mean time at Greenwich.*Magnetical Observations, 1817. — Variation West.*

Month.	Morning Observ.			Noon Observ.			Evening Observ.		
	Hour.	Variation.		Hour.	Variation.		Hour.	Variation.	
July 1	8h 35'	24° 31'	04''	—h —'	—° —'	—''	7h 10'	24° 34'	27''
2	8 40	24 30	02	1 35	24 41	22	6 55	24 35	42
3	8 40	24 28	34	1 35	24 41	52	6 45	24 37	09
4	8 35	24 29	36	1 35	24 41	26	6 55	24 34	26
5	8 35	24 31	00	1 35	24 43	28	6 55	24 35	05
6	—	—	—	1 35	24 40	55	6 55	24 33	35
7	8 35	24 31	32	1 35	24 42	06	6 55	24 35	00
8	8 35	24 30	38	1 35	24 39	32	6 55	24 34	09
9	8 30	24 30	50	1 35	24 40	49	6 55	24 35	05
10	8 35	24 31	26	1 40	24 39	42	6 55	24 35	52
11	8 45	24 31	33	1 40	24 43	07	6 55	24 35	23
12	8 40	24 30	34	1 35	24 41	39	6 55	24 34	53
13	8 35	24 32	13	1 40	24 42	52	6 55	24 37	33
14	8 30	24 34	03	1 30	24 42	12	6 55	24 35	34
15	8 40	24 32	46	1 35	24 42	09	6 55	24 34	44
16	8 35	24 30	34	1 40	24 36	52	6 55	24 35	41
17	8 35	24 33	05	1 40	24 42	14	6 55	24 35	19
18	8 35	24 30	42	1 35	24 40	34	6 55	24 36	05
19	8 40	24 32	01	1 45	24 38	55	6 55	24 33	28
20	8 35	24 30	28	1 35	24 43	31	6 55	24 35	45
21	8 40	24 31	12	1 40	24 43	02	6 55	24 36	09
22	8 35	24 31	16	1 30	24 44	26	6 55	24 35	09
23	8 35	24 32	08	1 40	24 42	44	6 55	24 34	19
24	8 35	24 32	57	1 40	24 43	35	6 55	24 34	09
25	8 35	24 31	55	1 35	24 43	28	7 05	24 34	13
26	8 35	24 28	30	1 30	24 43	17	6 50	24 34	24
27	8 35	24 31	42	1 35	24 43	06	6 50	24 33	55
28	8 40	24 32	09	1 35	24 43	17	6 50	24 33	44
29	8 30	24 30	57	1 40	24 42	42	6 55	24 34	33
30	8 35	24 31	17	1 35	24 44	46	7 00	24 34	35
31	8 30	24 30	28	1 35	24 44	25	7 00	24 37	16
Mean for Month.	8 36	24 31	14	1 36	24 42	06	6 55	24 35	45

July 1.—The needles vibrated $21^{\circ} 00'$ between the noon and evening observation.

July 27.—The needles at the morning observation vibrated $12^{\circ} 30''$, which was followed by thunder and rain.

Meteorological Table.

Month.	Time.	Barom.	Ther.	Hyg.	Wind.	Velocity.	Weather.	Six's.
		Inches.				Feet.		
July 1	Morn....	29.302	60°	63°	SE		Hazy	52
	Noon....	29.165	57	88	SE	14.657	Rain	59
2	Even....	28.985	58	65	SW		Drizzle	55
	Morn....	29.153	57	66	WSW		Showery	
3	Noon....	29.305	63	51	W	40.410	Cloudy	66
	Even....	29.412	61	49	W by S		Very fine	51
4	Morn....	29.478	58	64	SW		Cloudy	
	Noon....	29.456	66	53	SSW	10.963	Cloudy	55
5	Even....	29.345	61	66	E		Showery	
	Morn....	29.157	57	88	SW by S		Showery	54
6	Noon....	29.173	63	61	SW by S	14.855	Fine	
	Even....	29.158	59	63	WSW		Showery	63
7	Morn....	29.107	58	70	NW by W		Cloudy	
	Noon....	29.150	63	58	NW	10.628	Showery	51
8	Even....	29.230	51	73	W		Showery	
	Morn....	—	—	—	—	—	—	50
9	Noon....	29.255	66	54	SW by W	17.569	Fine	
	Even....	29.263	59	63	W by S		Showery	67
10	Morn....	29.323	59	60	W by S		Fine	
	Noon....	29.317	66	49	W	15.268	Fine	50
11	Even....	29.325	61	58	W by S		Fine	
	Morn....	29.400	60	52	W by N		Fine	53
12	Noon....	29.402	65	44	W by N	13.619	Fine	
	Even....	29.414	61	47	WNW		Cloudy	55
13	Morn....	29.480	61	55	W		Fine	
	Noon....	29.430	68	44	W	7.027	Sultry	56
14	Even....	29.423	63	52	WSW		Sultry	
	Morn....	29.400	63	50	SE		Very fine	56
15	Noon....	29.370	71	41	Var.	7.034	Cloudy	
	Even....	29.355	64	62	SW by W		Showery	56
16	Morn....	29.345	61	74	SW		Showery	
	Noon....	29.337	67	54	SW	16.477	Cloudy	56
17	Even....	29.335	62	57	WSW		Showery	
	Morn....	29.423	57	80	NW by N		Showery	54
18	Noon....	29.490	63	62	N	5.154	Cloudy	
	Even....	29.520	63	58	Calm.		Very fine	50
19	Morn....	29.544	61	54	SSW		Fine	
	Noon....	29.527	63	52	W	17.548	Cloudy	63
20	Even....	29.443	58	68	WSW		Showery	
	Morn....	29.380	56	69	SW by W		Cloudy	52
21	Noon....	29.165	63	58	Var.	9.511	Showery	
	Even....	29.150	57	60	W by S		Showery	48
22	Morn....	28.800	54	78	WSW		Fine	
	Noon....	28.784	61	57	SW	13.033	Showery	48
23	Even....	28.765	56	65	NNE		Showery	
	Morn....	29.172	54	59	NNW		Fine	49
24	Noon....	29.263	59	49	NW by N	19.800	Cloudy	
	Even....	29.323	58	54	NW by N		Fine	53
25	Morn....	29.400	56	57	NW		Cloudy	
	Noon....	29.425	61	48	WNW	14.133	Fine	53
26	Even....	29.407	57	55	WSW		Cloudy	
	Morn....	29.365	59	63	NNW		Fine	65
27	Noon....	29.400	61	52	NW	15.691	Fine	
	Even....	29.435	58	54	NW		Fine	

Meteorological Table continued.

Month.	Time.	Barom.	Ther.	Hyg.	Wind.	Velocity.	Weather.	Six's.
July		Inches.				Feet		
	Morn....	29-500	58°	55°	NW		Fine	49°
	19 Noon....	29-500	63	50	WNW	12-124	Fine	65
	Even....	29-500	61	50	WNW		Very fine	} 47
	Morn....	29-545	60	50	WNW		Fine	
	20 Noon....	29-540	64	47	W	14-500	Cloudy	65
	Even....	29-540	57	65	SW		Rain	} 54
	Morn....	29-468	58	79	SW by S		Showery	
	21 Noon....	29-433	65	58	SW by S	25-654	Cloudy	67
	Even....	29-390	64	55	SW by S		Cloudy	} 51
	Morn....	29-335	58	82	SW by S		Showery	
	22 Noon....	29-355	66	53	SSW	23-917	Fine	67
	Even....	29-382	61	67	SSW		Showery	} 56
	Morn....	29-460	60	64	WNW		Cloudy	
	23 Noon....	29-500	64	53	Var.	7-707	Fine	66
	Even....	29-530	58	66	NW		Sh. & Th.	} 54
	Morn....	29-600	61	60	SW		Very fine	
	24 Noon....	29-603	65	50	SSW	9-582	Cloudy	68
	Even....	29-603	60	50	SW by W		Fine	} 53
	Morn....	29-567	61	60	SSW		Cloudy	
	25 Noon....	29-563	68	58	SW by S	17-373	Fine	70
	Even....	29-563	63	67	WSW		Fine	} 55
	Morn....	29-467	60	74	SSW		Showery	
	26 Noon....	29-256	61	60	SW by S	19-795	Showery	65
	Even....	29-253	57	80	S by W		Showery	} 51
	Morn....	29-215	58	64	WSW		Cloudy	
	27 Noon....	29-185	55	65	SW	22-210	Showery	64
	Even....	29-223	59	52	W		Fine	} 49
	Morn....	29-400	58	58	W		Showery	
	28 Noon....	29-410	65	47	W	24-598	Fine	66
	Even....	29-472	59	58	W by S		Fine	} 52
Morn....	29-577	59	60	W by S		Fine		
29 Noon....	29-555	63	54	SSW	17-617	Cloudy	66	
Even....	29-462	59	60	SSW		Showery	} 56	
Morn....	29-353	59	59	W		Fine		
30 Noon....	29-350	65	47	WSW	12-726	Fine	67	
Even....	29-328	61	63	W by S		Showery	} 52	
Morn....	29-305	57	61	WSW		Fine		
31 Noon....	29-295	63	50	W	16-217	Showery	64	
Even....	29-284	56	54	W by N		Showery		

ARTICLE XIII.

METEOROLOGICAL TABLE.

187.	Wind.	BAROMETER.			THERMOMETER.			Hygr. at 9 a. m.	Rain.
		Max.	Min.	Med.	Max.	Min.	Med.		
h Mo.									
July 6	S W	29.68	29.59	29.635	70	45	57.5	48	C
7	S W	29.73	29.67	29.700	71	46	58.5	45	
8	S W	29.78	29.73	29.755					
9	S W	29.78	29.73	29.755	75	47	61.0	44	
10	S	29.68	29.66	29.670	76	48	62.0	46	
11	S	29.73	29.66	29.695	73	55	64.0	55	
12	N W	29.88	29.73	29.805	68	48	58.0	43	
13	S W	29.88	29.60	29.740	71	50	60.5	49	13
14	N W	29.60	29.14	29.370	70	52	61.0	65	72
15	S W	29.54	29.06	29.300	70	49	59.5	46	18
16	N W	29.77	29.54	29.655	69	49	59.0	46	
17	N W	29.77	29.73	29.750	71	52	61.5	48	15
18	N W	29.85	29.77	29.810	67	46	56.5	44	
19	N W	29.90	29.85	29.875	69	42	55.5	41	
20	S	29.90	29.81	29.855	72	54	63.0	61	3
21	S W	29.85	29.70	29.775	72	56	64.5	63	4
22	S W	29.85	29.75	29.800	70	52	61.0	40	
23	S W	30.00	29.85	29.925	70	50	60.0	52	7
24	S W	30.00	29.95	29.975	71	45	58.0	46	
25	S E	29.95	29.80	29.875	72	50	61.0	40	
26	S	29.80	29.60	29.700	66	47	56.5	50	20
27	W	29.85	29.60	29.725	66	47	56.5	40	13
28	W	30.00	29.75	29.875	68	48	58.0	39	10
29	W	29.75	29.69	29.720	70	50	60.0	45	14
30	W	29.75	29.67	29.710	71	48	59.5	45	3
h Mo.	S W	29.75	29.67	29.710	71	44	57.5	45	
Aug. 1	S W	29.92	29.75	29.835	69	41	55.0	49	
2	S W	29.92	29.65	29.785		54		50	
3	W	29.75	29.65	29.700	68	46	57.0	54	
4	S W	30.00	29.67	29.835	68	50	59.0	53	
		30.00	29.06	29.743	76	41	59.32	48	1.95

se observations in each line of the table apply to a period of twenty-four hours, beginning at 9 A. M. on the day indicated in the first column. A dash indicates, that the result is included in the next following observation.

REMARKS.

Seventh Month.—6. Some rain, a.m.: windy: twilight orange coloured. 7. *Cumulostratus*: fair. 8, 9. Fair: cloudy: red sunset. 10. Cloudy: calm: a light shower. 11. Cloudy: a light shower, a.m. 12. Cloudy: a light shower early: fair day. 13. Large *Cirri*: fine, a.m.: *Cirrocumulus*: *Cirrostratus*: windy: cloudy: shower, evening. 14. Cloudy morning, followed by several slight showers. 15. Rain in the night, and a wet morning: much *Cirrostratus*, with a pretty calm air: afterwards the *Nimbus* prevailed, with sudden showers; and it was stormy at night. 16. Cloudy: calmer: fair. 17. Cloudy: *Cirrocumulus*: *Cirrostratus*: fair day: rain in the night after. 18, 19. Cloudy: windy: fair: a ruby-coloured twilight, the clouds rapidly dispersing at the time. 20. *Cirrostratus*, alternating with *Cirrocumulus*: then *Cumulostratus* and rain in the evening. 21. Cloudy, windy, a.m.: a fine display of *Cirrostratus* in elevated beds, passing to *Cirrocumulus*.

Eighth Month.—1. Chiefly showery for the last ten days, with thunder three times.

RESULTS.

The wind uniformly westerly, a single observation excepted, which was of short continuance.

Barometer: Greatest height 30·00 inches
 Least 29·06
 Mean of the period 29·743

Thermometer: Greatest height 76°
 Least 41
 Mean of the period 59·32

Mean of the hygrometer, 48°. Rain, 1·95 in.

The period was throughout changeable, cloudy, and windy, the barometer fluctuating (save in one depression) between the limits of 29·5 and 30 inches.

TOTTENHAM,

L. HOWARD.

Eighth Month, 23, 1817.

P.S. The following observation was communicated to me by my friend Thomas Forster, at Tunbridge Wells:—

July 30, 1817.—11^h 30^m, p.m. A fine coloured *parasele*, about 23° ENE of the moon. It lasted about three minutes; and then there broke out from it a tapering or conical band in the direction from the moon, i.e. ENE; and in a minute more the whole disappeared. Features of *Cirrostratus* were discernible at the edge of the thin cloud in which it was seen.

ANNALS
OF
PHILOSOPHY.

OCTOBER, 1817.

ARTICLE I.

A Description of the Laurus Cinnamomum. By Henry Marshall, Esq. Staff Surgeon to the Forces in Ceylon. Communicated by the Right Hon. Sir Joseph Banks, Bart. G.C.B. P.R.S.

(Read at the Royal Society, in March, 1817.)

THE *laurus cinnamomum* belongs to class Enneandria, order Monogynia, of the Linnæan arrangement of plants; specific character, “*foliis trinervis, ovato-oblongis, nervis versus apicem evanescentibus.*”

Roots branchy and ligneous. The bark of the roots has the pungent smell of camphor, with the delicious odour of cinnamon; yields camphor by distillation; wood light, fibrous, and inodorous.

The tree grows to the height of from 20 to 30 feet. Trunk from 12 to 18 inches diameter; irregular, knotty, covered externally with an ash-coloured, thick, rough, scabrous bark; inner bark reddish. The bark of the young shoots is often beautifully speckled with dark green and light orange colours.

Branches numerous, strong, horizontal, and declining. Branchlets cross-armed.

Leaves oblong, from six to nine inches long, and from two to three broad; both ends sub-acute; entire, flat, three-nerved, lateral nerves vanishing as they approach the point; smooth; superior surface dark green, shining; inferior, green; grow in pairs, opposite, crossed.

Petiole half cylindrical, slightly channelled above, about three fourths of an inch long; has the odour and taste of cinnamon.

Peduncles many-flowered, long, lateral, and terminal; flowers hermaphrodite, white; calyx none; corolla six-cleft; stamens nine.

The fruit is an oval berry, larger than a black currant; adheres to the receptacle, like the acorn; the receptacle is thick, green, and hexangular; when ripe, the skin is bluish-brown, thickly scattered with white spots; under the skin is a greenish pulp, slightly acrid, has a terebinthine odour, and tastes in some degree like the berries of the juniper. This pulp covers a thin, tough shell, which contains an oily, soft, pale, rose-coloured, inodorous kernel. The tree emits no smell.

The young leaves have in general a scarlet or light-liver colour, with yellow veins; as they acquire maturity they become olive, then green, and before they fall olive-yellow: mature leaves, when bruised, have a strong aromatic odour, and the biting sharp taste of cloves.

Crows and wood-pigeons devour the berries with great avidity: the productive quality of the seeds remain undestroyed; and by this means the plant is disseminated to a great extent of country, and is found even in the thickest and most impassable jungles.

Buffaloes, goats, deer, and horses, eat the leaves with great eagerness.

The flowers appear in January and February; and the seeds ripen in June, July, and August. The odour of the flowers is to people in general disagreeable; to many it is like the scent exhaled from newly sawn bones; to others, with St. Pierre, "the flowers of the cinnamon-tree smell like human excrement."

The prepared bark of this tree is the highly esteemed spice cinnamon, which is perhaps the most useful, certainly the most generally grateful, of all the aromatics.

Thunberg, who visited Ceylon in 1775, and who has given a fuller account of the cinnamon-tree, and of the preparation of cinnamon, than had been published before his time, appears to have obtained his information respecting the tree chiefly from Burman and the chaliahs, or cinnamon-peelers. He has enumerated a number of sorts of *laurus cinnamomum*. His distinctions are not founded either on an external or internal variation of the plant, but on a real or supposed difference of the taste, flavour, &c. of a preparation of its bark. His first five sorts are the produce of the *laurus cinnamomum*, and have obtained from the chaliahs the following characteristic denominations: *rasse kurundu*, *nai kurundu*, *capura kurundu*, *cahatte kurundu*, and *sevel kurundu*; from the Cingalese adjectives, *rassi* (sweet), *nai* (acrid or snake), *capura* (camphoric), *cahatte* (astringent), *sevel* (mucilaginous). These distinctions are arbitrary and comparative, imaginary, and ill-defined.

Two peelers barely ever agree in giving the same denomination to a similar piece of cinnamon. The diversities of the quality of cinnamon do not appear to arise from any varieties of the plant, but from care and skill in its preparation, the soil and exposure of the

country, the age and health of the plant. The cinnamon-tree is rarely found except on the south and west aspect of the island. It is chiefly procured between Negombo and Matura: beyond these limits the bark is never of a good quality; it has little taste, and is greatly deficient of the spicy aromatic flavour of cinnamon. Even between these limits the cinnamon is not of the same quality: exposure, soil, shade, and other circumstances, have powerful effects in producing a corresponding variety of the excellences and defects of the produce of the tree.

The dawul kurundu of the Cingalese is divided by Thunberg into two species,* and forms his sixth and seventh sorts. His eighth, ninth, and tenth sorts, do not belong to the laurel genus.

The dawul kurundu, nika dawula, and nika kurundu, of the Cingalese (*laurus casia*, Linn.) abounds in many parts of Ceylon.

The trunk of the dawul kurundu is branchy and crooked, leaves ovato-lanceolated, entire, from four to six inches long, and from one to two inches broad: three nerved; the lateral nerves terminate before they reach the point of the leaf, and join the middle one; above the petiole smooth, alternate; upper surface dusky-green; under surface pale grey; petiole half cylindrical; flat above; flowers inodorous, whitish, verticillated, sessile; calyx common; four-leaved; leaves roundish, concave; contains five distinct flowers with short peduncles; corolla six-petalled, ovato-concave, nearly equal; filaments nine, shorter than the corolla; style short; stigma obtuse; berry black, round, and about the size of a large currant. Under the skin of the berry is a bitterish pulp, which separates easily from a thin, fragile, membranous pellicle, that contains an excessively bitter kernel, one seeded.

The bark of the root is extremely bitter; the leaves, and the bark of the trunk, and branches, are bitter, and have in a very slight degree the taste and odour of myrrh.

This is the cannella de matto of the Portuguese, the wilde caneel of the Dutch, and the laurus myrrha of Loureiro.

Dawul kurundu in the Cingalese language means drum cinnamon; and authors have asserted that drums and tubs were made of the wood of this tree. I have not been able to find that any use is made of the dawul kurundu in Ceylon, either in medicine, or for economical purposes.

The karuwa, or karua, of the Malabar coast, has in several botanical works been classed as a synonyme with the dawul kurundu. It has been so classed in Wildenow's edition of the *Genera Plantarum*. Whether we contemplate the ample description of the karuwa by Governor Van Rheede, or examine the quality of its prepared bark, no specific difference can be discovered between the cinnamon-tree of Ceylon and the karuwa of the Tamools.

The similarity of the appellations by the people of Ceylon and

* This division he has copied from Burman, who, from two synonymous appellations for the same plant, made two sorts or varieties of it.

the Malabar coast strongly support this opinion. The Tamool name for cinnamon is *karua puttay*, or bark of the *karuwa*; the Cingalese term is *kurundu potto*, the bark of the *kurundu*, or *kurundu gaha*: one of these terms appears to be a corruption of the other, although it be not evident which of them is the original.

The prepared bark of the *karuwa* is, according to good authority, inferior to the best Ceylon cinnamon. It is, however, allowed to be superior to the produce of the cinnamon-tree which is found in the northern and eastern part of the island.

It is difficult to conceive how the *dawul kurundu* obtained the appellation of *laurus casia* by Linnæus, and had qualities attributed to its bark which it does not in the slightest degree possess. Linnæus appears to have been misled by the works of former botanists. Paulus Hermanus was physician to the Dutch settlements in Ceylon, and was one of the first who described the plants of the island. Many of his descriptions are inaccurate and defective. Burman copied his inadequate description of the cinnamon-tree, but little improved, into his *Thesaurus Zeylanicus*; from which Linnæus transferred it into his *Flora Zeylanica*.

The following circumstance may have very materially contributed to the misconception of Linnæus.

In Burman's Works, Plate XXVII. is delineated a figure of the *laurus cinnamomum*; and another drawing of the same plant, differing in no essential circumstance, is given in Plate XXVIII., but which Burman has by mistake asserted to be the *dawul kurundu*. Burman observes that Herman's description of this plant is obscure and unsatisfactory; and seems to have perceived the incongruity of his own plate with the description added, which is probably chiefly taken from Kerman. It is evident that Burman was undecided in his conjectures respecting the qualities of the *dawul kurundu*, and leaves the subject to be determined by those who had an opportunity of examining the plant in its native soil. Linnæus may by this mistake have been misled, and confounded the two plants by assigning the aromatic qualities of the *laurus cinnamomum* to the *dawul kurundu*, which has perhaps by this means obtained the name of *laurus casia*.

Burman has been equally unfortunate in enumerating two other species of cinnamon under the denomination of *kurundu pelle* and *kurundu ette*. The first term specifies, in the Cingalese language, a young cinnamon plant; the second, the seed or berry of the cinnamon-tree.

Thunberg followed next. It is not evident that he perceived Burman's mistake; he certainly did not rectify it; and his authority has tended to confirm the errors of his predecessors. He seems to have confounded the *dawul kurundu*, *laurus casia* (the *wilde caneel* of the Dutch), with the natural or uncultivated cinnamon-tree which grows spontaneously in the woods. When Thunberg means to describe the prepared bark of the *laurus casia*, he gives the correct distinctive marks of the prepared bark of the trunks and

branches of cinnamon trees too old to afford good cinnamon. He says, "the laurus casia yields a coarse kind of cinnamon, and seems to be merely a variety of the former," (the laurus cinnamomum); again, "It is probable that the coarse and finer cinnamon, or the laurus cinnamomum and casia, are merely different varieties, arising from the climate, and especially from the soil."

Mr. Forbes, in his *Oriental Memoirs*, seems to have also confounded the two plants, and applies the term casia to the laurus cinnamomum. His words are: "The leaves of the casia are smaller than the laurel, and more pointed. Those of the cinnamon still more delicate; the blossoms of both, like the flowers of the arbutus, hang in bunches, white, and fragrant; the fruit resembles an acorn. The young leaves and tender shoots are of a bright red, changing to green as they approach maturity; they taste of cinnamon," &c. This is an exact description of the cinnamon-tree, not of the laurus casia.

The dried leaves of the cinnamon-tree have an olive-yellow colour. They are shining and glossy; thick, crisp, and durable; the three nerves are protuberant on the inferior side of the leaf; they endure for several weeks the heat and rains of a tropical climate, without losing their spicy aromatic taste; they have in a considerable degree the acidity and flavour of cloves. Commelinus informs us that they afford oil of cloves by distillation. They give an excellent simple, and spirituous water, and an essential oil, according to Dr. Dancer. In Cayenne they are employed in the distillation of rum, to improve its flavour.

Is the leaf of the cinnamon-tree the malabathrum folium or folium indicum of the ancients? Tamala patra is the Sanscrit appellation for cinnamon, of which term malabathrum seems to be only a varied pronunciation, or slight corruption. I am aware that some authors are of opinion that the malabathrum folium is the produce of the laurus caryophyllus, laurus kulit cawang, and that others assert that it is the leaf of the piper betel.

The leaf of the piper betel does not possess the qualities ascribed to the folium indicum. When fresh pulled the betel leaf is soft and succulent, and very soon loses its acrid quality. By drying, it becomes thin, flexible, tasteless, and inodorous. The natives rarely use it when more than two or three days pulled. The malabathrum was held in high estimation by the Greeks and Romans as a perfume, and it entered into the composition of their aromatic unguents.

The casia bud of commerce is the fleshy hexangular receptacle of the seed of the laurus cinnamomum. When gathered young, the receptacle completely envelopes the embryo seed, which progressively protrudes, but continues firmly embraced by the receptacle. The buds have the appearance of nails, with roundish heads of various sizes. If carefully dried, the receptacle becomes nearly black, and the point of the berry light-brown. The seeds contract by drying, and often fall out; the receptacle is then cup-shaped. When long kept they have a dirty-brown colour, and possess very

little of the aromatic flavour of cinnamon. The Tamul name for casia buds is sirnayapoo or sirnahapoo; Cingalese, kurundu ette; Dutch, kassia bloemen; French, fleurs de la cannelle.

Casia buds possess the same properties with cinnamon, though in an inferior degree. By distillation they yield an essential oil, not inferior to that which is prepared from cinnamon.

The confectioners use them in the composition of conserves.

Casia buds are not prepared in Ceylon.

By decoction, the ripe seeds yield a suety substance, which is perfectly inodorous, and has no very considerable degree of inflammability. The natives sometimes extract this substance, and employ it as a liniment for external bruises, &c.

Cinnamon thrives best in a situation rather elevated, and in a sandy loam, mixed with the earthy remains of decayed vegetables. In the rubbishy soil near houses it is uncommonly succulent. The shelter afforded by buildings appears to contribute to its luxuriance.

The ground for planting cinnamon is in the first instance prepared, by cutting down the low brush-wood and young trees. The lofty trees are allowed to remain, as the cinnamon is observed to thrive better under their shade, when not too close, than when it is exposed to the direct rays of the sun. The brush-wood is collected into heaps, and burned. The planting commences when the seeds are ripe, generally during the months of June, July, and August. The workmen stretch a line upon the ground, along which they with a mammettee (hoe) turn up about a foot square of earth, at intervals of six or seven feet. The ashes of the burned shrubs and branches of trees are then spread upon the spots of friable earth; and into each of them four or five cinnamon berries are planted with a dibble. Branches of trees are spread upon the ground, to prevent the friable earth from being scorched, and to protect the young shoots. The young shoots appear above the ground in about 15 or 20 days. Sometimes the berries are sown in nurseries, and the shoots transplanted in the months of October and November.

In favourable situations the shoots attain the height of five or six feet in about six or seven years; and a healthy bush will then afford two or three shoots fit for peeling. Every second year from four to seven shoots may be cut from a bush in a good soil. Thriving shoots of four years' growth are sometimes fit for cutting.

As four or five seeds are sown in one spot, and as in most seasons many of the seeds germinate, the plants grow in clusters, not unlike a hazel bush. In seasons with little rain many of the seeds fail, and a great number of the young shoots die; so that it is frequently necessary to plant a piece of ground several times successively. A plantation of cinnamon, even on good ground, cannot be expected to make much return before eight or nine years have elapsed.

The plantations from which a considerable part of the cinnamon is procured are Kaderang, Ekele, Marendahn (Colombo), and Morotta.

These are styled protected plantations, to distinguish them from

a number of extensive fields that were planted with cinnamon by the Dutch, and which have since been permitted to be overrun with creepers, brush-wood, &c. and many of the cinnamon plants rooted up by the natives.

Kaderang is situated in the neighbourhood of Negombo, and contains about 4,106 acres. A few small pieces of ground belonging to private individuals are included in this statement. A very considerable portion of this plantation is marshy and unproductive. There are about 1623 acres which bear cinnamon; and this number is annually increasing. Kaderang, on an average of ten years, produces annually about 535 bales of cinnamon.

Ekele is situated 10 miles north from Colombo, and contains about 1598 acres of ground of an excellent soil, which is not entirely planted; but the cinnamon is reckoned to be of the finest quality. The annual produce is about 341 bales.

Marendahn is situated in the immediate vicinage of Colombo, and contains (including a number of small fields belonging to private individuals) about 3824 acres of ground well adapted for the cultivation of cinnamon. More attention has been paid to this plantation than to any of the others: it is nearly completely planted, and produces annually about 1124 bales.

Morotta lies seven miles south from Colombo; and is about the same extent as Ekele. Little attention is paid to the cultivation of this plantation. It yields annually about 218 bales.

The jungle and neglected plantations in the neighbourhood of Colombo and Galle afford a large quantity of excellent cinnamon.

The Candian country has continued to furnish annually a quantity of cinnamon. The King did not grant permission for the chaliahs to enter his territory; but they contrived to make short excursions into it; and by stealth, bribery, or sufferance of the headmen, succeeded in obtaining a considerable quantity of bark, which they prepared at their leisure, after leaving the Candian limits: occasionally they suffered for their temerity, but not often.

On an average of 10 years the quantity of cinnamon deposited annually in the magazine at Colombo from the jungles and abandoned plantations of our own territory, including what has been collected in the Candian country, amounts to 1184 bales; and at Galle, during the same period, 935.

The peeling commences early in May, and continues until late in October. The rains which precede, and occur during the southwest monsoon, produce such a degree of succulency in the shoots as to dispose the bark and wood to part easily. The setting in of the rainy weather immediately produces a fresh crop of scarlet or crimson-coloured leaves.

The cinnamon harvest begins by dividing the peelers into small parties, which are placed under the directions of an inferior superintendent. When they are to peel in the plantations, each party has a certain extent of the plantation allotted to it. A few of the party cut shoots; while the remainder are employed in the wada

(or peeling shed) to remove the bark and to prepare the cinnamon. When the chaliah perceives a bush with shoots of a proper age, he strikes his ketta (which resembles a small bill-hook) obliquely into a shoot; he then gently opens the gash, to discover whether the bark separates easily from the wood. Should the bark not separate easily, the shoot or branch is not deemed fit for cutting. The chaliahs seldom trust implicitly to any external mark of the proper condition of the plant, and rarely try a shoot until the scarlet leaves have assumed a greenish hue. Some plants never acquire a state fit for decortication. Shoots of many years' growth often bear the marks of numerous annual experiments to ascertain their condition. Unhealthy, stunted plants, are always difficult of decortication; and the cinnamon procured from them is generally of an inferior quality.

The peelers do not cut shoots or branches whose diameter is much less than half an inch, or more than from two to three inches.

To remove the bark, the peeler commences by making with his kokette, or peeling knife, through the bark, a longitudinal incision, of which the length is determined by the figure of the shoot. A similar incision is made on the opposite side of the shoot, and when the branch is thick the bark is divided in three or four places. The kokette is next introduced under the bark, which is gradually separated from the wood, and laid aside. When the bark adheres firmly to the wood, the shoot is strongly rubbed with the handle of the kokette. These sections of bark are carefully put one into another, the outer side of one section being placed in contact with the inner side of another, and are then collected into bundles, and firmly pressed or bound together.

In this state the bark is allowed to remain for 24 hours, or sometimes more; by which means a degree of fermentation is produced that facilitates the subsequent operation of removing the cuticle. The interior side of each section of bark is placed upon a convex piece of wood, and the epidermis, with the greenish pulpy matter under it, is carefully scraped off with a curved knife. During the operation the peeler sits upon the ground, and keeps the bark steady upon the piece of wood with his heel or toes. The bark dries, contracts, and gradually assumes the appearance of a quill or pipe. In a few hours from the time the cuticle is removed, the peeler commences to put the smaller tubes into the larger, and introduces also the small pieces. By this means a congeries of quills is formed into a pipe, which measures about 40 inches long. The cinnamon is suspended in the wadu upon open platforms for the first day. The second day it is placed in the sun, on wicker shelves, to dry. When sufficiently dry, it is collected into bundles of about 30 lb. weight each, and in this state deposited monthly in the Government magazines at Colombo or Galle.*

* From Baldeus's print of the manner of peeling cinnamon, and also from his description, it would appear that during his residence in Ceylon the bark was removed from large trees, and the trunk allowed to remain uncut. Captain Peshval, who published his account of Ceylon nearly 200 years afterwards, has only

When newly prepared, cinnamon has a most delicious odour: this odoriferous quality becomes gradually fainter. Cinnamon is at first a light-orange colour, which becomes a shade darker by exposure to the air. The bark of old trees acquires a reddish-brown colour.

Shortly after the cinnamon is deposited in the store-houses, the inspection of it commences. The East India Company employ an inspector and two assistants to superintend the sorting and baling of the cinnamon. The manipulation is performed by natives. Each bundle is placed on a table or large bench; the bundle is untied, and the cinnamon examined quill by quill. It is divided into a first, a second, and a third, or rejected sort. The first and second sorts are alone deemed of a quality fit to form the Company's investment. The sorting of cinnamon consists chiefly in detecting or separating what is coarse, and otherwise of a bad quality, including the impositions of the peelers. This is chiefly performed by inspection. Habit soon enables the people employed to discover by a single glance of the eye what is considered defective. Tasting is very rarely had recourse to.

The bark of the large shoots, or thick branches of trees, produces coarse cinnamon, which is generally rejected by the sorters. This cinnamon is thick, and has a reddish-brown colour, rough surface, loose texture, and is coarse-grained. It breaks short, shivery, and crumbling. When chewed it is disagreeably pungent, feels gritty, ligneous, and sandy, in the mouth.

The peelers occasionally scrape off the external pellicle of this quality of cinnamon. This operation thins the cinnamon and improves the colour, but leaves it with a coarse, rough surface. This quality of cinnamon is always rejected.

Cinnamon prepared from the bark of very young and succulent shoots is rejected. It is light straw-coloured, thin, and almost without flavour or taste; and what little aroma it possesses is very evanescent.

Mildewed or half-rotten and smoky cinnamon is rejected. When the peelers are overtaken with rain at a distance from sheds, the bark they have previously collected ferments, becomes decayed, and inodorous. In such situations they frequently retire to caves, or very confined huts, where they kindle fires, to procure warmth and to dress their food. The smoke arising from these fires often greatly injures the bark, and renders it unfit to be manufactured into good

copied and reduced the Rev. Gentleman's print, and rendered it confused, by including in the same plate another print from the same author, showing the costume of the native women, and their manner of making butter. Many authors subsequent to Baldeus have asserted that the decorticated stump regained a new bark. I was, however, surprised to find the following passage in a manuscript memoir on the cultivation of cinnamon, addressed to Mr. North, while Governor of Ceylon, by Mr. Jonville, Superintendant of Cinnamon Plantations: "Your Excellency remembering that some travellers had advanced that the bark of the cinnamon is taken off the branch growing from the trunk, and that it grows again, ordered me to try that: I did so on several plants; but they all died."

cinnamon. To increase the weight, the peelers sometimes stuff the quills of cinnamon with sand or clayey earth, thick ill-prepared pieces of bark, &c. &c. When these impositions are suspected, the quills are undone, often broken, and the foreign mixtures removed.

This is one of the many causes which prevents the cinnamon from being in quills of nearly equal length. Cinnamon produced beyond the river Keymel on the north, and the Wallawey on the south,* is generally condemned. It is light-coloured, greatly deficient in aromatic flavour, astringent, bitter, and has sometimes a taste similar to the rind of a lemon. Even between these limits the cinnamon produced differs greatly in quality. Differences of soil, and exposure, are very evident causes of a difference in the quality of cinnamon. Shoots exposed to the sun are more acrid and spicy than the bark of those which grow under a shade. A marshy soil rarely affords good cinnamon: It has often a pale yellow shade, approaching to the colour of turmeric. It is loose, friable, and gritty, and its texture coarse-grained. It possesses little of the spicy taste of cinnamon. Very often, however, the cause of the inequality of this spice is not apparent; the bark of different shoots of the same bush have often very different degrees of spiciness.

That which is considered in Ceylon as of the best quality is of a light yellow colour, approaching nearly to that of Venetian gold; thin, smooth, shining; admits of a considerable degree of pressure and bending before it breaks; fracture splintery; has an agreeable, warm, aromatic flavour, with a mild degree of sweetness. When chewed, the pieces become soft, and seem to melt in the mouth.†

The first and second sorts are weighed, and put up into bundles, each weighing 92½ lb. English. Each parcel or bale is firmly bound round with ropes, and then put into double gunnies.

The outside of the bale is marked with the number of the quality of the cinnamon, and the initial letter of the name of the protected plantation from whence it is procured. The bales of cinnamon which are procured in the neglected plantations, the woods of our own territory, or in the Candian country, are marked A. G. (Abandoned Gardens.)

The Company export their cinnamon from Colombo or Galle.

* Good cinnamon is found on the southern portion only of the island. The district which affords it appears to lie to the south of a line stretching from a few miles of Negombo to Panama, a station 18 miles north of Kandy, and from Panama to the neighbourhood of Hambangtotte.

† On an average of 10 years, it appears that about one-sixth of the cinnamon collected has been rejected as unfit to form a part of the Company's investment. The specimens of cinnamon from China which I have seen differ from good Ceylon cinnamon in being darker coloured, rougher, and not so well prepared, denser, and breaks shorter, but without crumbling. It is more pungent, and has a flavour easily distinguishable from Ceylon cinnamon. The taste is harsher; and, when chewed, is more ligneous. Ceylon cinnamon has a delicious sweetness, which is not very perceptible in China cinnamon. Some of the tubes are deficient of the spicy qualities of cinnamon; and sometimes pieces are found which have an astringent and bitter taste.

The interstices between the bales are filled with black pepper. This mode of packing was generally practised by the Dutch, and has been scrupulously adhered to by the English. Thunberg attributes peculiarly useful qualities to the packing with pepper. Accident and economy of tonnage very probably induced the Dutch to adopt this mode of stowing. The ships belonging to the Dutch East India Company appointed to take in cinnamon arrived at Ceylon often half filled with pepper from the Malabar coast. As the cinnamon bales are nearly circular, a considerable saving of tonnage was effected, by removing the pepper, and strewing it among the bales. When pepper happened not to be readily procured, the spaces between the bales were filled with coffee.

The Dutch were less careful in sorting the cinnamon. Thunberg's ludicrous account of the medical men of the colony being employed for several days together in chewing cinnamon has been orally confirmed by the people who had been employed in this duty. At all the stations where cinnamon was deposited "two Doctors" were appointed to "taste the cinnamon." As the inspectors did not unbind the bundles, they had a very limited opportunity of ascertaining the quality of the cinnamon, and none of detecting the impositions and adulterations of the peelers. With the Dutch the peelers incurred blame, and were frequently punished, when the monthly collection of cinnamon was considered defective in quantity; and for successful industry they sometimes received a small premium; hence it became the interest of the peelers to attempt impositions, to increase the weight of their collections. The same practice is followed by the English.

The Directors of the Dutch East India Company complained frequently, in their communications to the Colonial Government, that the cinnamon sent from Ceylon was coarse, and ill-prepared. Sometimes it was so bad that they did not dare to expose it to sale, lest the credit of the Ceylon cinnamon should suffer; and, to prevent its being employed in adulterating cinnamon of a good quality, they were on some occasions obliged to burn it.

On some occasions the Ceylon Government has directed oil to be extracted from the cinnamon, whose quality did not permit it to form part of the Company's investment. The process is simple: the bark is grossly powdered, and macerated for two days in sea-water, when both are put into the still. A light oil comes over with the water, and swims upon its surface, and a heavy oil, which sinks to the bottom of the receiver. The light oil separates from the water in a few hours; but the heavy oil continues to precipitate for 10 or 12 days. The heavy oil, which separates first, is about the same colour as the light oil; but the portion which separates last has a browner shade than the supernatant oil. In future distillations the saturated cinnamon-water is advantageously used, added to sea-water, to macerate the cinnamon. 80 lb. of newly-prepared cinnamon yield about $2\frac{1}{2}$ oz. of oil, which floats upon the water, and $5\frac{1}{2}$ of heavy oil. The same quantity of cinnamon, if kept in

store for several years, yields about 2 oz. of light oil, and 5 oz. of heavy oil.

The prepared bark of the *Laurus cinnamomum* has received a variety of appellations. It has, however, been chiefly known by the terms *casia* and *cinnamon*. The derivation of neither of these terms is well ascertained. It has been asserted that the term *casia*, joined with the Hebrew word *khenah* (which signifies a pipe), is the original of what has been rendered *cinnamon* in the 30th chapter of *Exodus*, and that the word rendered *casia* by our translators is *kiddah*, from *khadh*, to split or divide longways. We read in *Herodotus* that *casia* grew in *Arabia*, but that *cinnamon* was brought thither by birds from the country where *Bacchus* was born, that is, *India*. The term used by *Herodotus* to specify the last of these substances indicates the *cinnamon* we now have, for it signifies the rind separated from a plant,* and evidently points out the bark, under which form we still receive this spice.

Galen was of opinion that *casia* and *kinnamomum* were the produce of different species of plants. He, however, finds great difficulty in marking the distinctions. He says that *cinnamon* resembles the best *casia*; and avows that they are so much alike that it is not an easy matter to distinguish them.

The *cinnamon* mentioned by *Galen* appears to have been small shoots or branches, which were sold wood and bark together, *xylo casia*, *casia lignea*.

The ancients enumerate a variety of sorts of *casia*. Some of the terms employed to denominate this spice specify the mart, or port, where it was to be found; some a particular character, or quality; the origin and import of others are undetermined. Ten different sorts are mentioned in the *Periplus*:—1. *Mosylitick*, from *Mosylon*, a port to which it was brought. 2. *Gisi*; small, esteemed the best. 3. *Ordinary*. 4. *Aroma*; sweet-scented. 5. *Mayla*.

* *Vincent's Periplus of the Erythrean Sea*.—The extreme ignorance of the ancients respecting *cinnamon* may be guessed by the account *Herodotus* has given of the manner *casia* and *cinnamon* were collected. He tells us that *casia* grows in a shallow lake; and that round the borders of this lake there are a number of winged animals resembling bats, which are very strong, and utter the most piercing and dismal cries. The Arabs take great care to defend their eyes from the attacks of these animals, and drive them away: after this precaution, they collect the *casia*. *Cinnamon* is collected in a still more surprising manner. The Arabs themselves do not know from whence it comes, nor the country which produces it. Some people assert that it grows in the country where *Bacchus* was born; and their opinion is supported by strongly probable circumstances. They relate that some very large birds collect quantities of the sprigs and small branches of the plant which we call *cinnamon*, a name we have borrowed from the *Phenicians*. These birds construct their nests with the *cinnamon* twigs upon mountains inaccessible to man. To procure the *cinnamon* twigs, it is asserted that the inhabitants of the country adopt the following artifice. They take the dead carcasses of *beelocks*, *asses*, or *carrion* of any kind, and cut it into large pieces, which they place near to the situation where these birds have constructed their nests. The birds immediately pounce upon this prey, and bear it to their nests, which are not in general strong enough to support this load; the fabric divides; and the pieces of *cinnamon* fall down, are collected, and eventually exported into foreign countries.

6. Molo; both unknown. 7. Scleroteria; hard. 8. Duaka. 9. Kitta. 10. Dacar: all unknown. The two leading species of this spice appear to be the casia fistula, pipe cinnamon, and casia lignea, the tender unbarked shoots. Cinnamon, according to Dr. Vincent, is in a number of languages specified by a term which signifies a pipe, or is accompanied with a qualitative bearing this import. Khinemon besem (Hebrew); casia syrx (Greek); casia fistula (Latin). Many of the modern languages omit the substantive, casia, and specify cinnamon by the conditional adjunct of the ancients. Canella (Italian), from canna (Latin), a reed; cannelle (French); kaneel (Dutch); caneel (Danish); canel (Swedish); canela (Spanish); canella (Portuguese); kanehl (German).

The word casia is by modern authors used in a variety of senses; but as they do not always define it, or explain the specific nature of the substance they intend to describe, it is often difficult to know in what sense they have adopted the term, or to comprehend the nature of the article concerning which they have been writing.

This makes the subject extremely embarrassing. It is, however, very generally used in one or other of the three following meanings. 1. To denote the prepared bark of the laurus casia. 2. To specify the cinnamon procured from thick shoots, or large branches, of the cinnamon-tree, employing it as synonymous with the appellation coarse cinnamon. 3. To denominate the produce of the laurus cinnamomum found in various countries, and to distinguish it from the cinnamon produced in Ceylon.

With regard to the first specification, it is sufficient to mention that laurus casia, dawul kurundu, has been already described, and the distinction between it and the laurus cinnamomum pointed out. It is never decorticated. As to the second, it is well known that the rejected cinnamon, or third sort of that prepared in Ceylon, has been imported into England, and sold under the denomination of casia.*

The third specification seems to be founded in a supposition that the laurus cinnamomum found out of Ceylon is not equal to that which is produced in this island.

The cinnamon plant abounds in various parts of the world; and we have the assertion of people apparently well able to judge, that the cinnamon produced in some of these places is equal to the finest prepared in Ceylon.

Cinnamon seems to be confined to the torrid zone; at least we have no good authority for supposing that it is found much beyond it. Spielman says it is found in Tartary; and many authors have asserted that it grows in China. Spielman's assertion is not supported by any authority which I have seen; and Sir G. Staunton

* The true cinnamon, such as we at present receive, is the produce of young shoots of the cinnamon-tree; and that which we call casia is the prepared bark of old branches of the same kind of trees. Casia is harder, and more woody, than cinnamon. The ancients made use of this quality of cinnamon bark, but we at present reject it.—(See French Encyclopedia, Art. CINNAMOMUM.)

tells us that, with the exception of the camphor-tree, none of the laurel genus grows in China, Osbeck does not include it in his *Flora Sinensis*.

Cinnamon abounds on the Malabar coast; * the island of Sumatra, particularly about the Bay of Tapanooly; † Cochin China; Tonquin, ‡ where it is an article of Royal monopoly; the Sooloo; § Archipelago; Borneo; Timor; the Nicobar and Philippine islands; ¶ the island of Floris; ** and Tobago. †† It has been cultivated in the Brazils, ††† the isles of Bourbon and Mauritius, the Sichelle islands, Guadaloupe, Jamaica, and the northern Circars, §§ the island of Du Prince ||| on the east coast of Africa. The cinnamon plant was introduced into Guiana, in the year 1772, from the Isle of France; subsequently it was transported into the Antilles. In Guiana the inhabitants cultivate it in their gardens, and round their cottages. They prepare cinnamon sufficient for domestic purposes, and transmit a small quantity to France. ***

Prior to the year 1790 it was introduced into Cayenne by the French Government at a very great expense, and recommended to be cultivated by the colonists. ††† Père Labat is of opinion that the bois d'Inde of the French West India Islands is the same species of plant with the *laurus cinnamomum*.

The etymology of the terms cinnamon and casia is not very evident. We are informed by Ribeiro that the Portuguese historians derive the first from the Chinese word sin-ha mama, which is said to mean the foot of a pigeon. This derivation is not satisfactory.

To investigate the origin of a term employed to specify an article of commerce, it is particularly necessary to examine the language of the inhabitants of the countries which produce it, and of the merchants and seamen who trade in the commodity. The consumer very generally adopts the term given to a substance by its cultivator. Sometimes the term employed implies the country of the people who are its importers. It has been asserted that the Chinese were very early and extensive traders in the Indian seas; and

* Nieuhoff, Rheede, Dr. Buchanan, &c. &c. &c.

† Marsden's Sumatra, Eschelskroon.

‡ Loureiro *Flora Cochinchinensis*, Abbe Rochon's *Voyage to Madagascar*, &c. &c. Pinkerton.

§ Dalrymple,

¶ Ribeiro's *Account of Ceylon*, De la Harpe's *Collection of Voyages*.

** Nienhoff,

†† Postlewaite's *Commercial Dictionary*.

††† Jerome de Merolia's *Voyage to Congo*; Ribeiro.

§§ Dr. Forster, Dr. Wright, and Dr. Dancer. In 1785 there were 3000 cinnamon-trees of Ceylon in the Isle of France. (See a Report by M. Ceré, the Superintendent of the Botanical Garden.)

||| Les Portugais ont planté quelques cannelliers tirés des Indes Orientales dans l'Isle du Prince, sur la coté d'Afrique, où ils se trouvent maintenant en abondance, et se sont étendue sur une grande parti de l'isle. (See Laurier, *French Encyclopedia*.)

*** Memoir by L. C. Richard in the *Memoirs of the French Institute*.

††† Report by Jussieu and Desfontaines in the same work. Cinnamon has been successfully cultivated in the island of Dominica by a Mr. Bode. The same Gentleman has succeeded in propagating the clove-tree in Dominica.

Ribeiro, on the authority of the Portuguese historians, states that they imported spices into Ormus, and other ports in the Arabian Gulph. He tells us, also, that the Arabians give the appellation of *lar Chini-Seylane* (the China wood of Ceylon) to the cinnamon produced in Ceylon; while they apply the term *kerfah* to the cinnamon produced on the coast of Malabar, and other countries.

The Persian appellation for this commodity is *dar Chini*. The Hindoostanee term for it is *dar Chinie*. This term might have been applied in consequence of the Chinese importing cinnamon into distant ports; or perhaps, more probably, from merely supplying the merchants with it when they arrived at any of the ports of China. Cinnamon was for a long time imported into Europe under the appellation of China wood.

Herodotus tells us that the term used by him to specify cinnamon was adopted by the Greeks from the Phenicians. Their country, however, did not produce cinnamon; but as they were industrious merchants, and extensive navigators, they may have imported it from the countries where it grew, either in their own ships, or in those of other nations. "Traders from the Arabian coast had probably in all ages frequented the eastern seas, although no record of their voyages of an earlier date than the ninth century has been preserved."*

In Cochin China the cinnamon plant is termed *cay que*. The Chinese appear to have adopted this term, but in some degree modified; they call it *kuei chau*, which, when pronounced by a native of China, sounds like the word *qui sheu* or *qui chou*: *chou* in the Chinese language signifies a tree. That the term employed by the Chinese to specify cinnamon has a foreign derivation, is extremely probable; as it appears that cinnamon is not indigenous in China. It appears very probable that the term *casia* has been derived from either the Cochin Chinese or Malay languages.†

The Malays specify cinnamon by the term *kayu manis* (sweet wood). Marsden renders it *kulet manis* (sweet bark or rind), which may be the appellation employed by the higher classes. The vulgar, however, term it *kayu manis*. There is a considerable consonance in the pronunciation of the terms *casia*, *cay*, and *kayu*, all indicative of the same substance.

The Malays were in early ages an active, enterprising, and commercial people. Their language is very generally employed in the

* Marsden's Introduction to a Grammar of the Malay Languages.

† Valentyn derives the term *casia* from *Casia*, the name of an island in the Persian Gulph, which was for a long period a depot for the productions of India. Here the merchants from Europe found cinnamon, which, according to this author, was by the physicians termed *casia fignea* (*casia wood*). According to Dodoneus, Galea once saw a branch of a tree, one end of which yielded cinnamon, and the other *casia*. The same author informs us that Theophrastus and Pliny confidently believed that *casia* and cinnamon were the produce of the same species of plants, and that whatever difference existed between them, they supposed arose from the circumstance of the former being procured from trees which grow on the hills, and the latter from those which grow in the valleys.

districts bordering on the sea coasts of the islands of the eastern Archipelago, the Malay peninsula, Sumatra, Java, &c. These countries abound with cinnamon, which the Malays exported probably in their own ships, or furnished the merchants of other countries with it, in the ports of the districts where it is found most abundant. This they now do; and foreigners would very probably adopt the Malay term for the article; and by this means, through a succession of traders, the Phenicians, and eventually the Greeks, may have received the terms casia and cinnamon. Casia is not improbably a corruption, or foreign pronunciation; of the Malay term kayu (wood), omitting the qualitative adjunct manis (sweet); and the kinamon of the Greeks may be derived from kayu manis, altered by incorrect pronunciation, or erroneous transcription. The vowel *y* in kayu has the power of a consonant, and in this word has a soft nasal sound, resembling in no inconsiderable degree the usual enunciation of the letter *s* in casia. Orally the Malays frequently confound the sounds of the vowels *o*, *u*, and *a*. They often pronounce the term kayu manis as if it were written kaynomanis or kainamanis, which terms do not differ materially from the ancient kinnamon, or the modern cinnamon, either in the letters, or in the mode of utterance: and they certainly specify the same substance. It is worthy of observation that Moses employs the term sweet (manis) cinnamon.

Plate LXXI. Fig. 1, exhibits the *Laurus Casia* with ripe berries. The Cingalese designate this plant by three different names—Dawul Kurundu, Nika Dawulu, and Nika Kurundu.

Fig. 2 is a traced outline of Burman's 28th Plate, which is a delineation of the Kurundu Gaha, or Cinnamon-tree, in a state of florescence. Burman has erroneously stated this to be a print of the Dawul Kurundu of the Cingalese.

ARTICLE II.

Suggestions for building experimental Vessels for the Improvement of the Navy, with Remarks on the present Mode of Construction, and some Experiments on the comparative Resistance of Water on differently shaped Solids. By Col. Beaufoy, F.R.S.

(To Dr. Thomson.)

MY DEAR SIR,

Bushey Heath, Stanmore, July 22, 1817.

It is reasonable to suppose that in a maritime country like the United Kingdom of Great Britain any endeavour to promote the science of naval architecture will meet with a candid and favourable





reception, especially from those to whom the planning, building, and sailing of our ships and vessels are entrusted. Various have been the plans submitted, from time to time, to the directive Boards of Admiralty and Navy, for the improvement of our ships of war; many of which possessed great science, skill, and ability. But while some were probably not carried into execution on account of the expense of building large ships for the purpose of experiment, others were alike disregarded because of the comparative uncertainty of success attendant on all new plans, and the possibility that the expectations of the projector might not be fulfilled, the too sanguine speculations of the most scientific having but too frequently plunged them into the mass of what are commonly termed schemers. The science of naval architecture is not likely to be benefited in any very material degree but by experiments reduced to practice: consequently should any mode be suggested for the building of experimental vessels without subjecting Government to additional expense, the chief objections which have been made to any intended innovations will be removed. There is a class of vessels belonging to his Majesty's dock-yards, of an unseemly shape and clumsy construction, called lighters. It is proposed that, when any of those now in use require to be replaced, instead of moulding the new after the model of its predecessor, it shall be converted to the purpose of experimental inquiry; because as their fitness for sailing is of no immediate moment in the service in which they are employed, they may be rendered, without detriment to the service, not only adequate to all the purposes for which they were originally intended, but may ultimately lead to important practical advantages. It is proposed that these lighters shall partake of some geometrical figure, or rather of three geometrical figures, under varied combinations and arrangements; namely, the cylinder, sphere, and segment, of a prolate spheroid. We will suppose, in the first experiment, the middle or midships to partake of the cylinder, the bow of the globe, and the stern of the prolate spheroid. In the second, instead of forming the bow of a spherical shape, let it be made more acute, and formed by the revolution of a circular segment: in other words, the fore part will be a portion of a circular spindle. In a third, let the bow be still more acute, by adopting a circular spindle whose length bears a greater proportion to its breadth than in the first instance; proceeding thus until the most advantageous bow is ascertained.

In this plan the length, breadth, and depth, of every vessel is to be the same; and the only variable parts of the vessel will be the middle and bow; the length of the cylindrical part decreasing in proportion as the foremost is rendered more acute. When the most advantageous bow has been determined, the next alteration to be made is in the stern part. This extremity, like the fore part, is to

undergo similar changes till the maximum be obtained.* The reason for not altering the two extremities at the same time is obvious; for should this be done, it would be impossible to say what proportional part of the effect is to be attributed to the altering of the fore part, and what is to be set down to changing the shape of the stern.

Another most material circumstance must also be attended to; that is, the masts, booms, gaffs, bowsprit, and sails, must be the ^{ped} same in each vessel, and the masts stopped at the same distance from the bow of each, measured on the load water-line.

By using the above simple and easily drawn figures in the construction of vessels, the water will not form those numerous eddies and whirls which take place when the vessel's hull is composed of an infinite variety of curves, which cause those particles of the fluid, which, after having acted against the hull, and are perhaps descending, to meet with others moving in a different direction, and thus form innumerable vortices, which impede both the sailing and steering; for, as has been before mentioned in the *Annals of Philosophy*, water meeting with an obstacle in its course endeavours to escape by the shortest road, as shot would do, supposing a vessel suspended by the stem, and a quantity poured on the bow.

Vessels built in the present irregular form, when sailing, are continually exposing a different surface (and frequently an unfair curve) to the action of the fluid, unless the water be perfectly smooth, and the vessel remain upright, or be inclined an invariable angle (circumstances not likely to occur in practice); but these proposed experimental vessels will in all cases expose nearly the same surface and shape to the impulse of the fluid; conditions, it is thought, highly advantageous for facilitating their progress.

Should this paper merit the consideration of those connected with the marine, my intention in writing it will be fulfilled.

Having made these preliminary observations, a draft of two vessels proposed to be built when new lighters are wanted is inserted. (See Plate LXXII. Fig. 1, 2.)

The length of the vessel from the fore part of the rabbit of the stem to the after part of the rabbit on the stern post, measured at the height of the extreme breadth, is 60 feet; the extreme breadth, 20 feet; the draught of water, exclusive of the keel, eight feet, or two-fifths of the beam; the breadth of the keel is nine inches, or $\cdot75$ parts of a foot, of which $\cdot375$, deducted from 10, leaves $9\cdot625$,

* The sailing, particularly the steering, depends in great measure on the shape of that part of the stern called the run; for a vessel full abaft may steer sufficiently well when sailing five knots in an hour, and become difficult to manage when running eight or nine. This is to be attributed to the water not closing in behind, and flowing to the rudder in lines parallel to the keel. The East India ships belonging to the Company would be much improved by attending to this circumstance, and sailing them so much by the head unnecessary, excepting what is caused by the stowing of the provisions and water.

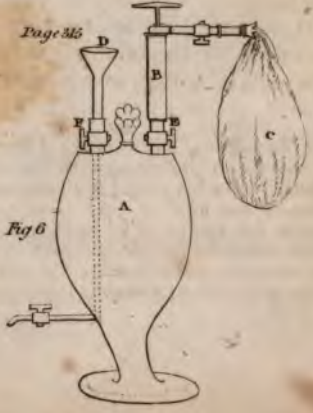
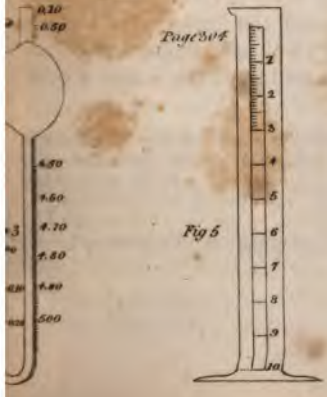
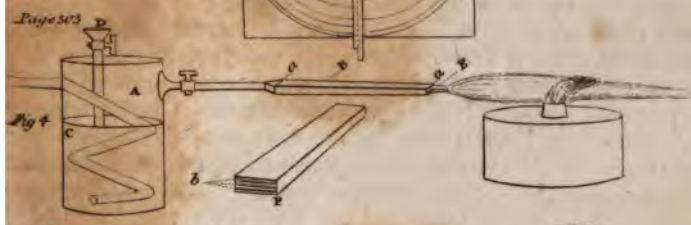
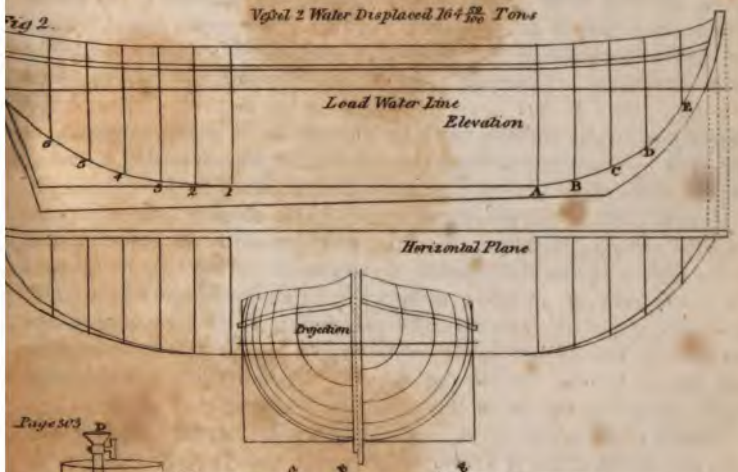
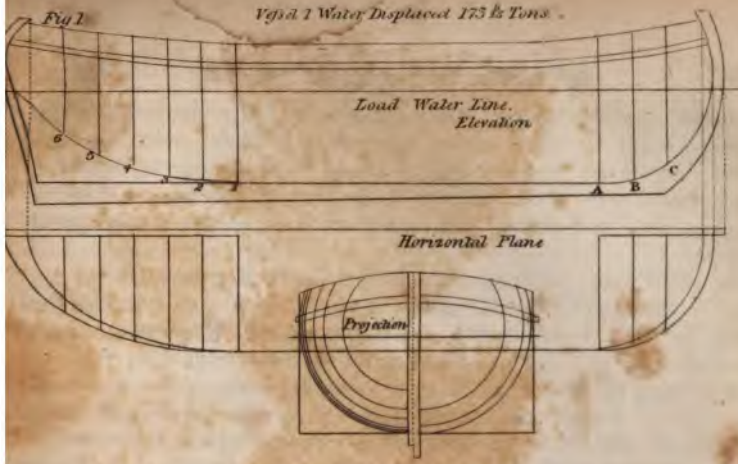



the radius of the midship bend, or greatest vertical section, and also that of the stem, reckoning from the height of the extreme breadth.

The height of the gunwhale above the extreme breadth amidship is two feet, and at each extremity four feet. The vertical curve, or sheer, as it is termed, is described in the following manner. The distance, two feet; the height of each extremity above the middle part of the vessel is divided into as many equal parts as the half length, 30 feet; then, by drawing intersecting lines, a number of points are formed, through which the curve is drawn. The draught of water abaft exceeds that forward by two feet. This difference is caused by making the after part of the keel that quantity deeper, or, as the shipwrights term it, giving so much more skeg.

The dimensions of the three component parts of the first vessel stand thus: length of the fore part, 9·625 feet; midship part, 31·125; and stern part, 19·25. The quantity of water displaced by the vessel is 173·32 tons, a cubical foot of sea water weighing 64·1875 lb. Avoirdupois, and a ton containing 34·8978 cubical feet.

The next point to be considered is the stability of the proposed vessels, and to investigate this most important property. Suppose the vessel, when laden, has its centre of gravity at the load water-line; not that I think it will be so much elevated; but that it is safer, in calculating the stability, to be under the mark than in excess. The centre of gravity is considered to be elevated eight feet above the under side of the garboard strake, or that plank inserted in the keel. It is also taken for granted that the main-sail exposes to the action of the wind 1582·82 square feet; the fore-sail, 339·29; and the large jib, 574·56 superficial feet; * that the vessel is upon a wind; and that the sails make an angle of 35° with the wind's direction. By calculation, the centre of pressure of the three sails is found to be 29·61 feet above the load water-line, by examining the experiments on the resistance of air in the *Annals of Philosophy*, vol. viii. the resistance of a superficial foot exposed to the action of the wind moving with a celerity of 20·29 feet per second, and making an angle of 35° with its direction, is 6·1514 oz.

Avoirdupois, then $\frac{6\cdot1514 \times 2496\cdot67}{16}$ is equal to 959·89 lb., the

force of the wind on the sails, which, multiplied by 29·61, the product, 28422 lb., or 12·689 tons, is the effort of the wind to incline the vessel. To find what inclination the vessel receives by this impulse, we have 959·89 lb., or 0·42852 part of a ton, which, multiplied by 29·61, and divided by 173·32, the tons of salt water displaced by the vessel, the quotient ·073209 is the length of lever on which the displaced water acts to counterbalance the effort of the wind.

The vertical sections or frames, so called by the builders, being

* The quantity of canvas exposed to the impulse of the wind in the sails of the lighters now in use.

segments of circles, the metacentre is in the centre of those circles, and the centre of all the circles being elevated 1'625 foot above the load water-line, $1'625 : \text{radius} :: '073209 : S 2^\circ 35'$, the inclination of the vessel. As the vessel is supposed on a wind, it is evident the power to heel it will be greater than what it was when the vessel remained at rest : it is not improbable this vessel, when under sail, will gain three knots per hour to windward, which is equal to 4'029 feet per second. This number, added to 20'29, gives 24'319, the velocity of the apparent wind, which exerts an inclining power of 18'357 tons. To balance this effort, the vessel must incline $3^\circ 44'$, and the lee side will be immersed $15\frac{3}{4}$ inches. Two other causes, not taken into account, will further incline the vessel, viz. the action of the wind on the mast, rigging, and hull ; and the resistance of the water from the lee way acting against that part of the vessel's body immersed in the water, and situated beneath the vessel's centre of gravity ; but the inclination of the sails from a vertical position will diminish the effort of the wind.

Vessel I.—Bow is the fourth part of a globe at the height of the extreme breadth, and the top sides of the vessel are formed by continuing the curvature of the different circles to the gunwhale.

*Vessel II.**—The horizontal section of this vessel, at the height of the extreme breadth, is the same as the curve of the stem up to that point ; but as the sweep of the stem above that projects forward, and the stern post rakes aft, the upper works, unless the breadth of the vessel be augmented, can no longer be formed by continuing the curvature of the frames or vertical sections of the vessel's hull. Therefore that part of the body above the extreme breadth is formed in the middle or cylindrical part by straight lines, tangents to the midship bend, and other frames of the same dimensions, and the upper works of the fore and after bodies will be thrown outwards, commencing at what may be termed the balance frames, A and I, and gradually increasing till the line terminates in the rabbet of the stem and stern post.

By giving the stern an arched form, it is rendered as strong as the bow ; and, by contracting the after part, the vessel is better adapted for turning to windward ; for the common construction of square sterns and large quarter galleries, by holding a great deal of wind, much impede the ship's progress when turning to windward ; and a vessel of this shape is better adapted either for offence or defence, as guns may be run aft, and pointed more than half round the compass.

The dimensions of the three component parts of Vessel II. will be as follows : length of the fore part, 14'5 feet ; midship part,

* Vessel II., to have the same stability as Vessel I., must have the centre of gravity lowered 1'03 inch. The stem of Vessel II. projecting more than that of Vessel I., this excess of length should be considered as so much bowsprit : consequently it becomes requisite to have more canvas in the fore-sail, and proportionally less in the jib, of Vessel II., that each may contain in the three sails 2496'67 feet of canvas. Models of Vessels I. and II. have been made, and look well.

26·25 feet; and the stern part, 19·25 feet. The capacity of Vessel II. is 164·59 tons, or 8·73 tons less than Vessel I. In determining the power of a machine, it is usual to multiply the weight into the velocity; therefore the momentum of Vessel I. will exceed the momentum of Vessel II., when running with the same velocity; but the increased rate of sailing of Vessel II. will more than counterbalance the diminution of tonnage. For instance, if Vessel I., with a certain breeze, sails with a velocity of 113; and Vessel II., with the same strength of wind, with a velocity of 119; or, what is nearly the same thing, if Vessel II. can make 20 voyages whilst Vessel I. performs 19; both vessels will be equally useful. In other words, the same quantity of freight will be carried the same distance in the same space of time; but should the sailing of Vessel II. exceed this proportion, it is to be preferred to Vessel I.

The builders' tonnage of the King's sailing lighters is $104\frac{1}{4}$. Being ignorant of the weight of the hull, I am unable to state what is the actual displacement of water. If it be supposed, which probably is not far from the truth, that the weight of each of the vessels proposed to be built is 69 tons, the cargo that may be placed on board will amount to 104·32 tons, nearly the same tonnage as the present lighters.

Should it be asked why the force of the wind is calculated with the celerity of 20·29 feet per second in preference to any other velocity, the answer is, that from observation, and by experiment, I found that with that wind square-rigged vessels between 200 and 300 tons burthen under sail, and upon a wind, can just carry top-gallant sails.

These experiments are the more strongly recommended, as it is likely and requisite that some classes of the English navy should undergo considerable alteration; for the large American frigates have taught, by sad experience, how unequal (notwithstanding the desperate bravery of the crews) small vessels are to contend with large ones; and as the Americans of all classes, merchant ships included, are, generally speaking, far superior in point of sailing to our own, it behoves every well-wisher to his country to contribute, as far as he is able, to the improvement of naval architecture and maritime science in general; for such arts and sciences are not only most essential, but absolutely necessary, to the welfare, prosperity, and glory, of Great Britain.

Little doubt can be entertained that a rising floor, in point of sailing, has many advantages over a flat one. Why could not the different tenders that are attached to Admirals, as well as the yachts belonging to the various Boards and dock-yards, also when new ones are wanted, be built as vessels of experiment, making the floors tangents to the curvature of the different frames. By such experiments it appears feasible to expect much valuable and useful information would be obtained, and the groundwork laid for building ships on unerring principles. No doubt the loss of stowage may

be urged against building large vessels with rising floors; but the loss of capacity is readily made up by giving so much more length of midship body as is equal to the capacity lost by acuteness of the floor timbers. It may be also remarked that sharp bottom vessels will not take the ground* so well as flat bottom ones, which certainly is a disadvantage; but it should be recollected that men-of-war are not intended to ground; and taking the ground may be considered like running against a rock, a circumstance to be regretted, but never designed. To conclude, unless ships are constructed with curves of some known properties, it will be in vain to search for the particular parts in a vessel's hull wherein the good or bad qualities they possess are situated. Probably to the heterogeneous curves used in the construction of ships may be traced the shipwright's axiom "that no man can tell how a vessel will sail before it is tried."

It is to be regretted that no experiments on the resistance of fluids, as far as I can learn, are likely to be made in this country; for much remains to be done. Even the elaborate memoir of M. Zaccarie Nordmark, Professor of the University of Upsal, and Knight of the Pole Star, which gained the prize offered by the Royal Marine Department of Russia, is incomplete, as the effect of the friction and minus pressure is not taken into the account: and as the Emperor Alexander, to his great honour, is not only an encourager of travels for promoting the science of geography, but also sends vessels to the most distant parts of the globe on discovery, and at the same time patronizes, in a manner worthy of himself, those arts connected with the marine, why should not a series of experiments be made at our Royal Naval College at Portsmouth? This would enable those students who are to be our future ship-builders to compare the present pneumatical and statical theory with matters of fact.

The Committee of the House of Commons recommended that no false economy might impede continuing the admirable trigonometrical survey so ably conducted by Col. Mudge and Capt. Colby; and the same scientific spirit of liberality would unquestionably encourage an undertaking, the professed object of which is to train up for the public service practical and scientific builders, a class of men no less an ornamental than a valuable acquisition to the kingdom of Great Britain. It is worth recollecting that the building of a single bad vessel will cost five times more money than probably any intended set of experiments will come to.

A comparative set of experiments on the resistance of water is easily made by means of a pendulum; it being only requisite, in the first place, to make each of the solids to be tried of the same specific gravity as water, and then attaching them to the lower extremity of the rod. The pendulum being drawn aside to a certain

* In case of a ship's grounding and bilging, see *Annals of Philosophy*, vol. ii. p. 356.

at, and then let go, it is evident the less the resistance of the shaped body, the greater the ascending arc described by the pendulum, and *vice versa*: consequently the greater or less resistance may be measured by the arc of vibration. Two disadvantages attend this mode of experimenting; the slowness and inequality of the motion, and the passage of the figures through the water not being perfectly lineal.

Subjoined are experiments made in this manner with a pendulum five feet 5.85 inches long, the lower extremity being immersed 12.7 inches.

The solids were two inches in diameter, and as much in length, with the exception of the double cone, which was four inches long, when lengthened by a cylinder, it measured six inches (the same remark is applicable to the elliptical spindle); and the sphere, when cut in halves, and separated by a cylinder, measured four inches.

TABLE I.

Resistance of a cube the angle being opposed to the fluid	1000
Resistance of the side	877
Resistance of a cylinder	1000
Resistance of a sphere	574
Resistance of a sphere cut in halves, and lengthened by a cylinder	238
Resistance of the base of a cone	1000
Resistance of the vortex, its angle being 53.08 ..	467
Resistance of the base of a wedge	1000
Resistance of the vortex, its angle being 53.08 ..	512
Resistance of a double cone	1000
Resistance of the same lengthened by a cylinder ..	380
Resistance of an elliptical spindle	1000
Resistance of an elliptical spindle lengthened by a cylinder *	735

The following table contains experiments made with six different solids, the diameter of each being two inches, and the length seven inches.

TABLE II.

1. An elliptical spindle	1000
2. A circular spindle	847
3. A double circular spindle, greatest breadth $\frac{1}{4}$ from the foremost end	648
4. A ditto, ditto, greatest breadth $\frac{1}{8}$ from the foremost end	603

* It is remarkable that the simple addition of length should so much diminish the resistance, a circumstance fully corroborated by other experiments made in a different manner.

- 5. A ditto, ditto, greatest breadth $\frac{1}{3}$ from the fore-
most end 587
- 6. A ditto, ditto, greatest breadth $\frac{1}{4}$ from the fore-
most end 540

The experiments were compared with each other in the following manner. The ascending arc of the pendulum, before any body was fixed to it, was found by measuring the chord, and calculating the angle to be $19^\circ 5' 39''$, the elliptical spindle being attached to the rod, the ascending arc was found to be $18^\circ 42' 35''$; the difference between those two numbers is $1384''$. This solid being detached, and the circular spindle substituted, the arc of ascension was found to be $18^\circ 46' 07''$, which, deducted from $19^\circ 5' 39''$, leaves 1172. Then $1384 : 1000 :: 1172 : 897$, the comparative resistance of the circular spindle. In the same manner the other comparative resistances are calculated. From these experiments it appears that the extreme breadth should be placed $\frac{1}{4}$ from the bow; but whether this will hold good in all velocities remains to be determined.

It was my intention to have made some remarks on the method of cutting sails; but lest I should intrude too much on your time, I beg leave to subscribe myself,

My dear Sir, very sincerely yours,
MARK BEAUFOY.

ARTICLE III.

Elementary Ideas on the First Principles of Integration, by Finite Differences. By Mr. George Harvey, of Plymouth.

I. SINCE Δ is the symbol which denotes the process of differentiation, let Δ^{-1} be the symbol of the converse operation, by which the integral is obtained. Now, if u be any function whatever, since

$$\Delta(u) = \Delta u,$$

therefore $\Delta^{-1} \cdot \Delta u = \Delta^{-1} \Delta(u) = u$, the *primitive* function.

Again, since $\Delta(u^2) = 2u \Delta u + \Delta u^2$,

and that $2u \Delta u + \Delta u^2$ is a function of u ,

let it be denoted by $O u$, and therefore $\Delta(u^2) = O u$;

hence $\Delta^{-1} O u = \Delta^{-1} \Delta(u^2) = u^2$, the *primitive* function.

To present, however, a more general and comprehensive view of the subject, let u denote, as before, any function whatever; then since

$\left. \begin{array}{l} \Delta u \\ \Delta^2 u \\ \Delta^3 u \\ \dots \\ \Delta^n u \end{array} \right\}$ is derived from the primitive function u by $\left\{ \begin{array}{l} \text{one differentiation,} \\ \text{two differentiations,} \\ \text{three differentiations,} \\ \dots \\ \text{\(n\) differentiations,} \end{array} \right.$

therefore

$\left. \begin{array}{l} \Delta u \\ \Delta^2 u \\ \Delta^3 u \\ \dots \\ \Delta^n u \end{array} \right\}$ ought to reproduce the primitive function u by $\left\{ \begin{array}{l} \text{one integration,} \\ \text{two integrations,} \\ \text{three integrations, (A).} \\ \dots \\ \text{\(n\) integrations.} \end{array} \right.$

Hence, as Δ^{-1} has been adopted to represent the converse operation of Δ , so let Δ^{-2} , Δ^{-3} , \dots , Δ^{-n} denote the converse operations of Δ^2 , Δ^3 , \dots , Δ^n ; and therefore as Δ , Δ^2 , Δ^3 , \dots , Δ^n indicate the *first, second, third, and n^{th} differences* of the *primitive function u* , so will Δ^{-1} , Δ^{-2} , Δ^{-3} , \dots , Δ^{-n} represent the *first, second, third, and n^{th} integrals* of the *same function*.

According to these principles, the formulæ (A) will become

$$\left. \begin{array}{l} \Delta^{-1} \cdot \Delta u \\ \Delta^{-2} \cdot \Delta^2 u \\ \Delta^{-3} \cdot \Delta^3 u \\ \dots \\ \Delta^{-n} \cdot \Delta^n u \end{array} \right\} = u \dots \dots \dots \text{(B).}$$

Geometers, however, have adopted the symbols Σ , Σ^2 , Σ^3 , \dots , Σ^n as characteristics respectively equivalent to Δ^{-1} , Δ^{-2} , Δ^{-3} , \dots , Δ^{-n} , and hence the equations denoted by (B) will be transformed into

$$\left. \begin{array}{l} \Sigma \Delta u \\ \Sigma^2 \Delta^2 u \\ \Sigma^3 \Delta^3 u \\ \dots \\ \Sigma^n \Delta^n u \end{array} \right\} = u.$$

COROLLARY.—Hence it appears that the n^{th} integral of the n^{th} differential of any function is the *primitive function* from which the differential was derived.

II. It is moreover evident, from the preceding principles, that since

Δ^2 may be considered as composed of the two factors Δ, Δ , and is termed the second difference,
 Δ^3 may be considered as composed of the three factors Δ, Δ, Δ , and is termed the third difference,
 \dots
 Δ^n may be considered as composed of the n factors $\Delta, \Delta, \Delta, \dots$ and is termed the n^{th} difference } of the primitive function.

so

Δ^{-2} may be regarded as composed of the two factors Δ^{-1}, Δ^{-1} , and is termed the second integral,
 Δ^{-3} may be regarded as composed of the three factors $\Delta^{-1}, \Delta^{-1}, \Delta^{-1}$, and is termed the third integral,

 Δ^{-n} may be regarded as composed of the n factors $\Delta^{-1}, \Delta^{-1}, \Delta^{-1}, \Delta^{-1} \dots$ and is termed the n^{th} integral,

} of the primitive function;

or by adopting the characteristic Σ , as before,

Σ^2 may be considered as composed of the two factors Σ, Σ , and is termed the second integral,
 Σ^3 may be considered as composed of the three factors Σ, Σ, Σ , and is termed the third integral,

 Σ^n may be considered as composed of the n factors $\Sigma, \Sigma, \Sigma, \Sigma \dots$ and is termed the n^{th} integral,

} of the primitive function.

COROLLARY.—Hence it appears that any *differential*, by the process of *integration*, may be changed into *different* forms; and also an *integral* may undergo corresponding variations by the process of *differentiation*: thus u representing any function, as before, its *second* integral may be denoted by either of the forms

$$\Sigma^2 u = \Delta^{-2} u = \Delta^{-1} \Delta^{-1} u = \Delta^{-3} \Delta^1 u = \Delta^{-5} \Delta^3 u = \&c.;$$

and its *third* integral by either of the forms

$$\Sigma^3 u = \Delta^{-3} u = \Delta^{-1} \Delta^{-1} \Delta^{-1} u = \Delta^{-2} \Delta^{-1} u = \Delta^{-2} \Delta^0 u = \Delta^3 \Delta^{-6} u, \&c.$$

III. By similar operations we may obtain

$$\Sigma^2 \Delta u = \Delta^{-2} \Delta^1 u = \Delta^{-1} u = \Sigma u,$$

$$\Sigma^2 \Delta^2 u = \Delta^{-2} \Delta^2 u = \Delta^0 u = \Sigma^0 u,$$

$$\Sigma^2 \Delta^3 u = \Delta^{-2} \Delta^3 u = \Delta^1 u = \Sigma \Delta^2 u,$$

$$\Sigma^n \Delta^n u = \Delta^{-n} \Delta^n u = \Delta^{n-n} u = \&c.$$

These combinations, it is obvious, may be varied without end.

COROLLARY.—If in the latter form m be *greater* than n , the result will be a *differential* of the function u ; but if m be less than n , then an *integral* of u will be obtained. Suppose, for example, $m = 4$, and $n = 2$,

then $\Sigma^4 \Delta^2 u = \Sigma^2 \Delta^4 u = \Delta^2 u$, the *second difference* of the *primitive* function u ;

but if $m = 3$, and $n = 5$,

then $\Sigma^3 \Delta^5 u = \Sigma^5 \Delta^3 u = \Sigma^2 u$, the *second integral* of the *primitive* function u .

IV. A facility in the management and transformation of these symbols will be of great advantage to the student; and the following examples are therefore added to exercise his ingenuity:—

EXAMPLES ON DIFFERENTIATION.

The *first* difference of $\Sigma \Delta^n u = \Delta \Sigma \Delta^n u = \Delta \Delta^{-1} \Delta^n u = \Delta^n u = \Sigma \Delta^{n+1} u, = \&c.$

The *first* difference of $\Sigma^2 \Delta^n u = \Delta \Sigma^2 \Delta^n u = \Delta \Delta^{-2} \Delta^n u = \Sigma \Delta^n u, = \&c.$

The *second* difference of $\Sigma^2 \Delta^n u = \Delta^2 \Sigma^2 \Delta^n u = \Delta^2 \Delta^{-2} \Delta^n u = \Delta^{-1} \Delta^n u = \Sigma \Delta^n u, = \&c.$

The *nth* difference of $\Sigma \Delta^n u = \Delta^n \Sigma \Delta^n u = \Delta^n \Delta^{-1} \Delta^n u = \Delta^{-1} \Delta^{2^n} u = \Sigma \Delta^{2^n} u, = \&c.$

EXAMPLES ON INTEGRATION.

The *first* integral of $\Sigma \Delta^n u = \Delta^{-1} \Delta^{-1} \Delta^n u = \Delta^{n-2} u = \Sigma^2 \Delta^n u = \&c.$

The *second* integral of $\Sigma \Delta^n u = \Delta^{-2} \Delta^{-1} \Delta^n u = \Delta^{n-3} u = \Sigma^3 \Delta^n u = \&c.$

The *third* integral of $\Sigma \Delta^n u = \Delta^{-3} \Delta^{-1} \Delta^n u = \Delta^{n-4} u = \Sigma^4 \Delta^n u = \&c.$

The *nth* integral of $\Sigma \Delta^n u = \Delta^{-n} \Delta^{-1} \Delta^n u = \Delta^{-1} u = \Sigma u = \&c.$

The *nth* integral of $\Sigma^n \Delta^n u = \Delta^{-n} \Delta^{-n} \Delta^n u = \Delta^{-n} u = \Sigma^n u = \&c.$

The *nth* integral of $\Sigma^n \Delta^n u = \Delta^{-n} \Delta^{-n} \Delta^n u = \Delta^{-n} u = \Sigma^n u = \&c. *$

It thus appears that the symbols usually employed in the differentiation and integration of functions are subject to the ordinary laws of algebraic quantities; an idea which was first elicited by the genius of Arbogast.

By changing Δ into d , and Σ into \int , the preceding remarks are equally applicable to the theory of differentials.

* The utility and importance of these transformations must be obvious; for we can thus pursue the changes which the exponents undergo, through the several states of *positive*, *zero*, and *negative*; the *positive* state denoting the *difference*, *zero* a *constant* quantity, and the *negative* state the *integral*.

ARTICLE IV.

On the Quantity of Real Acid in Liquid Hydrochloric, and on the Composition of some of the Chlorides; with the Description of a new Instrument for the Analysis of the Carbonates. By Dr. Üre.

(To Dr. Thomson.)

DEAR SIR,

IN examining, about two years ago, the magnesian lime-stone of Cultra, in the North of Ireland, anxious to know the quantity of carbonic acid united to the magnesia in this mineral, I found that the common way of analysis would not lead to it with final precision. During its slow solution in dilute muriatic or nitric acids, variable and uncertain quantities of acid vapour were apt to be carried off by the gas, on one hand; or, on the other, a portion of the carbonic acid remained in the liquid. Hence at one time the quantity evolved from 100 grains of the lime-stone was 46; at another, somewhat more; and at another, 45. I observed similar variations, though in a less degree, in the analysis of pure calcareous spar, a substance of the most uniform composition. Nor were the deviations which occurred to me greater than could be paralleled among other investigators. Thus in 100 grains of pure carbonate of lime you state the quantity of carbonic acid at 43·18, from which fundamental number you deduce the weights of the atoms of lime, calcium, and their combinations. Dr. Marcet, a no less accurate philosopher, makes it 43·9; Mr. Kirwan, 45; M. Vauquelin, 43·5; M. M. Aikin, 44; M. Thenard, 43·28: and by Dr. Wollaston's scale it seems to be 43·8 or 43·9. The determination of this point is an essential DATUM in the atomic theory. Of the above analyses, I believe we shall find that of M. Vauquelin to be nearest the truth; though I cannot understand why this excellent chemist should rate the lime at only 56 parts, leaving 0·5 of loss in the 100.

The following experiment, selected from among many others, may perhaps throw light on the cause of these variations. Into a small pear-shaped vessel of glass, with a long neck, and furnished with a hollow spherical stopper drawn out above and below into a tube almost capillary, some dilute muriatic acid was put. The whole being poised in a delicate balance, 100 grains of calc-spar in rhomboidal fragments were introduced, and the stopper was quickly inserted. A little while after the solution was completed, the diminution of weight, indicating the loss of carbonic acid, was found to be 42·2 grains. Withdrawing the stopper, and inclining the vessel to one side for a few minutes, to allow the dense gas to flow out, the diminution became 43·3. Finally, on heating the body of the vessel to about 70°, while the hollow stopper was kept cool,

small bubbles of gas escaped from the liquid, and the loss of weight was found to be 43.65, at which point it was permanent. This is a tedious process.

The instrument which I subsequently employed is quick in its operation, and still more accurate in its results. (See Pl. LXXII. Fig. 3.) It consists of a glass tube of the same strength and diameter with that usually employed for barometers, having a strong prolate spheroid blown on one end of it at the glass-house, and at the other bent upwards with a syphon curve. The middle part between the ball and the bend is about six or seven inches long. The capacity, exclusive of the curved part, is a little more than five cubic inches. It is accurately graduated into cubic inches and hundredth parts, by the successive additions of equal weights of quicksilver from a measure thermometric tube. Seven Troy ounces and 66 grains of quicksilver occupy the bulk of one cubic inch. $4\frac{1}{2}$ such portions being poured in, fill the ball, and a little of the beginning of the stem. The point where it rests is marked with a diamond. Then $34\frac{1}{4}$ grains, equal to $\frac{1}{100}$ of a cubic inch, being drawn up into the thermometric tube, rest at a certain height, which is also marked by the diamond. This bulk is introduced successively, till the stem be filled through the whole extent of the syphon curve; and at each addition a diamond scratch is made.

In the instrument thus finished, $\frac{1}{100}$ of a cubic inch occupies on the stem about $\frac{1}{4}$ of an inch, a space easily distinguished. The weight of carbonic acid equivalent to that volume is less than $\frac{1}{100}$ of a grain, being 0.00232. The mode of using it is perfectly simple and commodious, and the analytical result is commonly obtained in a few minutes.

For example: five grains of calcareous spar, in three or four rhomboids, were weighed with great care in one of Crighton's most delicate balances, such as you have described in the article *Chemistry* of Dr. Brewster's Encyclopedia, though by a typographical error its construction is ascribed to Cuthbertson. These are introduced into the empty tube, and made to slide gently along into the spheroid. The instrument is then held in nearly a horizontal position with the left hand, the top of the spheroid resting against the breast, with a small bended funnel inserted into the orifice. Quicksilver is now poured in, till it be filled, which in this position is accomplished in a few seconds. Should any particles of air be entangled among the mercury, they are discharged by inverting the instrument, having closed the orifice with the finger. On reverting it, and tapping the ball with the finger, the fragments of spar rise to the top. Three or four hundredth parts of a cubic inch of mercury being now displaced from the mouth of the tube, that bulk of dilute muriatic acid is poured in; then pressing the fore finger, armed with a slip of bladder, on the orifice, and inclining the instrument forwards, the acid is made to rise through the quicksilver. This, as it is displaced by the evolved carbonic acid, falls into a

large stone-ware bason, over which the instrument stands in a wooden frame. When the solution is completed, the apparent volume of gas is noted, the mercury in the two legs of the syphon is brought to a level, or the difference of height above the mercury in the bason is observed, as also the temperature of the apartment, and the height of the barometer. Then the ordinary corrections being made, we have the exact volume of carbonic acid contained in five grains of calc spar. In very numerous experiments which I have made, in very different circumstances of atmospherical temperature and pressure, the results have not varied $\frac{1}{100}$ of a cubic inch on five grains, care being had to screen the instrument from the radiation of the sun or a fire.

As there is absolutely no action exercised on mercury by dilute muriatic acid at ordinary temperatures; as no perceptible difference is made in the bulk of air by introducing to it over the mercury a little of the acid by itself; and as we can expel every atom of carbonic acid from the muriate of lime, or other saline solution, by gently heating that point of the tube containing it, it is evident that the total volume of gaseous product must be accurately determined.

Should the substance be more rapidly acted on by a dilute acid than limestone is, we must use some dexterity in sending up the acid, and we must also hold the palm of our hand at first a little above the orifice, to prevent the dispersion of the protruded quicksilver. When a series of experiments is to be performed in a short space of time, I wash the quicksilver with water, dry it with a sponge first, and then with warm muslin. The tube is also washed out and drained.

When a liquid containing gas is to be analyzed, the instrument is slightly modified, by having at the top of the spheroid an orifice shut with a stopper or cork. The mercury is poured in till the instrument is nearly full, the end of the syphon being previously shut with the finger or a cork, and over the mercury the measured quantity of liquid is placed. The top of the spheroid being now closed, dilute acid in suitable quantity is sent up from below, and the evolved gas estimated as before. For a great many purposes I have found this instrument better adapted than the mercurial pneumatic trough. The tubular orifice at the top of the spheroid, and the syphon extremity below, being both nicely graduated, we can measure the quantities of liquid employed, as well as the gaseous product.

I shall in another paper describe a modification of the instrument, well adapted for the practical farmer's and miner's use, in the analysis of marls and lime-stones.

According to my experiments, 100 cubic inches of carbonic acid weigh 46.4 grains. The following table of results is computed on that supposition:—

Grains.		Cub. In.	Per cent. by weight.
5	Calcareous spar yield	4·700	43·616
5	Arragonite from Mr. Jameson	4·670	43·336
7½	Carbonate of strontian	4·885	30·221
	In other specimens of strontianite		30·000
	The above arragonite seems a compound of 97·6 carbonate of lime and 2·4 carbonate of strontian.		
5	Magnesian lime-stone	4·952	45·954
5	Crystals adhering to magnesian lime..	4·700	43·616
5	White Antrim lime-stone	4·650	43·152
5	Pearl spar	4·20	38·976
5	Gall-nut lime-stone	4·68	43·430
5	Carrara marble	4·69	43·523
7½	Ignited subcarbonate of potash	5·075	31·40
5	Subcarbonate of soda	4·403	40·86
4	Dense subcarbonate of ammonia	4·69	54·404

Remarks on the preceding Table.

The crystals adhering to the pieces of magnesian lime-stone I found, by a common analysis, to contain no magnesia. I precipitated by subcarbonate of ammonia, from the acidulous muriate of lime, 99 grains of carbonate from 100 grains of Antrim lime-stone; and 43·152 is to 43·616 as 99 to 100, which is a perfect accordance between the two distinct modes of analysis. The lime-stone in the form of gall nuts clustered together is from the vicinity of Sunderland. It contains a very little oxide of iron, and has a specific gravity of 2·700. It is not a magnesian lime-stone, as some have supposed. The gaseous product shows the absence of magnesia. These gall nuts are denser than common lime-stone, of which the Antrim is of 2·585 specific gravity; the spar is 2·70; the Cultra magnesian lime-stone varnished is 2·157. The subcarbonate of potash was from Tartar; the subcarbonate of soda from ignited bicarbonate, which was found by the ordinary chemical tests to be nearly free from all contamination of muriatic and sulphuric salts, the nitrate of silver giving with its nitrate a scarcely perceptible milkiness. It is a substance, however, difficult to get absolutely pure. The best way of obtaining it which I have yet practised is to boil a solution of pure sea salt with a large quantity of yellow oxide of lead, till no more muriatic acid remains undecomposed. To filter, add a little carbonate of ammonia to the liquid, evaporate, and ignite. The crystallized subcarbonate of commerce, even when found in regular rhomboids, is very far from being pure. It yields, when ignited, only 37½ or 38 per cent. of carbonic acid.

White lead or carbonate will not answer the purpose. I have digested it on a sand-bath with solution of sea salt for many hours without the liquid acquiring the power of reddening litmus paper; but after the white lead is ignited, it begins immediately to decom-

poss the salt with great force. The joint affinities of carbonic acid, oxygen, and lead, and hydrochloric acid and soda, are here shown to be stronger than those of chlorine and lead, oxygen and hydrogen, carbonic acid and soda, which are the divellent forces, opposed to the former as quiescent.

A very pure subcarbonate of soda may also be got from the crystallized acetate by ignition.

Thus accurately acquainted with the composition of the carbonates which I was to employ, the instrument and balance being both of equal delicacy, I next diluted with distilled water at 60° of Fahr. some pure liquid hydrochloric or muriatic acid, in the following proportions. Acid of 1.192 specific gravity, at 60° of Fahr. was employed, equal in dry acid per cent. to 28.3:—

Acid. Grains.	Water. Grains.	Proportions.	Sp. Gr. at 60°.	Temp. on mixture.	Dry acid per cent.
1080	+ 120	= 90 + 10	1.1730	80°	25.47
960	240	80 + 20	1.1536	82°	22.64
840	360	70 + 30	1.1844	85°	19.81
720	480	60 + 40	1.1150	90°	16.98
600	600	50 + 50	1.0960	88°	14.15
480	720	40 + 60	1.0765	83°	11.32
360	840	30 + 70	1.0574	79°	8.49
240	960	20 + 80	1.0384	75°	5.76
120	1080	10 + 90	1.0192	69°	2.83

The calculated and experimental specific gravities at 60° exactly coincide. The mixture of acid and water was made 24 hours before the density was determined, in which interval of time it was frequently agitated. In round numbers we may reckon the addition of $\frac{1}{100}$ of water to acid of any specific gravity as diminishing this by two in the third decimal figure. I shall be able presently to demonstrate, by a series of accurate experiments, that the proportion of dry acid is exact as given above. Hence preceding tables must be wide of the truth.

We may here remark, in the first place, that we have two phenomena somewhat singular in the dilution of this acid. First the evolution of heat from the mixture of two liquids, not saline, without any condensation of their volume. This fact completely disproves the notion, too common in chemical books, that the evolution of heat, in the dilution of alcohol and of sulphuric acid with water, is due to the mechanical effect of the diminution of the pores or interstices which formerly lodged the caloric. The maximum rise of temperature appears above in the mixture of six parts of acid with four of water, which consists nearly in bulk of five of the former to four of the latter. Equal volumes, when mixed, evolve a heat somewhat greater; or by weight, six of acid to five of water.

The second fact is, that we have here a true chemical combination without any change of density. It is curious that the same

proposition holds with gaseous hydrochloric acid, formed by equal volumes of chlorine and hydrogen, which chemically combine while the density is the mean of its components.

What is the origin of the heat in this case? The following experiments will give a satisfactory answer to this question:—

A thin glass globe capable of holding 1800 grains of water was successively filled with this liquid, with the strong acid sp. gr. 1.192, and with that of 1.1152; and being in each case heated to the same degree, was suspended with a delicate thermometer immersed in it, in a large room of uniform temperature. The comparative times of cooling through an equal range of the thermometric scale was carefully noted by a watch in each case. The following were the results:—

Globe with water cooled from 124° to 66°	in 122 minutes
Dilute acid	124 to 66 in 102
Strong acid	124 to 66 in 88

The glass itself had a capacity for heat equal to that of 150 gr. of water. Hence in the three cases we have the following relations between the quantities of matter cooled and the times of cooling:

Water $\frac{122' \times 100}{1800 + 150} = 62.6'$; dilute acid $\frac{102' \times 100}{2020 + 200} = 46'$; strong acid $\frac{88' \times 100}{2154 + 250} = 36\frac{2}{3}'$.

If water be called unity, or 1.000, then the dilute acid is 0.735, and the strong acid 0.586. These numbers represent the specific heats by experiment. But the dilute acid ought, from calculation, to have the mean capacity for heat corresponding to 6 strong acid

+ 4 water, = $\frac{6 \times 0.586 + 4 \times 1.000}{10} = .7516$. We see, therefore,

that the capacity is diminished in the ratio of .735 to .7516, to which cause the evolution of heat is due.

Conceiving that I observed in the successive stages of cooling of the several liquids indications of the relative specific heats varying at different temperatures, I made the following experiments to decide this interesting point. The same glass globe and thermometer were employed:—

Water cooled from	210°	to 150°	in 21.5'
Concentrated oil of vitriol	210	150	17.0
Spermaceti oil, sp. gr. 0.915.	210	150	12.75
Oil of turpentine sp. gr. 0.875.	210	150	11.25
Water	150	90	57
Concentrated oil of vitriol	150	90	39 $\frac{1}{3}$
Spermaceti oil, sp. gr. 0.915.	150	90	29
Oil of turpentine, sp. gr. 0.875.	150	90	25.83

Hence, including the specific heat of the vessel, and the difference of density of the liquids, we get the following equations:—

	Upper Range.		Under Range.
Water	$\frac{21.5'}{1.950} = 11'$		$\frac{37'}{1.950} = 29.2'$
Sulphuric acid	$\frac{17'}{3.085} = 4.6'$		$\frac{30.33'}{3.085} = 10.64'$
Spermaceti oil	$\frac{12.75'}{1.940} = 6.57'$		$\frac{39'}{1.940} = 15.0'$
Oil of turpentine ...	$\frac{11.25'}{1.875} = 6.0'$		$\frac{25.83'}{1.875} = 13.8'$

And reckoning water to be unity, or 1.000,

	Upper Range.	Under Range.
Water	1.000	1.000
Sulphuric acid	0.418	0.364
Spermaceti oil	0.597	0.513
Oil of turpentine	0.545	0.472

The ratios of the sulphuric acid, and of the two oils, are obviously proportional to one another in both ranges; but the specific heat of the water, compared with these bodies, increases in a remarkable ratio as its temperature falls. Had I continued the experiments to still lower degrees of the thermometer, this difference would probably have become greater. But when the substance operated on approached the temperature of the atmosphere, which was then from 55° to 60° Fahr., the cooling was too slow to permit the intervals of time to be marked with the requisite precision.

Hitherto the specific heats of bodies have been compared with that of water either at the freezing temperature, as in the calorimeter of Lavoisier and Laplace, or by admixture, or rate of refrigeration, at very moderate heats. In all these cases the capacity of water, being at a maximum, has caused other bodies to stand relatively low in the capacity scale. The mean capacity of water, between that of freezing and boiling, is probably to be placed at about the hundredth degree of Fahrenheit's scale.

By thus possessing at ordinary atmospherical heats its maximum specific caloric, water is peculiarly fitted for performing its important function of a magazine and equalizer of temperature to the terrestrial globe.

In describing the experiments performed with the view of determining the composition of the chlorides, and the quantity of dry acid in liquid hydrochloric of a certain density, I shall make use of the old language and hypothesis at first, after which the substitution of the new may be readily made.

The point of neutralization between acid and alkali was ascertained in the usual way by litmus paper; but it was occasionally found that a combination would appear neutral by this test when the solution was very dilute, which on concentration gave evident marks of an alkaline or acid excess. To this cause chiefly must we ascribe

a very considerable error, which the celebrated Dr. Black has committed, in his analysis of the Geyser water, as I demonstrated in a memoir on Alkali-metry, subjected about a year ago to the inspection of Dr. Henry, of Manchester. When a saline mixture approaches the neutral state, it is advantageous to touch with the point of a glass rod dipped in pure water, a spot of the paper continuous to that where the combination is applied. The practical philosopher knows well what difficulties attend the actual analysis and synthesis of the salts, when the ultimate precision demanded by the doctrine of multiple proportions is sought for.*

The following experiments are the results of at least a hundred trials. The evaporations were conducted on a nicely regulated sand-bath, in platina capsules, and the dry matter was ignited with a cover, to prevent loss by decrepitation; but very gently, so as to avoid the volatilization of the salt.

Chloride of Potassium.

EXPER. I.—50 grains of recently ignited subcarbonate of potash from tartar, containing 34.3 grains of potash, took for neutralization 700 grains of a diluted muriatic acid, equivalent to 70 grains of that whose specific gravity is 1.192. 54 grains of muriate gently ignited were obtained. As 54 contain 34.3 of potash, 100 grains will consist of 63.52 potash and 36.48 acid. And if 70 grains of liquid acid be equivalent to 19.7 of dry, 100 will contain 28.14. 100 grains of subcarbonate take 140 of the above strong liquid acid for saturation, and yield 108 grains of muriate.

EXPER. II.—50 grains of pure bicarbonate of potash in crystals, equal to 34.5 subcarbonate and 23.67 potash, took 480 grains of dilute acid, equal to 48 of the strong.

37.25 grains of muriate were obtained. As 37.25 is to 23.67 of potash, so is 100 to 63.54 base and 36.46 acid. Here also 100 grains of subcarbonate yield 108 of salt. 100 grains of subcarbonate take in this experiment 159 grains of the strong acid, which gives 28.3 per cent. of dry acid.

A hundred parts of muriate of potash will yield by decomposition with sulphuric acid 129½ of liquid muriatic acid, specific gravity 1.192.

Fifty grains of subcarbonate of potash contain 28.6 potassium, which constitute the basis of 54 of chloride, leaving 25.4 of chlorine. Hence 100 chlorine take 112.6 potassium; or in 100 parts we have 53 potassium + 47 chlorine.

Chloride of Sodium.

EXPER. I.—100 grains subcarbonate of soda, from a recently ignited pure bicarbonate, took for neutralization 183.6 grains of the strong liquid muriatic acid; and 111.7 grains of muriate were ob-

* This is usually, but I humbly apprehend too vaguely, called the doctrine of definite proportions. Definite proportions have been inculcated ever since the fact of saline neutralization was known.

tained. 100 of this subcarbonate contain 40.9 grains carbonic acid and 59.1 soda. Hence 100 parts of muriate are composed of 52.9 soda + 47.1 acid. Here we have 28.6 grains of dry acid in 100 of the liquid.

EXPER. II.—50 grains of a similar subcarbonate took 91.4 of the above liquid acid, and 55.4 of gently ignited muriate were obtained. In 100 parts 53.34 soda + 46.66 acid. Here we have 28.3 of dry acid in 100 of the liquid.

The proportion of dry acid in this last experiment, compared with that deduced from the muriate of potash, shows it to be the more correct of the two experiments on muriate of soda. 100 parts of this salt should yield by careful decomposition 165 parts of liquid muriatic acid of the density 1.190 formerly required by the London College. Extraordinary errors on this subject are to be found in some chemical compilations. Contemplated as a chloride, we have 53.3 soda, equivalent to 39.98 sodium. Hence 39.98 sodium + 60.02 chlorine = 100 chloride. And 100 chlorine combine with 66.61 sodium.

Chloride of Calcium.

EXPER. I.—50 grains of rhomboidal calc spar dissolved in muriatic acid, in a long necked glass vessel, such as was employed also in the above experiments, to prevent loss by effervescence, afforded after careful evaporation and ignition, 55.1 grains of muriate.

EXPER. II.—50 grains of a similar spar yielded 55.4 grains of gently ignited salt.

EXPER. III.—100 grains of pure lime took for neutralization 340.0 grains of the strong liquid muriatic acid, of which 100 grains contain 28.3 of dry acid in the muriates, corresponding to 36.5 of chlorine, as deduced from the preceding chlorides.

It may here be remarked, that to discharge the water, which adheres so forcibly to the muriate of lime, without partial decomposition, is a very nice process. A bright red heat speedily disengages so much of the acid as to enable the watery solution made from that muriate to darken litmus paper. I have repeated the synthesis of muriate of lime more than 50 times, particularly in my researches on magnesian lime-stone, and could not obtain a desirable uniformity of results with a strong heat. Hence Mr. Tennant's process for separating magnesia from lime, by igniting the mixed muriates, is incapable of giving final precision, because the muriate of magnesia requires such an intense heat for its entire decomposition as to affect, more or less, the muriate of lime.

I believe that the mean of the two preceding experiments must be very nearly exact. We may, therefore, consider 100 grains of calc spar equivalent to 110.5 of ignited, but perfectly neutral, muriate. From the above experiments we may deduce, not only the composition of the chloride, but the weight of the atom of calcium.

The atom of carbonic acid is assumed 27.51, oxygen being 10. Now as 43.6 of it combine with 56.4 of lime to form the carbonate, the atom of lime weighs 35.58, and that of calcium 25.58. I con-

ceive that the number 36.20, given by you, is much too great. In round numbers, 35.6 is very near the truth. Therefore 56.4 lime will consist of 15.85 oxygen and 40.55 calcium. Hence 110.5 chloride contain 40.55 calcium, and the remainder 69.95 is chlorine. Or 100 chlorine combine with 58 calcium. The atom of chlorine thence deduced is 44.13.

A hundred grains of calc spar take for saturation or solution 192 grains of the above liquid hydrochloric acid.

Chloride of Silver.

From the mean of several experiments, I find this to be composed of 100 chlorine and 307.5 silver. In one experiment, very carefully conducted, 100 parts of pure silver, sp. gr. 10.717, revived from the muriate, gave 157.66 of dry nitrate, and afterwards of gently fused luna cornea, 132.41. Here 100 parts of chloride contain 24.476 chlorine + 75.524 silver. Or if we state it in the old language, as an oxide of silver, we have 75.523 silver + 18.93 muriatic acid + 5.547 oxygen. Hence 100 oxide contain 7.34 oxygen. This experiment gives 100 chlorine to 303.5 silver.

If we compare together the whole of these experiments, we shall find that muriatic acid, of the sp. gr. 1.192, contains 28.3 parts in the hundred of dry acid.

In the first two experiments on chloride of calcium we have an unexceptionable means of verifying the accuracy of the third. As *their* mean gives the relation of dry acid and lime as the numbers 54.1 to 56.4; then 96.22 of dry acid, present in the 340 grains of the third experiment, should neutralize 100.3 of lime; and the actual number by experiment is 100, a coincidence of the most satisfactory nature.

Mr. Dalton, in the second volume of his new System of Chemical Philosophy, gives a modified copy of Mr. Kirwan's table of muriatic acid, which, he says, is nearly correct. Acid of the sp. gr. 1.192, according to this table, contains only 24.75 of dry acid by weight, instead of 28.3. Having repeated my experiments, with every precaution to ensure accuracy, I am certain that the number 28.3 does not differ from the truth by more than the decimal fraction, provided it differ so much. And in a note to p. 454 of Dr. Henry's valuable System of Chemistry (edition of 1810, vol. i.), we are led to believe that 100 parts of common salt should afford 414 parts of liquid acid, sp. gr. 1.160. Now 100 parts of salt will yield no more, I apprehend, than 186.3 of that density. He takes his data from Berthollet. The difference is no less than 55 per cent.

In the last edition of this deservedly popular work the above note is properly suppressed, and the quantity of acid to be obtained from 100 parts of salt is said to be about equal weights, the acid having a specific gravity of 1.142, that lately prescribed by the London College. Now as this acid contains 21 per cent. of dry acid, we ought to have 220 parts of it from 100 parts of the muriate of soda.

If the table of muriatic acid given by Mr. E. Davy, as deduced

from condensation of the gas, be compared with mine, a near accordance will be found. His acid of 1.190 contains 38.38 of muriatic acid gas in the 100 grains of liquid. At the same density 100 of mine contains 36.5 of chlorine + 1.09 hydrogen = 37.59 of hydrochloric or muriatic acid gas.

I remain, dear Sir, your most obedient servant,

Anderson's Institution, Glasgow,
July 17, 1817.

ANDREW URE.

P.S. In my Experimental Researches on the Ammoniacal Salts, published in the last number of the *Annals*, two typographical errors of importance occur. The first, p. 207, line 7, *members* is printed instead of *numbers*. The second, p. 212, near the bottom, where I endeavour to show the incompatibility of M. Gay-Lussac's experimental results with his theory of volumes, the word *grains* has been improperly inserted after 10. Now, not grains, but volumes, is obviously meant, on the proportions of which, indeed, the whole reasoning of the paragraph hinges. I do not think the word *grains* existed in the copy: the sense is complete without it.

ARTICLE V.

Memoir on the Mode of exploring the Interior of Africa. By H. Edmonston, Esq. Surgeon, Newcastle-upon-Tyne.

(Concluded from p. 112.)

THE ingenious Editor considers the practicability of penetrating beyond the kingdom of Bambarra as not finally settled by the result of Park's journey. If he mean the general point of practicability, he is right. It is not settled. But if Amadou Fatouma is to have credence, and the respectable writer in question inclines that way; and if the reasoning I have employed be correct, the practicability of penetrating much beyond Bambarra by *forcible means* has, one should think, been well nigh settled in the negative for ever. So far from the danger, as this writer alleges, "diminishing as he (Park) advanced," every consideration of prudence, reason, and testimony, lead us to draw an opposite conclusion. It is doubtful how far inward the Moorish dominion extends in Africa. It would seem from the evidence already cited of Amadou Fatouma, that as soon as Park passed the frontier of Bambarra, the country was every where on the alert against him. Of this he must have been too feelingly aware, for he pushed on as if afraid of delay, till at last he was overpowered by numbers, and said to have perished by leaping into the Niger. Indeed, it was scarcely possible that any better termination could ensue from an enterprise so commenced and so constructed. The only wonder is, that it was suffered to proceed so far.

But even allowing, for the sake of those who are determined to shut their eyes to all obstacles and all dangers, that Park and his 50 armed followers had reached the disembogement of the Niger, an event of which there is some reason to imagine the bare possibility, had it not been for the rainy season taking him at a disadvantage; and supposing also, as has been done by one of the first authorities, *Major Rennel*, that this disembogement takes place in a lake or

morass in the interior of the African continent; it by no means follows as a certain consequence that this military expedition could have accomplished its final purpose. Granting that he passed in safety on the Niger, through the territories of Tombuctoo and Houssa, which are conjectured to be the districts to which the Moorish sovereignty is chiefly confined in that quarter, the Moors would be placed between him and the coast, and would not fail to exert all their influence to render ultimate success abortive. In passing rapidly down the Niger, as Park did, it would be impossible to pay tribute to all; and if not to all, the disappointed would, when the opportunity occurred, revenge the omission. In fact, the dissatisfaction of the natives was beginning to manifest itself shortly after his embarkation.

Having, however, as we may admit, attained the great object of all their search, the termination of the majestic Niger, in a lake or morass in the heart of Africa, the expedition must, I presume, find its way back. How this is to be done in a most difficult country, against a current running six miles an hour, I do not well perceive, nor have the advocates for military escort been at pains to explain. It must occupy a considerable time, even admitting the utmost celerity of motion, and the most perfect exemption from every sort of accident, interruption, or molestation. Shall it be said that the pestilential season may not overtake them, in the midst of this laborious navigation? Where and how they are to pass this period of rain and sickness does not clearly appear.

If, on the other hand, we view the whole country as inimical, the canoe to be damaged, and various other casualties, not very unlikely to happen, I suspect, to say the least of it, we shall have but too good grounds for fearing that, even with their fire-arms and their superior intelligence, the individuals composing such an expedition would find great difficulty in extricating themselves from their perilous situation. In fact, Park himself considers the return by the Niger as a thing impossible.

But in truth, even the expectation of ultimate good fortune to such an expedition as Park undertook, and indeed to every military expedition, must proceed upon two assumptions, which, if they do not at last turn out to be absolutely false, are in the mean time so perfectly unfounded in fact, that no enterprize which has the smallest atom of prudence for its basis can be hazarded on the supposition of their stability.

The *first* of these assumptions is, that the River Niger empties its mighty and continuous stream into the sea; a fact of which there is not yet the slightest shadow of proof, whatever the presumptions in its favour may be.

The *second* is, that this immense body of water is easily navigable throughout the whole extent of its course. The direct reverse of this is presumptively, if not directly proved, both by the existence of numerous rapids between Bambakoo and Sansanding, mentioned

by Park himself, and also by the account given by Amadou Fatouma.

For all these reasons, I am afraid we dare not permit ourselves to anticipate any other result than defeat to every enterprize conducted upon similar principles; and extreme danger, if not absolute destruction, to all immediately concerned in it.

While I thus have expressed myself in strong terms of disapproval of all military expeditions to Africa, let me not be denounced by persons who cannot or will not see danger any where, as one of those whom Dr. Johnson has characterized as "of narrow views and grovelling conceptions, who, without the instigation of personal malice, treat every new attempt as wild and chimerical, and look upon every endeavour to depart from the beaten track as the rash effort of a warm imagination, or the glittering speculation of an exalted mind, that may please and dazzle for a time, but can produce no lasting advantage. These men value themselves upon a perpetual scepticism, upon inventing arguments against the success of every new undertaking, and where arguments cannot be found, upon treating it with contempt and ridicule." *Life of Sir Francis Drake.*)

I trust I am neither so wilfully obstinate nor stupid as not to be aware that the accomplishment of every thing great must be attended with great hazard. But I apprehend where the object is interesting to science, and to mankind at large, and especially when the lives of men are to be put in imminent danger, causes of difficulty, even the *most* insignificant, are not to be overlooked. The evil consequences of miscalculation, and of the want of due deliberation, have been already too fatally experienced.

Having enumerated what appears to me to be insurmountable objections to the attempt of penetrating into the interior of Africa by force of arms, I shall next take the liberty of offering some suggestions, calculated, I hope, to effect the purpose of discovery, upon easier, safer, and less costly terms.

I take it as a matter agreed upon by all, that the intellectual qualifications required for a first explorer of Africa are by no means of the highest order. The leading facts to be ascertained in the first instance are the course and termination of the river Niger. To these may be added a few of the principal geographical features, the natural productions, and something of the inhabitants of the country. These particulars are within the compass of any capacity raised a little above mediocrity. A slight talent of observation, good common sense, an expertness at taking the latitude and longitude of places, the altitude of mountains, and a few other requisites, comprise, I should suppose, all that is necessary. To determine where and how the Niger terminates, whether the face of the country be mountainous or flat, the soil moist or dry, the people dark or fair, mild or ferocious, demands not the varied study and complete apparatus of a Bruce, the philosophic research of a

Volney, the knowledge of architecture and antiquity of a Denon, the zoological discrimination of a Pallas, or the profound and extensive science of a Humboldt.* For any immediate purpose, all these points may be as satisfactorily ascertained, and as accurately described by a traveller of moderate abilities, as by any of the celebrated personages whose names have just been cited. The attainments of Hearne, Mackenzie, and Park, were far from being splendid; yet the one determined the course of the copper-mine river, at Hudson's Bay; the other settled the long agitated question of a north-west passage; and the third ascertained the existence and direction of the Niger.

I am the more desirous of directing attention to these things, because, if an imaginary excellence is to be held indispensable, the difficulty of procuring properly qualified persons will be increased to such a degree as to forbid the hope of ever finding them. Individuals of exalted rank in science will not sacrifice their valuable time and labour, unless for such recompence as neither the funds of the African Association, nor the views of Government, will admit of being acceded to.

I notice it for another important reason; namely, to show the little necessity which there is for a first explorer taking with him a complicated geographical apparatus; an incumbrance tending not only to increase the bulk of the baggage, and the difficulty of locomotion, but likewise the dangers of the route, by awakening the jealousies and cupidity of the natives. In fact, it is not required to take any other instruments than a few quadrants and pocket compasses. This was the plan adopted, though imperfectly, by Horneman, who avoided as much as possible every appearance that might give cause of offence or suspicion to the people.

On this part of the subject it was with much satisfaction I found the following opinion given by Jackson in his Account of Morocco. "If their (the African Association's) emissaries have not always been successful, or have obtained information only of minor importance, compared with the great object of their researches, it is to be attributed to their want of a sufficient knowledge of the country, and the character and prejudices of its inhabitants, without which, science to a traveller in these regions is comparatively of little value."

In selecting individuals for the undertaking, it might not be without advantage to descend to minutiae. Of two persons equally well qualified, one of a dark should be preferred to one of a light complexion.

* Of all men, probably Park was, with one exception, the best fitted for an original explorer. Endowed with a hardy constitution, unconquerable intrepidity, unshaken perseverance, great penetration and presence of mind. His only defect was what, under almost any other circumstances, would have been held to be a virtue—an extreme ardour in regard to the success of the enterprise, which prevented his judgment from exercising its due influence in regulating his plans, and anticipating the difficulties reasonably to be expected.

These and other preliminary matters being settled, one, two, or three young men (of whatever number the government appoint) should be chosen. Whether the stations whence the journey is to commence be the Gambia or the Congo, or both, or any other, there should be but *one* traveller to each. This is the more necessary when we recollect that Park's life on his *first* journey was never in danger, unless from physical and other casualties, to which every traveller is liable. He encountered no difficulties, no perils, from which numbers could have saved him, but which would have been augmented fifty fold had he been accompanied by fifty armed men; nor from Isaac's Journal does it appear that his progress was ever seriously impeded, or his life put to any imminent danger.

Each voyager being provided with every necessary on the smallest portable scale, he is to repair to his post. His first object should be to conciliate the favour of the Moorish authorities in the neighbourhood, to form an acquaintance with, and to gain, if possible, the entire confidence of, one or two intelligent Moors; if merchants or priests, so much the better. With their, and such other aid as may be obtained, he should begin to study the language of the country, and the different dialects which may be most necessary on his route,* making himself intimately acquainted with the manners and customs of the inhabitants, and with every particular that may be in the least interesting or important. On his first arrival, it would be advisable to assume the Moorish dress, and to expose himself to the influence of the sun, so as to cause his face, and those parts of the body that are generally exposed in those climates, to put on a tanned appearance. In regard to the subject of dress, on which so much depends, and on which I have dwelled at large in another place, I have again great pleasure in bringing forward the author already quoted:—"When we consider the disadvantage under which Mr. Park laboured in this respect [viz. knowledge of the country and its inhabitants], and that he travelled in a *European dress*, it is really astonishing that that gentleman should have penetrated so far as he did in his first mission; and we are not so much surprised at the perils he endured, as that he should have returned in safety to his native country. Had he previously resided a short time in Barbary, and obtained there a tolerable knowledge of the African Arabic; and, *with the customs, adopted the dress of the*

* Of all the languages to be learned, the Arabic seems to be the most useful. Park on more occasions than one experienced the disadvantages of his deficiency in this most essential point; and even Hornemann, though better versed in it, found that a greater proficiency would have been in his favour. It is this accomplishment which, more than any other, tends to allay the suspicions of the Moors on the score of religion, by convincing them that the person possessing it can read the Koran, that great and indispensable criterion of Islamism: and it is this also that, by working on the religious fears and superstitions of the inferior classes, gives a character of sanctity and importance which nothing else can bestow.—*Quære*: would it be an unjustifiable breach of morality to practise a few of the external and minor ceremonies of Islamism, in order to mislead the fanatical

country, what might we not have expected from his perseverance and enterprising spirit? Whatever plans future travellers may adopt, I would recommend to them to lay aside the dress of Europe; for besides its being a badge of christianity wherever he goes, it inevitably exposes him to danger; and it is so indecent in the eyes of the Arabs and Moors, that a man with no other clothing than a piece of linen round his middle would excite in them less indignation." (Jackson.)

In order to acquire these preparatory requisites, it is obvious that a prolonged residence will be necessary. During this residence he should, in company with his Moorish friends, make occasional excursions to different parts in the neighbourhood, investigating points of natural history, and other circumstances connected with the objects of his journey. The knowledge of these points, if nothing else should be gained, would be valuable. But, what is of more consequence, he would thus, on the small scale, habituate his mind to the duties of his mission, to the difficulties, and the means by which they are to be successfully met. His constitution would become inured to the climate and food, his plans would be gradually unfolded, and all unfavourable suspicions of his designs removed. This, it is well known, is a matter of some moment. Horneman experienced much annoyance on account of it; and Jackson informs us that "no people under heaven are more jealous or more suspicious of every thing which they do not comprehend than the Africans."

Having remained a sufficient time to acquire all the previous qualifications; having estimated the characters of his Moorish friends, and ascertained in whom confidence is to be placed, the next point of importance is to determine what form the expedition is to assume. Perhaps it may be advisable for him to choose one or two Moors as guides, or part interpreters, or rather as attendant merchants or priests, for the purpose of engaging the attention of the natives, particularly the Moors, and leaving the traveller at leisure to make his observations.* Some such arrangement will appear the more necessary, for we find Park, instead of having time to pursue the objects of his journey, continually occupied with measures for the preservation of his property and life.

* Jackson does not approve of the confidence which Hornemann placed in his African fellow travellers; and he thinks that he was too sanguine in his expectations. But it is not the casual acquaintance of a Shereef in a caravan, as in the case of Hornemann, that is here insisted on. Jackson says that he had written "several remarks on Mr. Hornemann's Journal, which he intended to give in an Appendix; but as they might create ill-will, and involve him in useless controversy, he had suppressed them." It is hardly to be granted him that the controversy would have been a useless one. The remarks of so intelligent an observer must have been valuable; and if they had related to Hornemann's mode of exploring the country, it is to be regretted that they were not given. They might have been some guide to the leaders of the last expeditions. However, it is to be hoped that so competent an authority as Mr. Jackson has not been left unconsulted on such an occasion.—From what he says, Morocco would appear to be a favourable point from which to proceed on a journey to the interior.

Hornemann assumed the character of a Turkish merchant; and had he shown sufficient address in supporting the character, there is reason to believe that it would have saved him from all interruption. As it was, he was only once in danger, and then from his indiscreet curiosity in examining some ruins, which led the ignorant and bigotted Mahometans to suspect that he was in reality a different person from what he gave himself out.

Probably the most eligible plan would be for the traveller to appear in some subordinate capacity, and leave the distribution of tribute, and in general the economy of the coffee, to his Moorish companions. In the history of Hearne's journey in North America there are many apposite illustrations of the advantage of this mode of travelling among barbarous tribes. Of all these arrangements, however, the traveller himself will be best able to judge correctly, from his own observation on the spot.

Since Government patronizes these expeditions, they should be carried on upon a scale worthy of a great country. Every exploit which has in view to extend the sphere of natural knowledge, and to enlarge the stock of national wealth, is deserving of liberal encouragement. Frugality ceases to be a virtue when it is exercised in starving exertions which are intended to benefit both the present age and posterity. Every department of the expedition ought to be furnished with a munificence that should leave nothing to be desired. Those Moors who may be induced to accompany the mission should be encouraged by the assurance of rich rewards for their services. Articles of agreement should be entered into conformably to the legal forms of the country, by which provision should be made for the permanent support of their families in case of death, or any other misfortune, and an increase of remuneration in case of success. In short, no expense should be spared, when it is considered that a fortunate result must depend chiefly on their fidelity; and if they fail in their duty from any mistaken parsimony in the previous arrangements, the whole expense may be regarded as thrown away.

While other preparations are going forward, it would be well for Government, through its Ambassadors and Consuls at all the Turkish and Moorish States in Europe, Asia, and Africa, to obtain every sort of recommendation necessary to ensure, as far as that can be done, a favourable reception from the Moorish authorities in the interior. Political influence, religious prejudices, every means should be laid hold of to promote the object in view. It was in this way, and *this alone*, that Bruce succeeded in Egypt and Abyssinia. Had he not been supplied with letters and rescripts from religious and civil authorities, which at the time of receiving them he regarded as superfluous, in all likelihood he must have fallen a victim to the barbarity of those among whom he travelled. "His mode of travelling was peculiar to himself. He omitted no opportunity of securing the means of safety in foreign countries, by methods which other travellers have often neglected, to their great disadvantage." (Preface to Bruce's Travels.)

The party, consisting of as small a number as possible, should carry with them such arms only as are required for their defence, in case of any sudden attack of men, or wild beasts, or for procuring food; and it would seem highly expedient that they lay in no other kind of tribute than what the Moorish coffles or the slatees are in the daily habit of taking.

Much caution will be required, when the party sets off, to prevent its departure and its intentions from being bruited abroad. Some idea may be formed of the celerity with which news spreads in Africa, for we are told of Karfa Taura, the hospitable friend of Park in his first mission, performing a six days' journey to meet him on his second expedition, "having just heard that a coffle of white men was travelling the country."

Every requisite provision having been thus previously made, the traveller may set out with some reasonable hopes of success. But, above all things, he should be prepared for spending a considerable time on the journey. He is not to traverse the country as if he were running a race against time, or against the elements. If the unhealthy season overtake him, he is to remain where he is, and not to attempt to vanquish physical impossibilities. He is occasionally to take up his abode with the natives, when illness, or the necessity of removing suspicion from their minds (as happened to Isaaco) shall render it prudent.

The proposal of Park's Editor of employing Mahometan travellers to explore Africa seems to be very unfeasible. They have none even of the elementary points of science; a long time would be necessary for their instruction, and consequently the expense would be great; nor could the same dependance be placed on their narratives which those of Europeans claim. Besides, we are already in possession of all the information which Mahometans can give us, and still it is considered unsatisfactory.

Travellers have on different occasions derived advantage from appearing in the character of physicians. Bruce studied physic for the express purpose, with Mr. Ball, surgeon to the consulship at Algiers, and with Dr. Patrick Russell at Aleppo, and found it of the greatest service. Sonnini, who was a captain in the French navy, and knew nothing of medicine, gave himself out for a physician, with the greatest advantage to his pursuits. Park already possessed this qualification, and found it serviceable. It is therefore advisable that those who may be fixed upon in future should make themselves acquainted with some of the principles of this science.

And this naturally suggests the propriety of making our military stations on the African coast in some measure subservient to the purpose of exploring the interior of that vast continent. The surgeons and assistant surgeons of corps in our garrisons there should seem to be the fittest for this destination, and they should be selected with this view. The situation presents every facility and ample leisure for perfecting themselves in all the preparatory steps.

But it is sufficiently evident that some considerable inducement should be held out to invite men to the enterprise. It is not the temptation of a small piece of money that ought to be considered sufficient; but such a sum as should, if the adventurous individual be successful, constitute a comfortable provision for his after life, or for that of his family should he perish.

Newcastle-upon-Tyne, June, 1817.

HENRY EDMONSTON.

ARTICLE VI.

Extraordinary Case of a Blind Young Woman who can read by the Points of her Fingers. By the Rev. T. Glover.

(To Dr. Thomson.)

SIR,

BEING lately on a visit at Liverpool, I had a favourable opportunity of witnessing the exercise of an extraordinary faculty possessed by a blind young woman, named Margaret M'Evoy; and I have been induced, by the request of my friends, to send the result of my experiments for insertion in your journal.

Without pretending to give a medical report of this singular case, which an abler pen is preparing for the public, I shall briefly premise that Miss M'Evoy is a native of Liverpool, and about 17 years of age. She became blind in the month of June, 1816, from a disorder in the head, which was supposed to be water on the brain, and which was treated as such: she was partially relieved by a discharge from the ears and nostrils. She has since experienced two returns of the same disease, and each time has been relieved by a similar discharge of fluid. A portion of this fluid has, I believe, been analyzed by Dr. Bostock. She has remained completely blind from the time of the first attack. She first discovered by accident, about the middle of October, 1816, that she could read by touching the letters of a book.

Having blindfolded her in such a manner that I was certain not a ray of light could penetrate to her eyes, I made the following experiments, most of which had not been tried before. I copy the results from notes taken on the spot, and nearly in the order in which they were made:—

EXPER. I.—I presented to her six differently coloured wafers fastened between two plates of common window glass. She accurately named the colour of each. She pointed out, unasked, the cracks and openings in the wafers. Being asked, while touching the surface of the glass above the red wafer, if the substance under might not be a piece of red cloth or paper, she answered, “No, I think it is a wafer.”

EXPER. II.—She described the colour and shape of triangular, square, and semicircular wafers, fastened in like manner between two plates of glass.

EXPER. III.—To the seven prismatic colours, painted on a card, she gave the following names: scarlet, buff, yellow, green, light blue, dark blue or purple, lilac. As the orange paint was much faded, the term buff was correctly applied to it.

EXPER. IV.—The solar spectrum being thrown by a prism, first on the back, and then on the palm, of her hand, she distinctly described the different colours, and the positions which they occupied, on her hands and fingers. She marked the moments when the colours became faint, and again vivid, by the occasional passage of a cloud. On one occasion she observed that there was something black upon her hand; but perceiving it to move, she said it was the shadow of her own fingers, which was correct. The prismatic colours have afforded her the greatest pleasure which she has experienced since her blindness; the violet rays were the least pleasant. She never saw a prism in her life.

EXPER. V.—The prism being put into her hands, she declared it was white glass; but, on turning it, she immediately said, “No, it is not; it is coloured; it has colours in it:” and she traced with her finger what she called “bent stripes of colours.” She could discover no colours on that side of the prism on which the direct rays of light fell.

EXPER. VI.—She perceived the coloured rings formed by pressing together two polished plates of glass. She said she felt them at the edge of her fingers flying before them.

EXPER. VII.—Several attempts were made to ascertain whether she could discover colours in the dark, by presenting differently coloured objects to her hands, concealed under a pillow. She always failed; every thing appeared black. On one occasion she said a green card was yellow.

EXPER. VIII.—She read a line or two of small print by feeling the letters. She next read through a convex lens at the distance of nine inches from the book. The principal focal length of the lens is 14 inches. While reading, she gently rubs the upper surface of the lens with the tips of her fingers; she reads much easier through the lens than without it; she says the letters appear larger, and as if they were printed on the glass. A penknife was laid on the line which she was reading, and she immediately perceived and named it.

EXPER. IX.—A concave lens being put into her hands, she tried to read through it at the distance of seven or eight inches, but said that the letters were all confused. As she moved the lens gradually towards the book, she at length perceived the letters, but observed that they were very small. She could not read easily until the glass was laid on the paper.

EXPER. X.—She read common print by feeling on the upper surface of a piece of common window glass held 12 inches from the

book. At a greater distance she could not read; but could read much easier when the glass was brought nearer to the book. In like manner she perceived through the glass several coins spread out before her; told which had the head, which the reverse upwards; pointed out the position of the arms, crown, &c.; read the dates; and observed, unasked, that one half-guinea was crooked.

EXPER. XI.—On applying her fingers to the window, she perceived two newly cut stones, of a yellow colour, lying one on the other, at the distance of 12 yards. She described a workman in the street, two children accidentally passing by, a cart loaded with barrels of American flour, another with loaves of sugar, a third empty, a girl with a small child in her arms, &c. One of the company being sent to place himself in different positions, she marked every change of position as soon as any one with his eyesight could have done. A middle-sized man at the distance of 12 yards did not appear, she said, above two feet high. As he approached nearer, she observed that she felt him grow bigger. All objects appear to her as if painted on the glass.

EXPER. XII.—A stone ornament in the shape of an orange she took for a real orange, feeling through the plane glass, at the distance of two or three inches; at the distance of 15 inches, it appeared no larger than a nut; at 30 inches distance, it was diminished to the size of a pea, the brightness of the colour remaining undiminished.

EXPER. XIII.—On touching a plane glass mirror, she said that she felt the picture of her own fingers, and nothing else.

EXPER. XIV.—Holding a plate of plane glass three or four inches before the mirror, she was then enabled to perceive the reflected image of herself. When the mirror was gradually removed further off, she said her face diminished. All objects constantly appear as a picture on the glass, which she touches.

EXPER. XV.—She perceived through a plane glass, as before, the image of the sun reflected from a plane mirror; also the sun itself. She said that she was not dazzled with it, but found it very pleasant.

EXPER. XVI.—She accurately described the features of two persons, whom she had never seen before, holding the plane glass at the distance of three or four inches from the face.

EXPER. XVII.—Several small objects were held over her head. She perceived them all through her plane glass. On one occasion she asked, doubtingly, if a three-shilling piece was not a guinea; but raising the glass, and bringing it nearer to the object, she corrected her error.

EXPER. XVIII.—She was unable to distinguish colours by the tongue; but holding between her lips the red, yellow, blue, and white petals of different flowers, she told the colour of each accurately.

EXPER. XIX.—She accurately distinguished polished glass from natural crystals by the touch. She declared three several trinkets

to be glass, which were believed to be stone : being tried by a file afterwards, they proved to be paste. She also distinguished between gold, silver, brass, and steel ; likewise between ivory, tortoise-shell, and horn. " Gold and silver," she said, " feel finer than the other metals : crystals feel more solid, more firm, than glass."

EXPER. XX.—She could not discover, by feeling, any difference between pure water and a solution of common salt in water.

These experiments were frequently repeated and varied, during the space of three days that I had the opportunity of seeing her, with the same results.

I must observe that this faculty of distinguishing colours and objects is more perfect at one time than at another : sometimes it suddenly and entirely fails ; then every thing, she says, appears black. This sudden change seems like to what she remembers to have experienced when a candle has been extinguished, leaving her in the dark.

She says that she has not been taught by any one to distinguish colours by her fingers ; but that, when she first perceived colours by this organ, she felt convinced that they were such and such colours, from the resemblance of the sensations to those which she had formerly experienced by means of the eye.

From the preceding facts, it appears evident that Miss M'Evoy has perceptions, through the medium of her fingers, similar to those which are usually acquired through the medium of the eye. With respect to the manner how she acquires them, and the necessity of an intermediate transparent substance when she does not actually touch the object, I shall offer no conjecture.

I have only further to add, that she has no apparent motive for attempting to impose upon those who visit her, were such an imposition practicable. She receives no remuneration from visitors. On the contrary, the mere presence of a stranger agitates her considerably for a time ; so very weak and delicate is her state of health. Any noise or bustle affects her still more painfully : and I am ashamed to say that some of her visitors have showed a great and culpable disregard for her feelings, and subjected her to much unnecessary inconvenience.

I remain, Sir, &c.

T. GLOVER.

Stonhurst, Aug. 25, 1817.

ARTICLE VII.

Proceedings of Philosophical Societies.

ROYAL ACADEMY OF SCIENCES.

Analysis of the Labours of the Royal Academy of Sciences of the Institute of France during the Year 1816.

PHYSICAL PART.—By M. le Chevalier Cuvier, Perpetual Secretary.

ZOOLOGY, ANATOMY, AND ANIMAL PHYSIOLOGY.

(Continued from p. 226.)

M. Cuvier has terminated the work on which he has been so long employed on the anatomy of the molusca by a long memoir on the *poulpe*, the *seiche*, and the *calmar*. The genera which we have just named are the most remarkable of that numerous class of animals, by the complication and the singularity of their structure. Provided with three hearts, with a very extensive nervous system, with large eyes as well organized as those of any animal with vertebræ, with very singular excretory viscera, formed upon a plan of which nature affords no other example. They deserve well the attention of naturalists.

The author has added this memoir to all those which he had previously read to the Institute on animals of the same class, in order to form a quarto volume, with 36 copper plates, which has just appeared under the title of Memoirs to serve as a History of the Anatomy of Mollusca.

While making these anatomical researches on the *seiches*, M. Cuvier had an opportunity of ascertaining the nature of a fossil pretty common in our calcareous beds, and which had hitherto presented an inexplicable enigma to geologists. It consists of a bony substance, concave on one side, with a radiated edge, convex on the opposite side, and furnished with a long spine between the convexity and the edge. It is now demonstrated that this is the lower extremity of a bone of a *seiche*. It is astonishing that so evident a resemblance was not sooner recognized.

The fresh water in some parts of the south of France breeds a very small shell similar to a shield, terminated by a pointed and recurved needle. It had been considered as a univalve, and had been called the *ancyle epine de rose*. But M. Marcel de Serres has just satisfied himself that it is one of the valves of a regular bivalve shell, the hinge of which possesses peculiar characters. He has therefore formed a genus of it, which he calls *acanthis*. The animal of this shell has not hitherto been observed.

Animals without vertebræ in general, considered with regard to

their classification, and the enumeration of their species, form the object of a great work, of which Lamark has just published the first three volumes in octavo, beginning with microscopic animals. The author then proceeds to the polypi, whether at liberty, or supported by the masses more or less solid, to which the name of *corals* has been given. He then comes to the *radiated* animals, a class under which he comprehends the soft beings commonly called *sea nettles*, and those to which their envelope, often spiny, has given the name of *echinodermes*.

He makes a fourth class, which he calls *tunicies*, of those compound mollusca, of which M. Savigny has made us about a year ago acquainted with the singular history; and likewise of the simple mollusca analogous to those the re-union of which forms them.

The fifth class comprehends the intestinal worms, to which the author joins some fresh water worms, which ought, it would seem, to have remained among the annelides.

His third volume terminates with a portion of the insects.

The great details into which M. Lamark has entered, and the new species of which he gives a description, render his book precious to naturalists, and ought to cause the prompt continuation of it very desirable, especially from our knowledge of the means which that skilful professor possesses of carrying to a high degree of perfection the enumeration which he will give us of shells, that immense department of natural history.

As to the history of corals, it has just been enriched by the great work of M. Lamouroux, on those genera whose solid parts are flexible—a work which we have announced several times in our preceding analyses, and which has appeared this year in an octavo volume with 18 plates. A prodigious number of genera and species are recognized, several of which under other names are the same as those established by M. Lamark.

The public possess likewise now the history of the crustaceous animals of Nice by M. Risso, and the fine investigations of M. Savigny on the mouth of insects, and on compound mollusca. These last researches especially, which open to science views entirely new, are well worthy the attention of naturalists. But as both had been previously communicated to the Academy, and as we have already given the analysis of them, we shall dispense with resuming the subject again.

This continued multiplication of animated beings which naturalists observe, the necessity of giving them from time to time a convenient arrangement, and of accurately characterizing them, has determined M. Cuvier to exhibit a collected view of them in four octavo volumes, with 18 plates, which he has just published under the title of the Animal Kingdom arranged according to its Organization.

His object, at the same time, is to make this work serve as an introduction to the great Comparative Anatomy, which he is preparing; and in that point of view he has given equally the internal

and external characters. His classes are those of which we gave a table two years ago; but what we could not mention then, and still can only mention in a general way, is the extreme division of the genera into subgenera, and other lower subdivisions; by means of which the author conceives he has obtained so much precision, that it is scarcely possible to hesitate any longer about the position of a species. This was chiefly necessary when treating of the animals with vertebræ, and has been executed by the author with great care. New observations have been made on the confusions of synonymes, and upon the double application of words, so common with those authors who have not employed extreme critical attention.

M. de Barbançois, corresponding member, proposes likewise some changes, or rather some further subdivisions, in the methodical distribution of animals. He does not think it proper that man should remain confounded with the mammiferous animals, and is even of opinion that a fourth kingdom of nature might be constituted on purpose for him, under the name of the moral kingdom. He conceives that viscous reptiles, or *batricians*, ought to constitute a distinct class from scaly reptiles; that the cephalodes should be separated from the other mollusca; that the cirrhipedal mollusca should be placed at the head of the annelides; and that some other analogous changes should be introduced into the old classes, which he in other respects adopts.

The great object of this kind of research is less to establish or multiply subdivisions than never to omit classing in those which are admitted animals which resemble each other, nor to place together animals which do not resemble each other. In this point of view M. de Barbançois does not contest any of the relations recognized by the naturalists who have preceded him.

One of the most interesting questions in physiology is the origin of the azote which constitutes an essential element of the human body. It was suspected that respiration, which carries off the carbon and hydrogen from the blood, and leaves the azote, contributes in that way to increase the relative proportion of that substance. But it was not positively known whether this azote came entirely from the food, or whether the atmosphere likewise furnished a part, either by means of respiration or by absorption, over the whole surface of the body, or whether it was not produced by the action of life itself.

M. Magendie wished to determine the point by experiment; and for that purpose he fed animals with substances that contain no sensible quantity of azote; namely, sugar, gum, olive oil, and butter, to which he added distilled water. These animals all died; but with very singular phenomena, particularly with an ulcer in the cornea, which sometimes pierced that membrane so that the humours of the eye were emptied. Their secretions assumed the characters of those of herbivorous animals. The principles containing azote gradually diminished in them; the volume of the *muscles* was reduced to one-sixth; and these consequences did not

proceed from want of digestion; for food destitute of azote furnishes chyle, and fills the lacteals, and sustains life a much longer time than if the animal were entirely deprived of nourishment.

Azote is an essential constituent of urea and uric acid. These elements of the urinary calculus diminish sensibly in the urine of animals fed upon food destitute of azote. M. Magendie concludes from this that by means of a vegetable diet the progress of the dreadful disease of the stone might be at least retarded. It is true that a regimen entirely vegetable sometimes occasions a disease of an opposite kind; namely, diabetes, or an excessive flow of urine, containing a saccharine matter, a disease cured by feeding the patient on animal food.

These facts may become useful in medicine, and furnish important dietetic indications.

M. Magendie has likewise, in conjunction with M. Chevreul, made experiments to determine the nature of the gases which are evolved during digestion in different parts of the alimentary canal. In four felons, who had taken a little before their death a determinate quantity of food, the stomach contained oxygen, carbonic acid, hydrogen, and azote. The small intestines contained the last three gases; but no oxygen; and the large intestines, besides carbonic acid and azote, contained likewise carbureted and sulphureted hydrogen. These last two, therefore, belong only to the large intestines. The oxygen is found in the stomach only. The azote and carbonic acid exist in the whole canal, and the quantity of the latter increases as we proceed downwards.

MEDICINE AND SURGERY.

If ignorance is often dangerous in medicine, it is perhaps never more terrible than in those cases, when, called to the support of justice, it misleads by incautious analogies, which may draw upon innocence the disgrace and the punishment due to crimes. The work, therefore, which M. Chaussier has undertaken on medical jurisprudence, and which is intended to unite the information derived from anatomy, chemistry, and physiology, in order to determine the cause of death from an inspection of the dead body, is of the greatest importance to society. To the general rules which he prescribes, he adds, by way of example, several reports made to courts of justice relative to remarkable cases, and joins his remarks upon the omissions, errors, and obscurities, and the false reasoning, which too frequently occur in these important pieces.

All this part corresponds perfectly to the epigraph of the book:—

Sontibus iade tremor; civibus inde salus.

But the author has not confined himself to what his title promises. He has pointed out, likewise, the mistakes in the ordinary way of opening dead bodies for the purposes of pathological anatomy—mistakes which have often lead to false conclusions respecting the nature and seat of maladies. Physiology itself will profit by a great

number of delicate remarks on functions little studied, which this skillful physiologist communicates by the bye.

M. Moreau de Jonnés, who observed with so much care the geology of the Antilles, has not employed himself less zealously in investigating their climate, its fatal effects on the health of Europeans, and the means of preventing or curing a part of the evils which it occasions. In particular he has examined by what rules of regimen it would be possible to preserve the troops there. The precautions which he points out for the disembarkation, lodgment, food, and marching of the soldiers, are dictated by a wise medical theory; and most of them have been already confirmed by experience. His work has been sent into the colonies by order of the Ministers of War and of the Marine.

M. Boyer has given a valuable memoir on a cruel disease of which he first found out the method of cure. It consists in certain fissures which occur at the anus, and which, being accompanied by a spasmodic state of that part, occasion dreadful pains and insupportable anguish. An incision of the sphincter, made carefully, always makes them cease in a short time.

M. Larrey is one of those surgeons who have exercised their art on the vastest and most varied theatre. Attached to the French armies during 25 campaigns, he has followed them through the four quarters of the world, and directed as chief the surgical service in Egypt and in Russia, as well as in all the intermediate climates; during epochs of the most brilliant victories and the greatest prosperity, as well as of defeats the most frightful, and the most complete final reverses. Every kind of experience, therefore, came in his way, and he took advantage of them all.

To the results of his experience already consigned in his books, he has this year added important observations on the effects of foreign bodies introduced into the thorax, and on the operations undertaken to extract them. When collections of pus and blood have forced the lungs to contract, the extraction of these matters occasions in the thorax a vacuum, which nature endeavours to fill up either by the production of a new substance, or by displacing the ribs and some other of the neighbouring parts. M. Larrey has shown these changes in individuals whom it was in his power to open, because, after their cure, they fell victims to other accidents.

He has given an example of a person perfectly cured of the extirpation of the superior articulation of the thigh bone, an operation respecting the possibility of which M. Larrey first fixed the opinion of practitioners, by making known the method by means of which it may be performed with certainty.

RURAL ECONOMY AND TECHNOLOGY.

The hair of the castor, so necessary in the fabrication of fine hats, becoming more and more scarce and dear, several other kinds of hair have been tried, without finding any that can be entirely substituted for it. M. Guichardier, hat-maker in Paris, has just

employed successfully the hair of the sea otter and the common otter. It is true that hats made entirely in this way would be a great deal too dear; but we may with profit sprinkle, or, as the hatters say, *gild* with this hair hats the body of which is composed of a more common stuff. This has been long done with the hair of the castor.

We ought likewise to place in the rank of useful works which have occupied the members or correspondents of the Academy during the year 1816, the instructions of M. Huzard on the measures to be taken by feeders in order to disinfect their stables, and preserve their cattle from the epizootie; several articles of agriculture inserted by M. Yvart in the New Dictionary of Natural History; and especially the article on the copulation of domestic animals, which was read to the company; and the history of French agriculture, by M. Rougier de la Bergerie.

MATHEMATICAL PART.—By *M. le Chevalier Delambre*,
Perpetual Secretary.

Never perhaps was the zeal of mathematicians better supported. Never perhaps have they devoted themselves with more constancy to their accustomed labours, to the development of their first ideas, to the completion of works already published in part, and yet we have never experienced so many difficulties in drawing up the annual history of the Academy. Reduced almost to our bare recollections of memoirs, which the authors have withdrawn in order to revise or extend them, or which they have already sent to the press, in order to accelerate by every means in their power the publication of the volume, which will be the commencement of a new series, under the title of New Memoirs of the Royal Academy of Sciences, we can only briefly point out the different objects which have occupied our meetings during the year which has just elapsed. Besides, the more progress that mathematics have made, the more difficulty will there be to make them advance further, and the more impossible it will be to render striking the new results obtained. The problems become complicated; even the annunciations of theorems require continued attention, in order to understand their meaning; the applications of analysis to physics, which, after the complete explanation of the system of the world, constituted the hopes of mathematicians, has hitherto offered only problems surrounded with difficulties. Even the experiments are far from being as simple as those which made us acquainted with the nature and principal phenomena of light and electricity. It is requisite to repeat them, and to study the necessary apparatus, in order to form an idea of the new truths which are the fruit of these researches; and this requires an equal degree of patience and sagacity. Hence, though to philosophers by profession the quantity of labour be always the same, yet the portion of which we are able to give an account must diminish every day.

Our readers, then, will not be much surprised if we confine our-

selves merely to the titles of several memoirs, notwithstanding the importance of the subjects, and the merits of the execution. Among these are—

1. A long memoir of M. Poisson, on the *Variation of arbitrary constant Quantities*.

2. *The Formulas of M. Cauchy relative to the Determination of Definite Integrals, and the Conversion of Finite Differences of Powers into Integrals of the same Species*; and his demonstration of a curious theorem relative to numbers, in which he draws as a simple corollary a remarkable property of common fractions observed by Mr. Farey. Likewise a memoir on particular solutions; and another on the imaginary roots of equations.

3. Two long memoirs, with notes, on diffraction, by MM. Pouillet, and Biot who has inserted them in his *Traité de Physique*, to which we will devote a particular article.

4. Different memoirs of M. Biot on the *Sound of the Strings (Anches) in Musical Instruments*, on the *Intonation of the Pipes of an Organ filled with different Gases*, on the *Pile* and on *Electricity*, the description of a *Colorigraph*, and his *New Experiments on the Polarization of Light*.

(It is known that M. Arago is employed in researches relative to this last object, with which he has repeatedly occupied the attention of the Academy, and which he proposes to unite in a particular work as soon as he has completed them.)

5. Lastly, the notices read by Count Laplace on the *Velocity of Sound in different Substances*, on the *reciprocal Action of Pendulums*, and on a *Precaution hitherto neglected in the Experiments which serve for the Determination of the Length of the simple Pendulum*.

Of all the experiments of this kind tried at different times by the most distinguished mathematicians, astronomers, and philosophers, those of Borda are generally considered as the most certain and conclusive, both on account of the attention bestowed, the ingenious processes followed, the size of the apparatus, and the well-known skill of this excellent observer.

It is admitted that he very properly preferred the suspension on a thin edge, which he considered as more susceptible of precision than suspension from pincers; because in these last there is always some uncertainty with respect to the true point round which the oscillations are made; while in the other, the edge of suspension being very fine, the centre of motion may be conceived to be on the plane itself on which it rests. This supposition, which Borda adopted, and which was long granted without any hesitation, at length gave rise to some doubts. It has been thought that the edge could never be sufficiently sharpened to be considered as a mathematical line. That it ought rather to be considered as a small cylinder, the centre of which was more elevated than the line of contact; so that the radius of this cylinder would require to be added to the length measured. The question deserved to be examined; and if we

could not flatter ourselves with being able to determine the radius of this cylinder, and the correction which it would require, the amount at least might be estimated, and the limits of the error known. M. Laplace has just submitted this question to calculation, and the result no doubt surprized himself; as he found that this radius, whatever it be, must be subtracted from, and not added to, the length measured. But this length is about four times that of the pendulum. This is sufficient perhaps to legitimate the supposition of Borda; but it is at the same time a piece of knowledge useful to those philosophers who propose to repeat the experiment with much shorter pendulums.

Besides these different notices, all of them happy applications of the general principles which he has established in his *Mecanique Celeste*, M. Laplace has given supplements and useful additions to his *Analytical Theory of Probabilities*, and to the *Philosophical Essay on the same subject*, the third edition of which appeared a few months ago.

The author terminates that work with this reflection, *that there is no science more worthy of our meditations, and that it would be useful to make it a part of the system of public instruction*. This philosophical view has been seized by M. Lacroix, who perhaps might have found it in the writings of a celebrated mathematician, who has repeatedly exercised himself on that difficult subject, and it has given birth to the following work, which will complete the mathematical course of this author.

Traité élémentaire du Calcul des Probabilités, par S. F. Lacroix. Paris, Madame Veuve Courcier, 1816. When genius has created a new science, or when by a skilful analysis it has extended the limits of science, it is the duty of every one employed in the public instruction, and to whom all parts of modern geometry are equally familiar, to read and comment on original works, to extract from them every thing that can be rendered intelligible to ordinary readers, to seek for direct and particular demonstrations of the most useful theorems, which the inventor has found by methods more general and rich, but more difficult to comprehend. This is the case with the new work of M. Lacroix, who has given the subject all the interest of which it is susceptible, by well-chosen examples, by numerous quotations from original writers, by his care in assigning to each the part which he can legitimately claim, and by a detailed history of the labours of this kind performed by the greatest of mathematicians, from the age of Pascal and Fermat, to our own times.

From the time of the suppression of the Academy of Sciences, which is nearly when Legendre published his first memoir on Elliptical Transcendentals, this profound mathematician has not ceased every year to extend this theory, which he had in some measure created, and which he has explained in his *Exercices on the Integral Calculus*, to which he has already published several supplements.

The last of these, which appeared in July, 1816, has for its object the construction of elliptical tables.

In pointing out to mathematicians all the advantage which they might draw from transcendentals of this species, the author had announced that his solutions would not become truly useful but by means of tables in which these fractions could be valued in all cases to a convenient degree of approximation, and without requiring too fatiguing calculations—tables which should do for analysis nearly the same thing as tables of the sines, and tangents, and the logarithms of numbers, do for astronomy. The construction of these tables constitutes the principal object of the new supplement of Legendre.

The first of these tables gives 900 values of the quadrants of the ellipse, and an equal number of values of the analogous function F' , 420 of which at least have been calculated directly as far as 14 places of decimals; the remainder have been calculated as far as 12 places. These transcendentals, then, are now known more exactly than the circumference of the circle was before the calculations of Ludolph Van Ceulen. To this have been joined the first, second, and third differences, and the whole has been reduced to 12 decimals. As far as 70° of the *argument*, the third differences, which at first contained only a single significant figure, has increased progressively, so as to become 6778 for E' and 25284 for the function F' . It was then necessary to add the fourth differences, which are then 49 and 362, and increase afterwards to 485160 and 5706908015, which are the last numbers of these two columns.

The second table gives the values of the functions E calculated to 12 decimals for all the amplitudes φ from half degree to half degree from 0° to 90° , the angle of the modulus being 45° . This table is likewise terminated by the 12th decimal, and it gives the first, second, third, fourth, and fifth differences.

The third table contains the natural sines to 15 decimal places, and their logarithms to 14, for all the arcs of 15 minutes. It is extracted from the great tables of Briggs.

The fourth table gives the logarithmic values of the tangent ($45^\circ \pm \varphi$) for all angles from $30'$ to $30'$ between 0° and 90° to 12 decimal places, with five orders of differences.

At the end of this table we find nine corrections for the logarithms to 20 decimals, from the edition given at Avignon by Pezenas; on which we will remark that, of these nine logarithms, two only are found in the English edition of Gardiner, and that they are correct. They all occur, and are equally correct, in the stereotype edition of Collet.

Finally, to extend the use of this table of logarithms to 20 decimals, M. Legendre has extracted from the great tables of Cadastre (deposited with the Board of Longitude, and of which a notice is given in the Memoirs of the Institute, vol. v.), the logarithms to

19 decimals of all the odd numbers from 1163 to 1501, and of all prime numbers from 1501 to 10000.

It is impossible to give an idea here of the means employed by the author either for the construction, verification, or interpolation, of his tables, if it be wished to render them more extensive. It will be sufficient to say that nothing has been spared to facilitate the labour of those who choose to construct a complete system of elliptic tables. The author "hopes that this enterprize, the utility of which will be perceived more and more, will be one day executed by some of those laborious men who appear from time to time in the career of science to leave durable monuments of their patience and their zeal."

On account of these new tables, the author has made researches to facilitate the interpolation of the great trigonometrical tables, such as those of Briggs, Reticus, and Vlacq. He published them in the *Connaissance des Temps* for 1819. By the methods which he points out, we may find to 14 decimals the sine, cosine, and tangent, of every arc, or the arc which corresponds to any given trigonometrical line whatever.

In the most ordinary cases, when so great a number of decimals are not necessary, the formulas become simple, and may be useful and commodious in trigonometrical calculations which require particular attention.

At the end of this memoir we find a very elegant formula for calculating the latitude of a planet in seconds, and in the function of the tangent of the demi-inclination. The author deduces it from a more general formula, demonstrated in the 116th article of the fifth part of his *Exercises of the Integral Calculus*. It may be deduced still more simply from the series which Lagrange has given for the angle which the ecliptic makes at any point with the parallel to the equator. This series may be transported to the declination of the sun, as we have remarked. (*Astronomie*, ii. 239.) In this case, to have the declination of the sun in a function of the right ascension A , it is sufficient to put $(90^\circ - A)$ in place of the longitude L of the formula of Lagrange, and we have for the declination D the formula

$$D = 2 \operatorname{tang.} \frac{1}{2} w \sin. A + \frac{2}{3} \operatorname{tang.}^3 \frac{1}{2} w \sin. 3 A + \frac{2}{5} \operatorname{tang.}^5 \frac{1}{2} w \sin. 5 A + \&c.$$

We have even calculated, in the place quoted, the numerical coefficients of the first terms, the fifth of which may be always neglected. The only inconvenience of that formula is, that it gives the declination in a function of the right ascension, or the latitude in a function of the argument reduced to the ecliptic, whereas we generally want them in a function of the longitude, or of the argument not reduced from the latitude. This made us seek for a series which has not this inconvenience. We found one still more converging, but the coefficients have not the same simplicity.

M. Legendre has likewise published a supplement to his Theory of Numbers, second edition, February, 1816.

This supplement is divided into three chapters. The first shows the means of dividing a given number into four squares, such that the sum of their roots is equal to a number given comprehended between certain limits.

This problem serves as an introduction to the next chapter, the object of which is a general demonstration of the theorem of Fermat respecting polygonal numbers. This demonstration is founded on the same principles as the one recently discovered by M. Cauchy. But it differs from it in some respects, and it supposes nothing demonstrated but the theorem relative to triangular numbers, which is the first case of the general theorem.

In giving an account last year of the discovery made by M. Cauchy of a demonstration hitherto sought in vain by all mathematicians, we expressed some doubts respecting the reality or the generality of the demonstration which Fermat had announced in the most positive terms, which he had never given, and no vestige of which could be found among his papers, although from its nature that demonstration must have been long. It appeared, therefore, unlikely that Fermat should have written nothing on a subject which required so much developement; and we had suspected that Fermat, after having more carefully examined his demonstration, had been himself dissatisfied with it, and had resolved to suppress it entirely.

M. Legendre, on the contrary, has no doubt that Fermat was in possession of the general demonstration of his theorem. He thinks merely that Fermat's demonstration was quite different from the one which he himself has given. Fermat knew only two cases at most of the trinary form of numbers, without which he would not have restrained to the form $(8n - 1)$, a property which extends generally to all odd numbers. In fine, Fermat did not *perceive a thing which gives more precision and elegance to his theorem, namely, that in the $(m + 2)$ polygons of the order $(m + 2)$ which compose a given number, there are always $(m - 2)$, which may be supposed equal to 0, or unity.* This condition, added by M. Cauchy, will show that Fermat himself had not a very precise idea of his theorem. But M. Legendre goes still further; he demonstrates *that beyond a certain limit easily assigned for each order of polygons, every given number may be decomposed into four polygons, or five at most.*

These two limitations, added to the theorem of Fermat, appear to us sufficiently important to enable us to say that, after it is demonstrated this theorem is not quite the same, and that without ceasing from being true, according to the more general enunciation of the author, it has received two modifications useful to be known. The third chapter of this supplement contains new methods for approximate solutions of numerical equations.

One of these methods requires merely that we should know a

superior limit to the greatest of the roots, and this limit is found by a very simple formula.

The author gives the name of *omale*, that is, *without irregularity*, to every function of x which possesses the property of being always increasing or decreasing in proportion as x augments in a positive sense from x equal to zero to x infinite.

He determines, then, the greatest of the roots, and, dividing the equation by that root, he reduces it one degree, and seeks again the greatest root of the equation thus prepared. Here the limit is known, since the second root is necessarily less than the first. The same process will give successively all the roots in the order of the greatness, all decreasing.

The second method consists in dividing the proposed equation into two simple *omale* functions. The curves of these two equations are constructed, and the different intersections of these curves, give us the positive roots which can be determined.

The author, finally, employs himself in the more difficult investigation of imaginary roots; but it is obvious that this last part must be much less susceptible of extract than the former.

He concludes by announcing to the lovers of the theory of numbers two important works, and almost indispensable in researches of this nature. The first is the *Cibrum Arithmeticum* of M. Chenac, Professor of Philosophy at Deventer, in which we find all the prime numbers, and all the divisors of the other numbers from one to one million, and further. This work has already proved that the rule of M. Legendre, to find in what quantity prime numbers occur between two given limits, is an uncommonly exact approximation. The other is that of M. Burckhardt, who, in order to extend this table much further, has invented a sure and easy method, which has furnished him in a short time the smallest divisor of any number comprehended between two millions following each other. Before going further, M. Burckhardt thought that he ought to give the first million in the same form as the second and third. This first part has just appeared under the title of

Table of the Divisors of all the Numbers of the First Million, or more exactly from 1 to 1020000, with the Prime Numbers found among them, by J. Ch. Burckhardt. Paris, Madame Veuve Courcier, 1817.

The preface announces the comparison of the million of M. Chernac with a manuscript of M. Schenmark, which the Institute possesses, and gives a table of the typographical errors which this comparison has enabled him to discover in the *cribrum* of M. Chernac. Nobody will be surprized that several typographical errors should have made their way into a work of this kind; and M. Burckhardt himself requests us to state that a fault of this kind has escaped him in p. 2, in the example which he gives of the use of that table. He makes choice of the number 784241, and the object is to find its smallest divisor 53. The number, by mistake, has been printed 764241. But the error is easily observed, and

will deceive nobody; for in p. 88, which is correctly pointed out, it will be perceived at once that the number ought to begin with 78, and not with 76. Besides, all those who have been employed in the disagreeable labour of the publication of tables, whether astronomical or arithmetical, have learned by experience that the mistakes left in them seldom occur in the most difficult places, which have been examined with the most severe attention, but most commonly in those places where they might have been most easily avoided, so that they at once strike the eyes of the reader less engaged with them, even when he does not look for them.

M. Burckhardt then explains the methods which he has contrived to extend the use of these tables of divisors. He finishes by announcing that, if the sale of the first three millions gives any hope of enabling him to publish the following ones, that little labour is wanting to complete the fourth, fifth, and sixth millions.

Let us point out to calculators another typographical error. It occurs in those tables which it is customary to employ with confidence—those of Schulze and of Vega. *The hyperbolic logarithm of 1853 is 8.968 instead of 8.967.* The number, we conceive, ought to be 7853, and not 1853. In fact, the logarithm of 7853 begins in both tables with the figures 8.967, and it is evident that the 7 is too small. An easy calculation shows that in reality we ought to read 8.968; a new proof of what we just now said, that errors exist always in those places where they are most easily perceived, and over which the tired eye of the reviser passes in a careless manner.

ARTICLE VIII.

SCIENTIFIC INTELLIGENCE; AND NOTICES OF SUBJECTS CONNECTED WITH SCIENCE.

I. *Curious Effect of Paste on Iron.*

AT Deanston, near the village of Down, in the county of Perth, there is a manufactory where cotton is woven by machinery. Iron cylinders were used in order to apply the weaver's dressing to the cloth. This dressing, as is well known, is nothing but common paste made of wheat flour or barley meal. The cast-iron cylinder was in a short time rendered quite soft, and similar to plumbago, by the action of the paste. This corrosion took place repeatedly; and it was so rapid that the proprietors of the manufactory were obliged to substitute wood in place of the iron. I conceive that the paste employed was usually sour, and that it was the acid developed which, by dissolving the iron, produced this curious effect. A similar effect is produced upon cast-iron by the action of muriate of magnesia, and probably other salts.

II. Further Improvements in the Oxygen and Hydrogen Blow-pipe.

(To Dr. Thomson.)

DEAR SIR,

Since my last, in which I proposed a zigzag pipe, I have been led to consider the best mode of forming Dr. Clarke's sagot of tubes, from the very great difficulty, not to say impossibility, of obtaining any thing similar to his proposition. Both the cane and wire one of Mr. Beale are, I think, objectionable: the cane must be liable to be burned, from the return of the oxy-hydrogen flame: the wire, though ingenious, would, if made of iron, be liable to oxidation; and if of copper, would, I think, be too flexible, and easily put out of order. The one I shall propose will, I think, remedy both these objections, besides giving an advantage that neither Mr. B.'s nor Dr. C.'s can very easily allow of; namely, that of giving passage to any quantity of gas, and thereby being rendered applicable to manufacturing purposes—a desideratum of the highest importance. The form of the tube that I now propose is briefly this:—A number of brass or copper plates laid one on the other, the edges of which are slightly thickened, so as to allow of a very small space between each plate. It is evident that this sort of tube may be extended to any size, without either inconvenience or greater liability to explosion, and that any volume of flame may be used, provided the gazometer be of sufficient capacity. The blow-pipe might by this means be peculiarly adapted to the purposes of smelting ores, a use of the utmost importance, since the saving in fuel would be incredible, from the comparatively light expense attending the production of the gases, particularly where the metal is difficult of reduction. The oxygen might perhaps be obtained from the ores themselves. Instead of condensing the gases into a gazometer, as in the small blow-pipe, they might be driven out of a reservoir into the tubes by means of a double bellows worked by a steam-engine (which would materially lessen the danger of explosion), the superfluous steam of which might be employed to form the hydrogen. In order to render these tubes safer, I should recommend each end being covered with a piece of wire-gauze; and the cap at their end, for gathering together the gases, when used for large purposes, might, to prevent fusion, be made of platinum, without much greater expense. I should also recommend another piece of gauze being placed within the safety cylinder, just above the oil. Should any, or all, of these speculations be in your opinion either idle, or in any other way unworthy of insertion, you will suppress them accordingly.—A (Pl. LXXII. Fig. 4) represents the safety cylinder: B, the tube made of copper plates, the two ends, *a, a*, of which are capped with wire-gauze: C, another piece of gauze extending over the whole surface of the safety cylinder, just above the oil; this might be double: D, a

tube with a stop-cock perforating the gauze, in order to fill the cylinder with greater ease: E, the cap for collecting the gases, which in large works should be made of platinum: F, the tube viewed in front: b, the spaces through which the gas passes.

I am, Sir, your obedient servant,

Worcester Tything, Aug. 8, 1817.

F. G. SPILSBURY.

III. On a Lactometer. By Mr. Johnson, Surgeon, Lancaster.

(To Dr. Thomson.)

SIR,

In Mr. Holt's Agricultural Survey of Lancashire there is delineated a lactometer, constructed by Mr. Dicas, on the principle that if the specific gravity of milk be taken before and after the separation of the cream, the difference will indicate the proportion of cream and the relative value of the milk.

This instrument is expensive, and liable to the objections of uncertainty, because of the saline constituents of milk, and difficulty of application, in consequence of the very slight change produced on the specific gravity of milk by abstracting the cream. The desired results may be obtained more correctly in an easier way.

When new milk has been set aside for a few hours in a cylindrical vessel, the column of cream may be seen floating on the surface of the milk, and, if the vessel be 10 inches deep, and properly graduated, every tenth of an inch on the scale will indicate one per cent. of cream.

Early last year, having again met with the description of Dicas' lactometer in Dr. Dickson's new edition of the Agricultural Survey of this country, I transmitted to the Board of Agriculture a drawing like the annexed (Plate LXXII. Fig. 5), with some such remarks as the foregoing. My paper was ordered to be published in the next volume of Communications, which, I believe, has not yet appeared. About the same time I requested Mr. Newman to make the instrument for sale.

I am informed, by a very respectable Vice-President of the Board of Agriculture, that he caused some of the instruments just described to be fitted up in stands, and sent them to the President of the Royal Society, and other patrons of agricultural inquiry, some of whom described the instrument in the public papers.

Having no interest in the sale of these instruments, I should have waited for the next volume of Communications to the Board of Agriculture, had I not seen a notice on this subject in the last number of the Journal of Science and the Arts.

May I request you to give this paper a place in the *Annals of Philosophy*, and to inform your readers that Mr. Newman constructs these instruments accurately, and at a very moderate price?

I am, Sir, your very obedient servant,

Lancaster, July 10, 1817.

C. JOHNSON.

SIR,

(To Dr. Thomson.)

Lancaster, Aug. 5, 1817.

A few weeks ago I sent you a note on the subject of a lactometer. I have subsequently met with an extract from the Report of a Committee of the Highland Society on the use of aerometric beads; and as some passages in that Report seem to be founded on a cursory estimate of the specific gravity of milk and its constituents, I beg leave to mention a few facts which appear to me at variance with some conclusions of the Committee.

Although the butter is lighter than water, yet cream is specifically heavier; so that no combination of the cream and curd can so counteract each other as to afford rich milk with a low specific gravity; neither will the abstraction of the cream cause any considerable variation in the specific gravity of the remaining skimmed milk. If, for instance, the specific gravity of cream be 1024,* and that of skimmed milk be 1033,† and if good milk contain 15 per cent. of the former, and 85 of the latter, its specific gravity ought to be 1031.5, and the difference between new and skimmed milk only 1.5. Experiment has indeed afforded me a difference somewhat greater, viz. three, four, or five degrees in 1000, but not proportioned to the quantity of butter in any regular manner.

The curd bears a considerable proportion to the entire milk, and is comparatively heavier; ‡ yet when milk is coagulated by rennet, the curd mostly floats in the whey. I found the specific gravity of new milk and its whey to be 1031 and 1030; that of some skimmed milk and its whey 1032 and 1029. Muschenbroeck and Brisson § observed or calculated a much greater difference; but their whey had only a specific gravity of 1016 or 1019, which is much lower than any I ever met with.

In the separation of cream, of butter, and of curd, changes are constantly going on; these as yet are little understood; but the evolution and absorption of gaseous matters have been noticed, and must contribute to render the specific gravity of milk a very uncertain test of its relative value.

I remain, Sir, your obedient servant,

C. JOHNSON.

IV. On a Rain-gauge. By the Same.

Some years ago Mr. C. Seward, of this town, made me a rain-gauge, which I should not have ventured to mention, but that it seems to be an improvement of those described in the *Manchester Memoirs*, vol. iv. ; and in *Nicholson's Encyclopædia*, Article *Rain-gauge*.

It is merely a funnel, the area of which is 100 inches at top, sur-

* Berzelius, *Medico-Chir. Trans.* vol. iii.

† Ibid.

‡ The curd of skimmed milk, dried until it became brittle, had a specific gravity of 1150. The crust of a cheese was about the same. A slice of good cheese was 1063; some inferior cheese was 1087.

§ *Nicholson's Fourcroy*; ix. 497.

mounted with a hoop about $1\frac{1}{4}$ inch deep. The rain collected in this funnel being measured, every cubic inch will indicate $\frac{1}{10}$ of an inch of rain. A funnel 11.3 inches in diameter is very nearly of the proper size.

V. On preparing Extracts, &c. By the Same.

In the preparation of vegetable extracts, in evaporating diabetic urine, &c. the last portion of water is expelled with most difficulty, and the last stage of the process seems most injurious to the product. If small quantities of rectified spirit be added occasionally, this stage is shortened, and less injury is sustained.

VI. Observations on the Nomenclature of Clouds.

(To Dr. Thomson.)

SIR,

The cloud which Mr. Johnson, of Lancaster, has described in your 51st number, p. 216, and which he would term a *lanceolate* cloud, is a thick linear *Cirrus*, which I have seen three times within the last month (June); and when at about 50° or 60° above the horizon, it has gradually changed, by the gentle pressure of an upper current, into a beautiful *Cirrocumulus*: and fine weather for many subsequent days was twice the result. Indeed, I have often remarked that the ramified *Cirrus* is a more certain harbinger of approaching storms of wind and rain than the thick linear *Cirrus*. The other modification, which Mr. J. compares to the shape of a man's hand, is simply the *Cumulus* cloud, raised from the surface of the water in a dense hemispherical body by the heating effects of caloric downwards in its neighbourhood; and the long tufts expanding like fingers often belong to a vapour of the same density, sometimes in the front, and at other times in the rear of that cloud. I have observed that this modification, in whatever shape it may present itself, is generally attended with the most fertilizing weather, it being more frequently seen in the summer than in the winter months, from the abundant evaporation.

Seeing lately an explanation of the nomenclature of clouds, in the first volume of your *Annals of Philosophy*, as used by Luke Howard, Esq. in his remarks on the weather; and also some acute objections by Mr. Johnson on the compound terms of the nomenclature, in the 51st number, p. 217, I beg to suggest the propriety of your obtaining a correct engraving of the various modifications of clouds. The drawing, I think, could be comprised in a 4to size, divided into seven perpendicular parts, and in as many divisions lengthways as the appearances of each modification require, preserving narrow spaces before them for the appellations. The *Cirrus*, or first highest and lightest modification in the atmosphere, agreeably to this plan, would occupy five horizontal divisions of $1\frac{1}{4}$ inch deep, in squares, ellipses, circles, or semicircles, whichever may be found most convenient; namely, the *ramified*, *linear*, *curled*, *lock*, *plumose*, and the *light veil*—the first four to be drawn on an

azure ground, and so on with the rest of the modifications. But if this space should be found too small to draw them in to advantage, the depth might be increased to $2\frac{1}{2}$ inches: in that case the plate would be double, and the impression therefrom would fold twice. The drawing might be prepared by, or under the superintendance of, the projector of the nomenclature, and by him only it could be done in a masterly manner; and a proof impression should be submitted to his inspection, lest any touches be omitted by the engraver. If some such engraving as this were executed for the *Annals of Philosophy*, as a general reference, I am fully persuaded that no future endeavour to extenuate Mr. Howard's merits as a first-rate meteorologist would be attempted; nor would there be any more cavilling on the supposed abstruseness of the nomenclature: for by these means it would soon become more generally known, and more practically useful to the lasting credit of the projector—not that I think he has the least ambition for any superfluous meed on that score.

I am, Sir, yours respectfully,

GLOSTERIAN.

VII. *On the Hedgehog.*

(To Dr. Thomson.)

SIR,

The strong prejudices which are in many parts of this kingdom entertained against that harmless animal the hedgehog, or urchin, and the erroneous information respecting it which has in some particulars been given by naturalists, induce me to offer you the following observations, which are the result of near two years' acquaintance with its habits.

The hedgehog subsists entirely on snails, slugs, worms, millipedes, and other insects, and is consequently the best assistant the horticulturist can have in clearing his plants from those destructive vermin. It never eats fruit, as it has been asserted by most zoologists that it does; nor, as far as I have been able to ascertain, does it make roots or any vegetable substance a part of its food. It is too gentle and timid to attack young hares, partridges, or pheasants, as the ignorant gamekeeper will assert, to justify his persecution of a defenceless animal: and the vulgar idea that it will suck a cow is too absurd to require refutation. If put into a garden, it will in the course of two or three nights entirely clear it of slugs; but of course it can only be confined within a walled one, and it will be necessary to feed it after the first few days, as it will not find a sufficient supply of insects for its support. For this purpose a little raw meat, or entrails, should be placed near its nest every other night; and it will also require a little water in a shallow pan. It will secrete itself by day in the most retired spot it can find, making its nest partly in the ground, and covering it over with leaves. If disturbed, it generally forsakes the place; and forms another habitation, whence it rarely stirs but in the night. As far as I can judge,

the confinement of even a tolerably sized garden does not agree with the constitution of the hedgehog, as I have generally found it prove fatal to him in the course of five or six months. It would consequently be advisable to keep him only for a limited time, then restore him to liberty, and have his place supplied by a fresh one. In winter he remains in a torpid state, seldom coming from his nest unless the weather is very mild. It is, therefore, of little use to detain him from his wild haunts, except in spring and summer.

Should you think the above worthy a place in the *Annals of Philosophy*, you may perhaps rescue a few of the harmless hedgehog tribe from persecution and torture.

I am, Sir, your humble servant,

E. B. C. G.

VIII. Prizes of the Royal Academy of Sciences and Belles Lettres of Brussels for the Year 1818.

The Royal Academy of Sciences and Belles Lettres had proposed on June 18, 1793, for the prize question for 1794, the following problem:—

What Places in the 17 Provinces of the Netherlands, and in the Country of Liege, could be considered as Cities between the seventh and the twelfth Century exclusively?

Two Latin memoirs had been sent on this question: but when the French armies entered in the year 1794, the Academy, being obliged to separate, was unable to decide upon their merits, or award the prize. Being re-established by the care and munificence of the King, it made a point of again proposing the same question, in hopes of receiving answers still more satisfactory; permitting at the same time the memoirs already sent to come in competition with those that were expected.

A single memoir, written in French, has been received since that period, with the following inscription:—

Centum habitant urbes magnas uberrima regna.—VING. ÆN. I. 3.

But this memoir, far from surpassing those already sent, is much inferior to them; the author having seldom consulted contemporary authors and original sources of information. He has shown but little critical sagacity in discussing facts, and has drawn most of his proofs from modern books, by means of which he has frequently been misled.

The Academy was obliged, in consequence, to return to the old memoirs, and the gold medal was voted to the Latin memoir with the following motto:—

Quot post excidium Trojæ sunt eruta castra?

This memoir, though it has not answered all the objects of the Academy, exhibits much discernment, considerable critical sagacity, and an intimate acquaintance with the history of the provinces.

An *accessit* has been given to the memoir with the inscription—

Quot pagos olim, claras nunc cernimus urbes.

The letters containing the names, which had accompanied these two memoirs, not having been found, the authors are requested to make themselves known, by sending to the Secretary the requisite information.

The Academy has received no memoir on the state of the sciences and literature in the Low Countries during the few last years. It has resolved, in consequence, to propose again this question for the year 1818, in the following terms:—

To trace a historical Picture of the State of the Sciences and Literature in the Low Countries from the Year 1792 to 1815, pointing out carefully the different Causes which contributed either to promote or retard the Cultivation of the Sciences and Literature.

The Academy proposes for the same time the two following historical questions:—

What was the State of Slavery in the Low Countries from the most remote Period till towards the End of the 13th Century? How was that State gradually abolished; and what Remains of it still continued till the Time of the Introduction of the new French Laws?

What was the State of the Population, Arts, and Manufactures and Commerce, of the Low Countries during the 15th and 16th Centuries?

The subject of this second question has been treated in a superior manner by M. Verhoeven for the two preceding centuries in a memoir crowned and published by the Academy in 1777; a memoir to which M. Des Roches has made important additions.* The 15th and 16th centuries furnish materials by no means less interesting than those that preceded them. The progressive increase of the population, of the arts and manufactures, and their different vicissitudes, the flourishing state of the commerce of the city of Bruges, and its decline towards the end of the 15th century, the considerable portion that remained to it during the first three quarters of the following century, and its almost total destruction during the last quarter of that century; the progress, successful commerce, and immense wealth of the city of Antwerp, during the greatest part of the 16th century, will present facts equally interesting for their object, and glorious for the nation.

The Academy had proposed at the sitting of the 20th November last this question:—

What are the Applications which may be made in our Manufactures, and in Domestic Economy, of Steam employed as a Vehicle of Heat?

Three memoirs on that question have been received. The Academy is of opinion that the memoir with this motto—

The true method of improving the arts consists less in describing their processes with accuracy than in bringing all their operations to general principles.

CHAPTAL, *Chimie Appl. Aux. Arts.*

containing many researches, experiments, and enlightened views,

* In the analysis of the memoir at the end of it, and tom. iii. of the *Memoires de l'Acad. Journ. des Seances*, p. 27—32.

both theoretical and practical, was worthy of the prize. Accordingly the gold medal was voted to its author, M. A. de Hemptine, apothecary at Brussels.

An *accessit* was voted to the memoir No. 3, with the motto—

Inventio fructus ingenii, perfectio temporis.

the author of which is M. Charles Delaveleye, manager of the water-mills at Tournay.

The Academy received 11 memoirs on the following question:—

As for some Years past the Orobanche has made great Ravages in our Provinces on the Clover, the Academy wishes to know what are the best Means of destroying that parasitical Plant, and of preventing its Reproduction?

Some of these memoirs exhibit botanical knowledge and good observations; but as none of them has solved the problem, it has been impossible for the Academy to adjudge the prize; and observing that the experiments hitherto made on the subject leave much to be desired, it does not think that at present the question could be proposed a second time with any chance of success: it thinks proper merely to vote a silver medal, by way of encouragement, to the author of the memoir, No. 5, with the motto—

Agriculturæ amator, quo nihil homine libero dignius;

which gives experiments useful for diminishing the multiplication of this plant. On opening the letter, it was found that the author of this memoir is M. F. Schaumans, an old farmer, who resides at present in Ghent.

The Academy proposes for the year 1818 the three following questions:—

FIRST QUESTION (already proposed in 1793).—*What are the Faults to which our different Bricks are subject? What are the Means of making them more perfect? What are the Materials and the Processes employed in the Northern Provinces of the Kingdom for certain Species of Bricks of which we are destitute?*

SECOND QUESTION.—*Can we from satisfactory Experiments, or from the Doctrine of determinate Proportions, establish with Certainty that the Radical of Muriatic Acid is a compound Body, or is it more probable that this Radical is a simple Substance? Supposing the Question incapable of being decided, which of the two Ways of viewing its Nature is most proper for simplifying the Theory of chemical Facts?*

THIRD QUESTION.—*French Printing Paper and English Paste-board (Cartons) having an acknowledged Superiority over those of other Countries, it is demanded in what that Superiority consists, and on what Causes it depends, whether local, or derived from the Materials or the Process; and how the same Manufacture might be extended in this Kingdom?*

The Academy proposes for the year 1819 this question:—

To determine in a given Place, and during a given Time, the Expenditure of the Water of a River, whose Breadth, Depth, and Descent, is known. To determine at the same Place, and during

the same Time, the Variations which take place in this Expenditure when the Breadth of the River is gradually diminished by any Obstructions whatsoever.

The prize for each of these questions will be a gold medal weighing 25 ducats. The memoirs, written legibly in Latin, French, Dutch, or Flemish, must be sent post paid before Feb. 1, 1818; and those written in answer to the last question before Nov. 1, of the same year; to M. Van Halthem, Register of the Second Chamber of the States General, and Provisional Secretary to the Academy.

The Academy requires the greatest accuracy in the citations: for this purpose the authors must take care to mark the editions and the pages of the books which they quote. They will not put their name to their works, but only a motto selected at pleasure. They will write it, likewise, upon a sealed letter, containing their name and address. Those who shall make themselves known in any way whatever, and those likewise whose memoirs come to hand after the limited time is expired, will not be allowed to stand.

IX. *Translator of Euler's Algebra.—Heat generated by the Rupture of Iron Bars.*

(To Dr. Thomson.)

SIR,

R. M. Academy, Aug. 21, 1817.

I find from the number of your Journal for August, which I saw but to-day, that there appears to have been some question respecting the translator of Euler's Algebra. This task was accomplished by the Rev. Mr. Hewlet; I merely superintended the printing of the second edition, and added the notes given at the end as illustrative of certain properties of numbers not demonstrated in the body of the work. It is, therefore, Mr. H. who has to claim the "honour of having introduced the excellent treatise in question to English readers."

While I am writing to you, I take the opportunity of proposing a query, which you, or some of your ingenious correspondents, may be disposed to answer:—

I have been for some time carrying on experiments with a view to establishing a correct theory of the strength and stress of wood and other materials; and was lately present at an experiment performed at the Iron Cable Manufactory of Capt. Brown, when a cylindrical bar of iron $1\frac{1}{2}$ inch in diameter was drawn asunder by a force of 43 tons. Before the rupture the bar lengthened about five inches, and the section of fracture was reduced about $\frac{2}{3}$ ths of an inch; and about this part a degree of heat was generated which rendered it unpleasant, if not in a slight degree painful, to grasp the bar in the hands.

I have been very handsomely furnished by Mr. Telford with many accurate and valuable experiments of a similar kind; also others by Capt. Brown; in many of which the same phenomena of the gene-

rated heat is noticed, although in others it is said no heat was observed. There is, however, I should imagine, but little doubt that a certain quantity of heat takes place in all cases, although it is in some more perceptible than in others: and I should esteem it a particular favour if you, or any of your correspondents, could suggest a satisfactory explanation of the phenomena. There is no external friction on the bar; and the only probable reason that I can assign is the internal friction amongst the particles, which however some persons to whom I have mentioned the circumstance do not seem to consider sufficiently conclusive.

I have the honour to be, Sir,

Your obedient servant,

P. BARLOW.

X. *External Application of Sulphurous Acid as a Remedy.*

Dr. De Carro, of whose ardent and successful attempts to propagate the vaccine inoculation in Austria we lately made honourable mention in a biographical sketch which appeared in our Journal, is now eagerly employed in prosecuting a set of experiments at Vienna to ascertain the value of sulphurous acid fumes externally applied, according to the method of Dr. Galès, of Paris, as a remedy in different diseases. Dr. de Carro has distributed amongst his friends the following short account of his institution:—

“Although the utility of sulphur, taken internally, applied by friction, and mixed with natural and artificial baths, in many chronic diseases of the skin, the joints, the glands, and the lymphatic system, has been acknowledged from time immemorial, the most enlightened physicians have long desired some mode of administering the vapour of this mineral rendered acid, and more penetrating by combustion; and this wish was particularly expressed by a great physician of this capital, J. P. Frank, in his *Épitome de curandis Hominum Morbis*, Cap. Psora.

“Many contrivances, more or less perfect, have been adopted at different times for the employment of the sulphurous acid fumigation; but none of them till the present have been so managed as to admit of being used without affecting the respiratory organs.

“At length, however, Dr. Galès, of Paris, has invented and brought to perfection a *Boîte Fumigatoire*, which appears to answer every purpose; and the success of which, since the year 1813, would appear almost incredible, were it not attested by the principal civil and medical authorities of Paris, and fully detailed in a memoir* published in 1816, and distributed by order of the French Government.

“Dr. Galès, who has obtained an exclusive privilege for this

* *Memoire et Rapports sur les Fumigations Sulfureuses appliquées au Traitement des Affections cutanées et de plusieurs autres Maladies.* Par J. C. Galès, Docteur en Médecine de la Faculté de Paris, &c. Imprimés par Ordre du Gouvernement. De l'Imprimerie Royal. Paris, 1816.

practice in the capital, and, as a national recompense, a pension for life of 6000 francs, has in his own house 26 sets of apparatus, for all of which he finds employment; and similar establishments, public and private, are daily multiplying throughout France.

“ Struck with the great advantages of this remedy, I have established an institution for its exhibition, after having obtained the consent of the Imperial Government of Lower Austria, who have inspected the situation and the plan. I have devoted four chambers, containing two sets of apparatus, one for females, and the other for males, provided with proper attendants for each sex. The number of chambers, and the extent of the apparatus, will be increased according to its success. In order to be the more secure, and to avoid the difficulties inseparable from an imitation, I have procured the apparatus from Paris, constructed under the direction of Dr. Galès.

“ The employment of the fumigation will never be left to the discretion of the patient; and no one will be admitted until he has consulted me, either alone, or in concert with other medical men.

“ Wishing to facilitate beyond the capital, and in foreign countries, the adoption of this remedy, I shall always have, according to the example of Dr. Galès, sets of apparatus, made under my own eye, for those who require them; and these will be accompanied with small explanatory models, capable of being taken to pieces, in order to point out exactly the disposition of the different parts.”

(Signed)

DE CARRO, M.D.

Vienna, July 15, 1817.

XI. *Expanding Rigger.*

(To Dr. Thomson.)

SIR,

Through the medium of your *Annals*, I beg leave to inquire whether a smooth wheel of variable radius, or what mechanics term an expanding rigger, has ever been applied to any machine, in connexion with a centrifugal regulator, for the purpose of equalizing the velocity of the working part of the machine when the driving power is subject to sudden and considerable variation? An answer to this inquiry, by any of your readers possessing the requisite information, will be esteemed a favour, by,

Sir, your obliged and obedient servant,

Brimscomb, Aug. 15.

A. M.

XII. *Mill-stones.*

(To Dr. Thomson.)

SIR,

What description of stone is that which is commonly employed for constructing flour mill-stones, called French burs? Each mill-stone is formed of several burs, hewn into shape, and cemented together. They are also hooped with iron. A pair of stones of this

kind, which are considered the best in use, cost upwards of 20*l*. Have we no stones equally fit for the purpose in England?

Churn Cottage.

S. WEBB.

The French bur-stone is a kind of vesicular quartz, found in the formations round Paris. No stone answering the purposes of a mill-stone so well has ever been found in Britain. Tolerable mill-stones are made in Scotland from green-stone.—T.

XIII. *Inverted Rainbow.*

(To Dr. Thomson.)

SIR,

Perhaps you may think the following notice deserving a place in a less perishable record than the one from which it is extracted:—

“ We hear from Canterbury that on Friday last, about noon, a large ball of fire was seen to pass over that city, which was followed by a storm that broke almost all the windows in the town; and the next morning three suns appeared in the sky, attended with a rainbow inverted, which lasted from nine till twelve, to the great astonishment of the inhabitants.” (The Cirencester Flying Post, Dec. 28, 1741, No. 54.)

A. M.

XIV. *Chemical Equivalents.*

(To Dr. Thomson.)

SIR,

If not inconsistent with your plan, I request, in behalf of several chemical students, that you will do us the favour to insert in a number of the *Annals* a table of chemical equivalents, for the purpose of laying them on slide-rules. Stating what you consider the most accurate numbers would render a reference to the authorities unnecessary.

Z.

In the new edition of my System of Chemistry, which will be published in a few weeks, I have been at considerable pains to determine the weights of the atoms of bodies according to the best data at present in the possession of chemists. I refer my Correspondent to that work for the table which he desires to have.—T.

XV. *On impregnating Water with Carbonic Acid by the Syringe of Mr. Brooke's Blow-pipe.*

(To Dr. Thomson.)

SIR,

It appears to me that the condensing syringe of Mr. Brooke's blow-pipe may be applied with advantage to the purpose of impregnating water with carbonic acid.

A (Plate LXXII. Fig. 6) represents an urn to contain the water. B, the condensing syringe. C, a silk bag to contain

the gas. D, a funnel, furnished with a stop-cock, to replenish the urn with water. When fresh water is to be introduced, the syringe is to be removed, and the silk bag connected with the stop-cock, E, in order that the expelled gas may not be lost. When the gas is to be introduced, the syringe may be screwed on to either of the stop-cocks, E or F, as may be found most convenient.

If the idea has sufficient novelty to find a place in your Journal, by inserting it you will oblige your humble servant,

T. GLOVER.

XVI. Lectures.

Dr. Marcet proposes to give a Course of Clinical Lectures at Guy's Hospital during the next winter. And Mr. Bell will give a Course of Lectures on the Treatment and Diseases of the Teeth.

Mr. T. J. Pettigrew, F.L.S. Surgeon-Extraordinary to their Royal Highnesses the Dukes of Kent and Sussex, will commence his Winter Course of Lectures on Anatomy, Physiology, and Pathology, on Friday, Oct. 17, at eight o'clock in the evening precisely. The Lectures will be continued every succeeding Wednesday and Friday, at the same hour, until completed.

Mr. Guthrie, Deputy Inspector of Military Hospitals, will commence his Autumn Course of Lectures on Surgery on Monday, Oct. 6, at eight in the evening, in the Waiting Room of the Royal Westminster Infirmary for Diseases of the Eye, Mary-le-bone-street, Piccadilly.

Mr. Clarke will begin his Lectures on Midwifery, and the Diseases of Women and Children, on Friday, Oct. 10, at No. 10, Saville-row, Burlington Gardens.

Mr. Gaultier will deliver in the ensuing season two Courses of Lectures on the Physiology of the Human Body, at No. 10, Frith-street, Soho-square. The Lectures will be given on Monday and Thursday evenings, at a quarter past eight o'clock, after the Surgical Lectures are concluded. The Introductory Lecture of the First Course will be on Thursday, Oct. 9.

The following arrangements have been made for Lectures at the Surry Institution during the ensuing season:—

1. On Ethics; by the Rev. W. B. Collyer, D.D. F.S.A. To commence on Tuesday, Nov. 4, at seven o'clock in the evening precisely, and to be continued on each succeeding Tuesday.

2. On Chemistry; by James Lowe Wheeler, Esq. To commence on Friday, Nov. 7, and to be continued on each succeeding Friday.

3. On the British Poets, from Chaucer to Cowper, by Wm. Hazlitt, Esq. To commence early in January, 1818.

4. On Music; by W. Crotch, Mus. D. Professor of Music in the University of Oxford. To commence early in February, 1818.

Colonel Beaufoy's Magnetical

(Oct.

ARTICLE IX.

Magnetical and Meteorological Observations.

By Col. Beaufoy, F.R.S.

Bushey Heath, near Stanmore.

Latitude 51° 37' 42" North. Longitude west in time 1' 20.7".

Magnetical Observations, 1817. — Variation West.

Month.	Morning Observ.		Noon Observ.		Evening Observ.	
	Hour.	Variation.	Hour.	Variation.	Hour.	Variation.
Aug. 1	8h 35'	24° 31' 09"	1h 40'	24° 42' 04"	6h 55'	24° 35' 20"
2	8 35	24 29 50	1 35	24 43 10	6 55	24 33 32
3	8 35	24 33 56	1 35	24 43 58	6 55	24 34 03
4	8 35	24 30 58	1 40	24 42 00	6 55	24 33 50
5	8 35	24 31 08	1 35	24 43 52	6 55	24 34 10
6	8 35	24 30 55	1 45	24 40 39	6 55	24 33 54
7	8 40	24 30 35	1 45	24 43 50	6 55	24 33 56
8	8 35	24 31 15	1 40	24 42 42	7 00	24 32 27
9	8 35	24 30 38	1 30	24 42 40	7 00	24 33 41
10	8 40	24 30 45	1 35	24 41 04	6 55	24 33 20
11	8 35	24 31 37	1 35	24 43 19	—	—
12	8 35	24 30 57	1 35	24 43 56	6 55	24 33 36
13	8 35	24 31 32	1 35	24 43 03	7 00	24 33 03
14	—	—	1 55	24 43 15	6 55	24 34 13
15	8 35	24 29 40	1 35	24 41 35	6 55	24 34 31
16	8 35	24 31 42	1 35	24 43 54	—	—
17	8 40	24 30 25	1 30	24 41 30	6 55	24 34 00
18	8 35	24 28 29	1 35	24 44 44	—	—
19	8 35	24 34 20	1 55	24 41 42	6 55	24 29 38
20	8 30	24 32 46	1 35	24 43 30	6 55	24 34 47
21	9 10	24 31 38	1 40	24 41 01	6 55	24 34 26
22	8 40	24 30 42	1 45	24 42 39	6 55	24 33 58
23	8 35	24 31 32	1 45	24 43 36	6 55	24 35 16
24	8 35	24 31 22	1 45	24 43 51	6 55	24 34 26
25	8 30	24 32 47	—	—	6 55	24 33 26
26	8 40	24 30 10	1 40	24 42 23	6 55	24 34 13
27	8 35	24 32 12	1 35	24 41 58	6 55	24 34 26
28	8 40	24 37 25	—	—	7 15	24 31 20
29	8 40	24 29 30	1 55	24 43 47	—	—
30	8 40	24 30 28	1 25	24 43 14	6 50	24 33 37
31	8 35	24 32 39	1 50	24 43 31	6 50	24 34 06
Mean for Month.	8 37	24 31 26	1 39	24 42 51	6 57	24 33 45

Aug. 19.—In the morning Bushey Heath was immersed in a cloud.

Meteorological Table.

Month.	Time.	Barom.	Ther.	Hyg.	Wind.	Velocity.	Weather.	Six's.
		Inches.				Feet.		
Aug. 1	Morn....	29.334	56°	63°	W by N		Fine	47°
	Noon....	29.377	66	46	NW	12.704	Showery	66
	Even....	29.400	61	48	W by N		Fine	} 49
	Morn....	29.510	58	57	W		Very fine	
2	Noon....	29.517	66	41	WNW	9.225	Very fine	69
	Even....	29.585	62	45	W		Cloudy	} 54
	Morn....	29.305	56	70	SSW		Drizzle	
3	Noon....	29.288	63	51	W	21.675	Showery	67
	Even....	29.295	59	50	W by S		Very fine	} 49
	Morn....	29.345	55	68	W by S		Sm. rain	
4	Noon....	29.325	60	50	W	22.931	Showery	66
	Even....	29.310	60	52	W		Fine	} 55
	Morn....	29.523	58	60	NNE		Fine	
5	Noon....	29.605	66	45	N	6.566	Fine	68
	Even....	29.600	63	47	Calm		Fine	} 54
	Morn....	29.650	61	66	SSE		Fine	
6	Noon....	29.645	68	44	SSW	10.977	Cloudy	70
	Even....	29.595	62	45	SSE		Fine	} 53
	Morn....	29.485	60	54	ESE		Cloudy	
7	Noon....	29.435	71	43	S by W	5.836	Fine	71
	Even....	29.363	65	47	SSE		Cloudy	} 58
	Morn....	29.095	60	84	SSW		Rain	
8	Noon....	29.110	61	58	W by S	26.399	Showery	65
	Even....	29.200	58	50	WSW		Fine	} 50
	Morn....	29.270	58	59	WSW		Fine	
9	Noon....	29.300	62	53	WSW	25.189	Showery	64
	Even....	29.375	59	52	W by N		Fine	} 52
	Morn....	29.400	57	65	WSW		Cloudy	
10	Noon....	29.400	60	55	WNW	10.934	Showery	65
	Even....	29.412	59	50	WNW		Very fine	} 48
	Morn....	29.390	57	61	S by W		Cloudy	
11	Noon....	29.300	63	56	SSW	13.939	Cloudy	66
	Even....	29.173	59	63	SSE		Rain	} 54
	Morn....	29.973	57	60	SW by W		Fine	
12	Noon....	29.973	63	49	SW	17.715	Showery	65
	Even....	29.973	56	63	SW by S		Showery	} 54
	Morn....	28.800	57	74	W by N		Showery	
13	Noon....	29.054	64	47	W	28.624	Fine	65
	Even....	29.180	59	53	W by S		Fine	} 56
	Morn....	29.250	60	85	SW		Rain	
14	Noon....	29.234	65	70	SSW	25.326	Showery	67
	Even....	29.200	65	60	SSW		Showery	} 56
	Morn....	29.283	58	73	WSW		Showery	
15	Noon....	29.337	65	49	W by S	28.404	Fine	66
	Even....	29.410	59	52	SW		Fine	} 52
	Morn....	29.450	61	63	SSW		Fine	
16	Noon....	29.360	65	46	SSW	11.625	Fine	66
	Even....	—	—	—	—		—	} 50
	Morn....	29.267	57	60	WSW		Fine	
17	Noon....	29.293	62	52	W	26.627	Showery	63
	Even....	29.337	58	55	W		Showery	} 49
	Morn....	29.515	56	68	W		Cloudy	
18	Noon....	29.520	61	52	SW by S		Cloudy	62
	Even....	—	—	—	—		—	

Meteorological Table continued.

Month.	Time.	Barom.	Ther.	Hyg.	Wind.	Velocity.	Weather.	Six's.
Aug.		Inches.				Feet		
19	Morn....	29-277	60°	85°	WSW		Cloudy	55°
	Noon....	29-257	64	81	SW		Showery	66
	Even....	29-217	61	83	SSW		Cloudy	} 56
Morn....	29-190	60	61	W by S		Cloudy		
20	Noon....	29-200	64	51	SW by W		Cloudy	66
	Even....	29-200	59	58	SW		Cloudy	} 53
Morn....	29-300	54	75	NNE		Rain		
21	Noon....	29-400	56	70	NNE		Showery	60
	Even....	29-500	55	61	N		Fine	} 44
Morn....	29-657	52	65	NNE		Very fine		
22	Noon....	29-663	60	45	Var.		Cloudy	62
	Even....	29-660	55	60	Calm		Fine	} 45
Morn....	29-592	53	59	ESE		Very fine		
23	Noon....	29-526	62	45	SSE		Cloudy	63
	Even....	29-480	56	58	E		Cloudy	} 51
Morn....	29-335	57	55	E by S		Cloudy		
24	Noon....	29-275	57	64	ESE		Showery	62
	Even....	29-160	57	57	ESE		Showery	} 52
Morn....	28-843	57	80	SSE		Showery		
25	Noon....	28-700	59	80	SSE		—	64
	Even....	28-660	61	73	SSW		Fine	} 56
Morn....	28-624	61	71	SSE		Showery		
26	Noon....	28-565	65	65	S		Showery	65
	Even....	28-540	55	73	SSW		Showery	} —
Morn....	28-720	60	70	W		Fine		
27	Noon....	28-815	62	61	W		Showery	64
	Even....	28-910	57	66	W by N		Showery	} 53
Morn....	29-205	59	61	WNW		Fine		
28	Noon....	—	—	—	—		Cloudy	63
	Even....	29-285	57	61	WSW		Cloudy	} 54
Morn....	29-178	57	70	W		Cloudy		
29	Noon....	29-223	63	60	W		Showery	66
	Even....	—	—	—	—		—	} 50
Morn....	29-460	56	68	W		Fine		
30	Noon....	29-462	63	58	S by W		Drizzle	66
	Even....	29-445	59	64	S by E		Cloudy	} 55
Morn....	29-400	58	66	WSW		Fine		
31	Noon....	29-427	64	51	SW		Showery	67
	Even....	29-483	58	58	SW		Fine	

Aug. 17.—The wind machine was spoiled by the breaking of the pivot.

ARTICLE X.

METEOROLOGICAL TABLE.

17.	Wind.	BAROMETER.			THERMOMETER.			Hygr. at 9 a. m.	Rain.
		Max.	Min.	Med.	Max.	Min.	Med.		
1 Mo.									
Aug. 5	N E	30·05	30·00	30·025	70	48	59·0	47	
6	N E	30·00	29·85	29·925	74	40	57·0	44	C
7	N W	29·83	29·45	29·640	75	55	65·0	44	
8	S W	29·58	29·45	29·515	67	48	57·5	55	
9	W	29·72	29·59	29·655	71	45	58·0	44	
10	S W	29·72	29·71	29·715	71	34	52·5	50	10
11	S W	29·72	29·33	29·525	71	48	69·5	52	—
12	S W	29·33	29·17	29·250	68	52	60·0	50	45
13	S W	29·55	29·33	29·440	67	54	60·5	55	
14	W	29·61	29·55	29·580	71	54	62·5	62	3
15	W	29·78	29·55	29·665	68	46	57·0	48	4
16	S	29·58	29·55	29·565	70	48	59·0	45	22
17	W	29·87	29·59	29·730	66	45	55·5	50	6
18	S W	29·64	29·59	29·615	66	54	60·0	49	28
19	S W	29·64	29·55	29·595	68	54	61·0	60	6
20	W	29·64	29·55	29·595	69	50	59·5	50	—
21	N W	30·02	29·64	29·830	59	42	50·5	64	12
22	E	30·02	29·94	29·980	63	35	49·0	50	
23	S E	29·94	29·68	29·810	67	48	57·5	58	
24	S	29·68	29·20	29·440	65	50	57·5	45	—
25	S W	29·20	29·00	29·100	62	48	55·0	63	29
26	S	29·08	28·90	28·990	64	44	54·0	55	15
27	S W	29·55	29·08	29·315	68	51	59·5	48	3
28	S W	29·64	29·54	29·590	68	51	59·5	50	12
29	W	29·80	29·64	29·720	69	47	58·0	53	
30	S W	29·80	29·75	29·775	71	54	62·5	53	18
31	S W	29·95	29·75	29·850	67	41	54·0	53	
1 Mo.									
Sept. 1	N E	29·98	29·95	29·965	69	37	53·0	64	
2	E	29·98	29·83	29·905	69	48	58·5	58	
		30·05	28·90	29·631	75	34	57·65	52·3	2·13

e observations in each line of the table apply to a period of twenty-four hours, beginning at 9 A. M. on the day indicated in the first column. A dash indicates, that the result is included in the next following observation.

REMARKS.

Eighth Month.—21. A wet morning: windy at N: p. m. cloudy, with wind about NNW: pretty calm at night. 22. Fair, with *Cirrostratus* beneath *Cirrus*: gold-coloured moon: calm at night. 23. Fine morning: there is said to have been hoar frost: a few *Cumuli* appeared, which soon became heavy *Cumulostratus*: and in the evening it was quite overcast, with a few drops of rain. 24. Fine, a. m.: the wind SE: a little rain, p. m.: during the day a singular anomalous veil of cloud overspread the sky, in which the *Cirrostratus* on the whole predominated: the lower surface of these clouds put on fine crimson and grey tints at sun-set, and the lights formed by the moon shining through them were peculiarly soft and pleasing. 25. Cloudy, a. m.: small rain: the wind gentle, veering to S: it rained much of the day at intervals: afterwards appeared groups consisting of *Cumulostratus* and *Cirrocumulus*, with *Nimbi*: hazy moonlight. 26. *Cirrostratus* in the morning: then *Nimbus*, and some rain: the wind gone back to SE, and moderate: many sudden showers of small amount from ill-defined clouds amidst haze: a bow soon after three, p. m.: windy night. 27. Fine morning: much dew: calm: *Cumulostratus* tending to *Cirrocumulus* above: some rain at mid-day. 28. Fine morning: *Cumulus* passed to *Cumulostratus*: a very few drops fell, p. m.: and there followed wind, succeeded by calm, with *Cirrostratus* and haze: rain in the night. 29. Fair: brisk wind, with various clouds. 30. A veil of *Cirrostratus* in flocks, a. m., with this *Cumulus* rapidly incalculating, formed *Cumulostratus*, which was heavy through the day: in the evening much *Cirrostratus*, succeeded by small rain: in the night a heavy shower. 31. Fine, with *Cumuli*, carried by a strong breeze.

Ninth Month.—1. Misty morning, with *Cirrostratus* above, to which succeeded *Cumulostratus*. 2. Fine morning: wind NE, with *Cirrostratus*, which gave place to *Cumulus*: the evening was overcast, as for rain, but little or none fell, and in the night there was a most copious fall of dew.

RESULTS.

Winds Westerly, save twice about the last quarter of the moon, when they became Easterly.

Barometer: Greatest height.....	30.05 inches.
Least	28.90
Mean of the period	29.63
Thermometer: Greatest height.....	75°
Least	34
Mean of the period.....	57.65
Mean of the Hygrometer.....	52.3
Rain.....	2.13 inches.

The following was communicated to me by my friend Thomas Forster:—

“*Tunbridge Wells, Oct. 6, 1817.*—Being out about midnight, and the sky being remarkably clear, wind SW, therm. 49°, I saw in the WSW a brilliant meteor, almost half the apparent bigness of the moon: it began at about 45° or 50° of altitude, and slowly descended, increasing in size: it might perhaps be near 10 seconds in falling: the colour of the flame was white till near its extinction, when it was bright blue, tinged with reddish at the top.—T. F.”

ANNALS
OF
PHILOSOPHY.

NOVEMBER, 1817.

ARTICLE I.

Biographical Account of William Brownrigg, M.D. F.R.S.
By Joshua Dixon, M.D.*

THE occurrences in the lives of literary characters are seldom so extraordinary as to awaken interest, or gratify curiosity. Removed from the active and busy scenes of the world, and experiencing few vicissitudes of fortune, they glide down the stream of time with that silent uniformity which neither attracts, nor deserves, the notice of men. To the physician this observation is particularly applicable. The completion of his most sanguine expectations never terminates in any high elevation of rank, or dignity of station: and in a public capacity he has no opportunity of distinguishing himself, however qualified he may be to shine in it, from the gifts of nature, and the acquisitions of study. The possessors of those honours which exclusively belong to the other professions may, by their weight in the scale of politics, become objects of general attention. The contrast also between the glimmering dawn of their prospects, and their subsequent splendour, produces surprise and perplexity in the inquisitive mind; and every minute circumstance which has been the immediate or remote cause of so rapid and singular a promotion hence derives an importance to which it has no

* This life was published at Whitehaven in 1801. It was written by Dr. Dixon, the principal physician of that part of the country, who had been an apprentice of Dr. Brownrigg. I have been induced to reprint it here because it contains much curious and important matter, which ought to be known to the scientific world; and I have reason to believe that the circulation of the original has been very limited.—T.

intrinsic claim. Rarely, on the contrary, does any striking and wonderful event rescue the physician from oblivion : on his scientific attainments depends his future celebrity.

These introductory remarks are designed to apologize for the deficiency of incident in the life of Dr. Brownrigg ; whose title to the regard of mankind rests not on the capricious distributions of fortune, but on the firm foundation of personal merit.

The medical education of Dr. Brownrigg * commenced at London, where he attended public lectures two years. He then proceeded to Leyden ; and, from the date of his inaugural dissertation, it appears that the degree of Doctor of Medicine was conferred upon him in 1737. To that University, which had obtained unrivalled celebrity and estimation, medical students generally resorted ; and from it they derived the greatest improvement, and the highest honours of their profession. In this learned seminary the Doctor remained several years, and studied the theory and practice of physic, anatomy, botany, and experimental philosophy, under the auspices of their respective, most illustrious, professors, Boerhaave, Albinus, Van Royen, and s'Gravesande. To these his intimate friends, and much revered preceptors, he dedicated, with affection and respect, his elaborate thesis *De Praxi Medicâ ineundâ* : an inquiry well adapted to the situation of one who, conversant with the theory, was about to engage in the practice, of medicine.

In treating this important subject he has very ingeniously given heads of discussion with regard to the state of the air, that of the climate, and other contingencies affecting the place where the physician proposes to reside. To these are annexed useful rules, and judicious advice, for the assistance and direction of medical students, relative to the characteristic temperament and constitution of its inhabitants, their mode of living, their particular articles of diet, the diseases and infirmities to which they are peculiarly liable, and the means which have been proved from experience to be adequate to their immediate relief, or permanent removal. Many other circumstances are added, which might be read with advantage by young physicians.

As soon as Dr. Brownrigg had entered upon the practice of medicine at Whitehaven, in his native county, he began, with judgment and perseverance, to put in execution the measures qualified to accomplish the plan which he had thus laid down : and, among other inquiries, the damps † or exhalations arising in the coal-mines, with which that town is surrounded, appeared to him deserving of careful and accurate examination. So extraordinary were their effects, that he employed much of his leisure time in investigating their properties. Earnestly solicited by the late Sir

* Dr. Brownrigg was born at High Close Hall, in the county of Cumberland, on March 24, 1711 ; and was married to Mary, the daughter of John Spedding, Esq. on Aug. 3, 1741.

† In the Saxon and German languages, a vapour or exhalation is expressed by the word *damp*.

James Lowther, Bart. proprietor of the mines, to engage in this arduous undertaking, he was encouraged in the prosecution of it by motives of humanity: justly supposing that a more extensive acquaintance with subterraneous exhalations might lead to the discovery of some more effectual method for preventing their dreadful consequences, and for rendering them less fatal and destructive. He was animated, moreover, by the prospect that such an inquiry would ultimately be subservient to the cure, as well as to the prevention, of those diseases which are incident to miners; since the cause, when ascertained, could be counteracted with greater probability of success; and that obscurity would disappear with which the indications of cure had hitherto been involved. Entertaining, at the same time, a well grounded opinion that the principal energy and virtue of mineral waters consist in their impregnation with certain exhalations, which are similar in their nature either to the fire or to the choak-damp, he conceived that an elucidation of this abstruse and mysterious subject would contribute, in another respect, to alleviate the pains and sufferings of man, and to enlarge the boundaries of medical knowledge; as we would thus obtain a rational and satisfactory solution of those perplexing difficulties which arise from an ignorance of the component parts of mineral waters, and from the uncertainty of their operations upon the human constitution. Impressed also with a conviction that epidemical diseases were often the effect of mineral exhalations, he hoped that his researches would terminate in a discovery of their nature and remedies.

With a view to excite the attention of philosophers to such subjects, and to promote a spirit of experimental inquiry, he wrote several essays on those exhalations; which in the year 1741 were presented by Sir James Lowther to the Royal Society of London, by whom they were received with distinguished approbation; and the Doctor was, in consequence, unanimously elected a member of that learned body. To these essays, then transmitted to the Royal Society, he added, in the year 1746, another, in the form of a letter to Sir James Lowther, containing an account of a laboratory which he had erected in the neighbourhood of Whitehaven. By the favour of Sir James Lowther, it was supplied with a constant stream of inflammable air, or fire-damp. In this laboratory many curious experiments were made upon that subtile body; and by its application as a substitute for fire, several chemical operations performed, requiring a long continued and determined degree of heat. According to a method discovered by Mr. Carlisle Spedding, the fire-damp was conveyed up an adjacent pit, from which it was conducted, through a leaden pipe, to Dr. Brownrigg's laboratory. For its reception he invented several furnaces of such a construction as to be capable of affording the most intense or the most gentle heat. In the prosecution of his inquiries he experienced occasional interruptions, from certain irregularities in the quantity and motion of the fire-damp; which were the effect of a sudden transition of the

atmosphere, either from a rarified to a dense, or from a dense to a rarified state. As the stream of fire-damp which he used was small, his experiments were upon a very limited scale. In places, however, where there is a perpetual and abundant supply of inflammable air, chemical preparations might be conducted according to this plan, not only with greater accuracy and success, but also with less inconvenience and expense, than by the processes usually practised.

The honour which the Royal Society proposed to confer upon Dr. Brownrigg, by inserting these essays in their Philosophical Transactions, was declined by him; as it was his intention to publish them on some future occasion, enlarged and improved by many additions and corrections. For this purpose he collected and arranged, with the greatest diligence and assiduity, all that occurred in the writings of ancient and modern authors which had an immediate or remote connexion with the subject: and having provided a suitable apparatus, he performed a great number of experiments, with a view to ascertain the effects of stagnation upon several kinds of air, and the operation of these airs upon animal life, both in a simple state, and when combined with each other. Desirous also that his observations should be confirmed, not only by his own experiments, but by the attestations of others, he solicited and received the opinions of many of his literary friends, particularly of Sir Hans Sloane and Dr. Hales. Furnished with necessary materials, and qualified for the execution of so difficult a task, by his indefatigable perseverance, and his partial attachment to chemical philosophy, he long had it in agitation to write a general history of damps. With this motive, he retired many years ago from professional avocations, to his paternal seat, Ormathwaite, near Keswick: "Non fuit enim consilium socordiâ atque desidiâ bonum otium conterere." * The outlines, indeed, of his history of damps, having been sent to Dr. Hales for his private perusal, were submitted by that celebrated philosopher to the inspection of the Royal Society; but, notwithstanding the importunities of those who were able to appreciate their merits, he could never be prevailed upon to give his consent to their publication. An incontestable argument, however, of his attention to the properties of damps, and of the deference which was paid to his judgment, arises from his being frequently consulted when an explosion in the mines was apprehended. By observing the degree of rapidity with which the mercury descended in the barometer, he could foretel the exact period of an explosion; and his predictions were too frequently verified by some melancholy event.

The only work which he has permitted to be published upon the subject of damps is an Extract of an Essay on the Uses of a Knowledge of mineral Exhalations, when applied to discover the Principles and Properties of mineral Waters, the Nature of burning Fountains, and those poisonous Lakes called Avernî. This ingenious

* Sallust.

tract was read before the Royal Society in April, 1741. The object of it is to prove that the distinguishing qualities of mineral waters depend on a particular kind of air, which forms a considerable part of their composition; and that this air differs in no respect from the choak or fire-damp.

It appears to have been long the united sentiment of philosophers that the properties of mineral waters are not derived from the grosser particles of mineral bodies which they dissolve in their passage through the bowels of the earth, but from a subtile principle, which spontaneously evaporates when exposed to the air. Although their ideas, with regard to the existence and the use of this principle, were perfectly conformable to truth, yet they erred in supposing that it was distinct in its nature from the air of such waters, and that it could be detached from them in the form of a liquid, or of some visible substance. The celebrated Hoffman was the first who endeavoured to correct this mistaken opinion; and who demonstrated that the principle of these waters imparts to them a peculiar sprightliness, prevents their putrefaction, and renders them efficacious remedies in many diseases which are incident to the human frame. After declaring the coincidence of his own sentiments with those of Hoffman, Dr. Brownrigg proceeds to show the difference of this elastic fluid from common air. Contrary to an opinion then generally received, he asserts it to be an unjust conclusion that their perfect agreement is sufficiently proved from the common property of elasticity. Bodies dissimilar to each other in solidity, form, and size, possess an equal degree of elasticity: and hence it is probable that the same difference exists between those elastic fluids which are separated from various substances as exists between the substances themselves.

From the obvious importance of the inquiry, he is next led to the consideration of the manner by which this principle enters into mineral waters. The fire-damp produced from strata of sulphur or pyrites insinuates itself, by its natural elasticity, into the water which is confined in the same cavities with itself, and communicates to that body its own essential qualities. Hence arises a rational explanation of the origin of mineral waters; and thus we are enabled to account for all their varieties, since they are equally capable of receiving into their composition those other kinds of air which they meet with in their subterraneous passage. It is evident, therefore, that damps and this mineral elastic fluid differ neither in their properties nor in their mode of generation. To an ignorance of these damps Dr. Brownrigg justly ascribes the imperfect and unsatisfactory manner in which Hoffman has treated upon mineral waters, and the erroneous opinions which he has sometimes advanced. For forming a more accurate distinction of their several kinds, and for ascertaining their respective affinity to subterraneous exhalations, he judiciously recommends a careful examination and comparison of their aerial principles.

Exclusively, however, of such an experimental inquiry, the facts

and observations which are already in our possession clearly establish the relation of the waters stiled acidulæ to the choak-damp. This relation is proved by mephitic expirations, at a very inconsiderable distance from such springs, and by the similarity of their effects upon animal life. The existence also of these exhalations in the acidulæ further appears from the almost instantaneous death of animals which swim upon their surface, and by their power of exciting stupor, vertigo, and the usual symptoms of intoxication. The resemblance of this elastic fluid to the air of fermenting liquors is an additional proof of its agreement with the choak-damp, since the external application of both is equally injurious to life. The air, moreover, of fermenting liquors, which may be considered as synonymous to the choak-damp, when inhaled in moderate portions, possesses, according to Dr. Brownrigg's observation, great influence in restoring and preserving health; as was particularly exemplified in the case of Cornaro. And, in like manner, equal benefit has resulted from the use of mineral waters; which invigorate the system, remove obstructions, dissolve concretions, and facilitate the respective functions of the several organs of the human body.

The remaining part of this essay is employed in proving that sulphureous waters are indebted for their remarkable properties to their impregnation with a kind of air exactly corresponding to the fire-damp. For this purpose he made several accurate experiments, as well upon them as upon water impregnated with native and with artificial fire-damp. From the similarity in their sensible qualities, he naturally inferred that the aerial principle of this species of mineral waters was in every respect the same as the fire-damp. The cause of burning fountains may hence be referred to a superabundance of the fire-damp, or to its imperfect combination with the water. And hence also the poisonous lakes called Avernî seem to derive their fatal effects from the expiration of some portion of the choak-damp at the same aperture in the earth.

In speaking of this essay, it is scarcely possible to praise it more than justice to its merits requires. It contains, in the first place, a very curious and important discovery, viz. that the impregnation of the acidulæ with the choak-damp,* and of sulphureous waters with the fire-damp, is the sole cause of their characteristic taste, smell, and properties. It appears, likewise, that Dr. Brownrigg had discovered a method of obtaining an artificial fire-damp, and of impregnating water with fire-damp; or, to use his own expression, "of dissolving the particles of the fire-damp in water by art." It may not in this place be improper to observe, that the imitation of the Pymont water by impregnating water with fixed air was the discovery of Dr. Brownrigg, by whom it was originally hinted to Dr. Priestley.†

* The fire-damp contains a small proportion of hepatic air.

† The processes which he used for these respective purposes cannot be ascer-

This essay was annexed by way of explanation to a paper written by Dr. Brownrigg, and inserted in the 55th volume of the Philosophical Transactions for the year 1765, intituled, An experimental Inquiry concerning the mineral elastic Spirit or Air contained in the Waters of Spa, in Germany, as well as into the mephitic Qualities of that Spirit.

From the preceding remarks it appears to have been Dr. Brownrigg's firm persuasion that a discovery of the qualities of the air which peculiarly distinguishes the acidulæ, and with which they are abundantly supplied in the interior parts of the earth, would improve our knowledge of their nature and properties, and that the efficacy of their operation upon the human body is proportioned to the quantity of this air contained in their composition. He seized, therefore, with eagerness, the favourable opportunity which presented itself, during a short residence at Spa, in Germany, of determining the degree of impregnation with fixed air which takes place in its celebrated waters, by submitting them to the test of accurate experiments.

In the first experiment he endeavoured to detect the separation of this elastic fluid, by a careful exclusion of the external air, supposing that, when the pressure of the atmosphere was removed, it would by its own expansive force escape into bladders, which were connected with phials of Pothon water. In this expectation, however, he was disappointed, as he could not discover any apparent discharge of air: on the contrary, the water, remaining perfectly transparent, still retained all its active and volatile qualities. This experiment was afterwards repeated, and every precaution adopted which could prevent the access of the atmospheric air. The vials continued seven days in a degree of heat equal to above 80° of Fahrenheit's thermometer; yet during this period no separation of air occurred, and the water, when accurately examined, exhibited proofs of its pungent and elastic properties being increased. This circumstance was more extraordinary, as various experiments show that the air of several mineral waters may be easily disengaged when subjected to the same treatment. That heat, however, possessed some influence in dislodging the air, was evident, from the water having acquired a more brisk appearance; yet we are not hence, he very justly adds, to impute accidents happening to bottles containing this water, to the escape of the air, but to the rarefaction of the water.

The second experiment relates to the effects of heat in extricating this elastic fluid. When a heat equal to about 110° of Fahrenheit's thermometer was communicated to a vial filled with Pothon water, the air rose with impetuosity into the bladder. By its constant separation the distention of the bladder was increased; and from

tained with accuracy at this distance of time; and the experiments, which are related in papers yet in existence, though never published, cannot on the present occasion be communicated to the world.

the same cause, white clouds were at length formed in the water, which, as the heat diminished, deposited its earthy particles. The water was found, on examination, to be wholly deprived of its characteristic qualities. From repeated experiments, Dr. Brownrigg concluded that, when the heat does not exceed what has been already mentioned, a shorter space of time than four hours would be insufficient for the purpose of dispossessing all the air. Another inference which he draws is, that an intimate union subsists between the other component parts and the air of the Pouhon water. The facts which occurred to his observation in the first experiment prove the justice of this inference; for although the weight of the atmosphere was taken off from this aerial fluid by confining the water in a close vessel, and although it was no more than a rational supposition that its elasticity would have caused its escape, yet even when heated to 80° of Fahrenheit's thermometer, and shaken violently for several days, no portion of it could be perceived to have been expelled. Its combination, therefore, with the other principles of the Pouhon water does not depend on any external pressure, but is naturally so firm that it cannot be destroyed, or even weakened, unless by a heat equal to 100° of Fahrenheit's thermometer. It was also remarked that the quantity of sediment was proportioned to the quantity of air discharged, an entire separation of which was essentially requisite to produce an entire decomposition of the water. The obvious conclusion is, that the air is the medium by which the earthy and metalline ingredients remain dissolved in the water.

By the third experiment the quantity of air with which the Pouhon water is impregnated was accurately determined. After proceeding in the same manner as in the second experiment, the vial was inverted, and the air, in consequence, which was before contained in the bladder, now occupied the upper part of the vial. A mark was then made where it was in contact with the surface of the water; and a quantity of fresh Pouhon water which stood at this mark, that is, was equal in bulk to the air, as being contained in the same part of the vial, was found to weigh 8 oz. 2 dr. 50 gr. apothecaries' weight. A quantity of water which exactly filled the vial was also found to weigh 20 oz. 7 dr. 14 gr. Admitting, therefore, that a cubic inch of water weighs 265 gr. it follows that $37\frac{2}{3}\frac{2}{3}$ cubic inches of the Pouhon water contained $15\frac{2}{3}\frac{2}{3}$ cubic inches of air. Allowances, however, must be made for any accidental variation in the state of the atmosphere. Its different degrees of density, temperature, and moisture, render it scarcely possible to arrive at accuracy in attempting to ascertain the proportion of this elastic fluid. From subsequent experiments, Dr. Brownrigg was induced to think that it was more abundant than he had originally supposed; as the intensity of the heat which he employed, injuring the texture of the bladders, prevented its total discharge.

The fourth and fifth experiments were performed for the purpose of discovering the comparative effects of atmospheric air and of the

air contained in the Pouhon water upon animal life. The apparatus which he used upon this occasion was his own invention; and, with a few alterations, has since that time been received into general use amongst chemists, as being best adapted for filling vessels with any particular kind of air, and for transferring it from one vessel to another. This apparatus consisted of a large cistern, or tub, filled with water; to the top of which was fixed a semicircular shelf, with circular holes and niches. A vial or receiver gradually inverted in the cistern was thus filled with water. It was then conveyed through the openings in the shelf so far as to leave the lower part of it covered with water, in which situation it was retained by means of wedges. Another vial, containing either the air of the Pouhon water, or common air, after being carefully corked, was placed directly under the mouth of the receiver. When the cork was withdrawn, the air contained in the vial rushed into the receiver, which at the same time discharged its water into the vial. In the receiver filled by this expedient with common air, a mouse remained one hour, without appearing to have received any injury; and it was only during the latter part of the hour that a small bird, confined in the same manner, gave signs, by its quicker respiration and slight convulsions, of suffering some degree of inconvenience; but when the air of the Pouhon water was emptied into the receiver, it proved in a very few moments fatal to several mice and small birds who breathed it.

This experimental inquiry was considered by the Royal Society of so singular and important a nature, that to the ingenious author of it, as the best original publication in the course of the year, Sir Godfrey Copley's honorary medal was unanimously adjudged.* At the conclusion of this experimental inquiry Dr. Brownrigg promised to transmit to the Royal Society further information respecting the separation of the air of the Pouhon water, and its various properties; together with an explanation of the manner in which the combination subsisting between the air of that water and its other principles is preserved. The performance of this promise was deferred till 1774, when he published a Continuation of an experimental Inquiry concerning the Nature of the mineral elastic Spirit, or Air, contained in the Pouhon Water, and other Acidulæ, which was inserted in the 64th volume of the Philosophical Transactions for that year. In this interval the Hon. Mr. Cavendish had demonstrated that fixed air suspends calcareous earths in water. Mr. Lane also had proved that it is capable of dissolving a large quantity of iron, and upon this principle had explained the nature and origin of chalybeats. The conclusions to which Dr. Brownrigg was naturally

* Sir Godfrey Copley originally bequeathed five guineas, which were to be presented at the anniversary meeting of the Royal Society, of the President and the Council, to the author of the best observations for the preceding year. A gold medal, as and a nobler object of ambition, was afterwards substituted in its place. to the decision of the experimental

led by the experiments and observations related in the continuation of his experimental inquiry coincide, in a great measure, with the result of the curious researches of the above-mentioned philosophers. These experiments and conclusions it was his intention, as appears from a letter to Sir John Pringle, prefixed to the continuation, to have submitted to the consideration of the Royal Society, some time before Mr. Cavendish and Mr. Lane made their respective discoveries; and it is, therefore, a necessary consequence that he has an equal title to the merit of these discoveries. Desirous of rendering his sentiments upon that subject more deserving the notice of the learned by further corrections and improvements, and retarded in the execution of so tedious an undertaking by professional avocations, he delayed their publication till the necessity of it was in some respect superseded by the investigations of Mr. Cavendish and Mr. Lane. Thus anticipated in his design, regardless of personal fame, and conceiving the object which had first excited his attention to such studies to have been already accomplished, viz. the improvement of science, he felt little inclination to communicate to the world the continuation of his inquiries; and it was with difficulty that he could at length be prevailed upon to comply with the importunate solicitations of his literary friends.

Not only, however, has Dr. Brownrigg an equal claim to these discoveries with Mr. Cavendish and Mr. Lane, but it is also probable that they are solely to be attributed to him. A careful examination of the experimental inquiry into the nature of the Spa waters must convince every unprejudiced person that the facts and opinions contained in it were the foundation of what has been considered as the discovery of those ingenious writers. It was there proved that the air of the Pouhon water is the common bond of union between all the other component parts, that during its presence the ferruginous and calcareous earths are held in a state of solution, that its separation is immediately followed by a proportional separation of these earths, and that when it is entirely extricated they are incapable of being any longer suspended, but are precipitated in the form of a thick sediment. By many these will no doubt be considered as sufficient proofs that Dr. Brownrigg is the sole and real discoverer of what has usually been ascribed to Mr. Cavendish and Mr. Lane.

In the continuation of his experimental inquiry Dr. Brownrigg principally endeavours to demonstrate the following propositions: 1. That the air of the Pouhon water dissolves and unites its martial and calcareous earths. 2. That this air is of an acid nature. After a summary but distinct detail of the experiments which he had already published, and from which it appears that heat, disengaging the air, is capable of decomposing the Pouhon water; he adds, that cold also is equally as well adapted to that purpose. This water, whilst congealing, was observed to discharge its air in large quantities, and gradually to acquire a more convex surface. When reduced to its former state of fluidity, it assumed a muddy aspect,

and the greater part of its calcareous and ferruginous earths was precipitated. Whether heat or cold was employed, no other body was expelled except fixed air; and hence he concluded that the reciprocal action of the air and of the earths is the cause of their union with the Pouhon water.

The substance which is thus formed by their mutual attraction and combination he considers as a species of neutral salts, having the same solvent, fixed air, but a different base, according to the different nature of the earths. The affinity of this air to those bodies which have been denominated purely saline is proved, he thinks, by the similarity of its properties; such as its solubility in water, its power of suspending metalline and calcareous earths, and its communicating to them an acidulous taste. The relation of the concrete, which is formed by the union of fixed air with the metalline and calcareous earths, to neutral salts, is confirmed by their being decomposed in the same manner, as, 1. By means of heat. 2. Of more powerful acids, which, displacing the air, combine with the metalline and earthy base. He here takes the opportunity of observing that the addition of vitriolic acid to the acidulæ does not possess any efficacy in preventing their putrefaction, as was the opinion of Dr. Hales and subsequent philosophers; but that the acid detaching the air unites with the earthy base, destroys the original composition of the water, and produces a new body, not so liable to corruption, but less salutary in its effects. 3. Of alkalies, whether fixed or volatile, which expel the air, having a less affinity to it than to the martial and absorbent earths. In like manner one of the fixed alkalies, or quick-lime, disuniting the volatile alkali of ammoniacal salts, attracts the acid, and constitutes a new compound. A remarkable difference is perceived on the addition of an acid or an alkali to the acidulæ, as the absorption of the air by the latter prevents any effervescence. The want of solidity by which the saline concretes of the Pouhon water are distinguished, Dr. Brownrigg ascribes in a great measure to the fugitive nature of the air. He concludes this ingenious essay with observing, that the uses of fixed air in medicine are extensive and important, inasmuch as it possesses the antiseptic properties of other acids; and by the rarity of its texture, by its power of dissolving calcareous and ferruginous earths, and by its combination with water, it is qualified to act as a deobstruent and a lithontriptic.

Exclusive of the original remarks contained in this paper with respect to the mode of union which takes place between the air and the other principles of the Pouhon water, it affords also indisputable proofs that Dr. Brownrigg was the first who was acquainted with the acid nature of fixed air. Some writers, indeed, of great celebrity, had mentioned certain acids which resembled fixed air; and Pechlinus expressly calls a mephitical expiration in a grotto near the acidulæ at Swalb, in Germany, acid air. To suppose, however, that their vague notions upon the subject amounted to perfect conviction would be to confound conjecture with certainty, probability

with demonstration. Sir Torbern Bergman, of Upsal, who gave to fixed air the name of aerial acid, which was long retained by several eminent chemists, has generally been considered as the first who attempted to explain the various circumstances of its affinity to other acids. But as Dr. Brownrigg's continuation,* though not published till 1774, was written about the same time as his experimental inquiry, viz. about 1765; and as it does not appear that Bergman arrived at a perfect knowledge of the acid properties of fixed air before 1770, the priority of the learned Professor's claim to the discovery can by no means with justice be admitted.

The labours of Dr. Brownrigg in this extensive field of chemistry, which had hitherto been crowned with such surprising success, were afterwards continued with undiminished zeal and perseverance. For many years it was his design to offer to the world an explanation of the causes of some curious phenomena which occurred in his experiments upon the Pouhon water; a description of the different methods of disengaging the air of that water; additional proofs of the dissolving power of fixed air, and of effecting its re-absorption, with illustrations of those doctrines which he had originally advanced. Whether the result of his inquiries had been anticipated by the progressive improvement of science, or for reasons which it would be as difficult as it would be useless to discover, this design was never put in execution; a circumstance which the friends of Dr. Brownrigg, and of mankind, must equally regret.

In the year 1748† Dr. Brownrigg published his valuable work, entitled, *The Art of making common Salt, as now practised in most Parts of the World, with several Improvements in that Art, for the Use of the British Dominions.* He was prompted to undertake this arduous task from a general desire which at that period prevailed in the nation to promote and extend the British fisheries, and by this measure to find a profitable employment, not only for great numbers of seamen, who, on the restoration of peace, had been discharged from the service of their country, but also for the natives of the north of Scotland. The active exertions of the Highlanders during the late rebellion had roused the attention of the Legislature to that remote part of the kingdom, which had hitherto been treated with neglect or indifference. An inquiry into their situation discovered that the inhabitants of a portion of the British empire were sunk into a state of barbarity and ignorance scarcely paralleled in the annals of mankind; and the voice of humanity, as well as of policy, called loudly for the adoption of some expedient calculated to improve and ameliorate their condition, and to introduce amongst them the blessings of civilization.

The establishment of fisheries, for which the north of Scotland is conveniently situated, seemed particularly adapted to facilitate

* See Dr. Brownrigg's letter to Sir John Pringle, prefixed to the continuation.

† It was thought proper to disregard the chronological order of Dr. Brownrigg's publications, for the sake of giving an uninterrupted detail of his discoveries and inquiries relative to fixed and inflammable air.

he accomplishment of so desirable an event. It was naturally expected that a more enlarged intercourse with the world would contribute to enlighten their minds, soften their manners, expand their views, and remove their political prejudices. The nation moreover indulged the hope that such a measure would become a powerful obstacle to future insurrections; that, exciting a spirit of industry, it would have a direct tendency to weaken, if not destroy, the influence of the disaffected chieftains; as it would rescue the vassals from that state of slavish dependence on their masters to which they had hitherto been subjected by their poverty and indolence; whilst the enjoyment of comforts and pleasures before unknown would strengthen their attachment to the existing government. It was justly supposed, also, that could this fishery be conducted with the same skill and success which attended the indefatigable exertions of our continental neighbours on the coasts of Great Britain, the strength and opulence of the state would in consequence be considerably increased.

An inquiry being made by the British Legislature, it was found that salt of a proper quality was wanted in this kingdom for the use of fisheries; and that if salt could be prepared in England of the same purity as in some adjacent countries, the wealth of those who were frequently our enemies would no longer be supported by the money which was expended in purchasing it from them, our fisheries would become more flourishing, and the nation, as well as its colonies, would not on any future occasion be liable to the same difficulties which, from this necessary article of life being the exclusive property of the French, Spaniards, Portuguese, and other foreigners, they had in time of hostilities experienced. In order to remove these inconveniencies, a premium of 10,000*l.* was granted by the House of Commons to Mr. Lowndes, for communicating to the public his method of making brine salt, which he asserted was greatly superior to any salt that could be prepared, either from sea water, or by refining rock salt, and would answer every requisite purpose, being as well adapted for the use of the table as for the preservation of provisions.

Dr. Brownrigg, on examining Mr. Lowndes's publication, though far from depreciating his labours and endeavours, was of opinion that the method proposed was too partial and confined, that it would not fully accomplish the intentions of the Legislature, and that a better, less expensive, and purer salt might be obtained, even from brine, than could be procured according to the plan which that gentleman had recommended. He therefore took a more general and comprehensive view of the subject; and, without soliciting any reward, has given rules for preparing a pure and strong muriatic salt in various ways, as well from sea water and rock salt, as from springs of brine, fit for all culinary uses, and for preventing the putrefaction of animal food.

This publication on the art of making common salt, in which profound and ingenious remarks are united to valuable information,

reflects distinguished lustre on Dr. Brownrigg's talents, whilst his application of philosophical inquiries to the interests and necessities of mankind entitle him to the highest praise and admiration. Having mentioned in the introduction many particulars with respect to the uses, the abundance, and the natural history of common salt; and having laid down a distinction of its different kinds, founded on their origin and mode of preparation, not on those adventitious qualities which result from some heterogeneous admixture, he proceeds in the first place to the consideration of bay salt.

The methods of extracting it, either from the brine of ponds and lakes, or by a total evaporation of the water impregnated with it, and its preparations, as practised in France, Spain, Portugal, the Cape de Verd Islands, Salt Tortuga, and Turk's Island, are explained in a full and satisfactory manner. After an enumeration of the several kinds of white salts, Dr. Brownrigg gives an accurate and comprehensive relation of the processes adopted by various nations for obtaining and preparing them. In describing the artificial mode of procuring salt from sea water by coction, he enters upon an examination of the principles and ingredients of sea water. This analysis, replete with important observations relative to the substances of which it is compounded, their characteristic qualities, their comparative difficulty of separation, and their salutary or deleterious effects upon the human body, has contributed much to the elucidation and improvement of a subject which, though intimately connected with medicine and general science, yet had hitherto been neglected by the experimentalist and the philosopher.

The Dutch method of preparing salt upon salt, which, by the artful policy of that nation, had been carefully concealed from the inquisitive eye of the curious or the interested, was first communicated to the public by Dr. Brownrigg. In consequence of the superior excellency of this refined salt in the preservation of provisions, the Dutch had gained such advantages over their competitors in the herring fishery, as to preclude all expectations of adequate success; and the Doctor, therefore, has an indisputable right to the thanks and praises of his country for the removal of an obstacle which had retarded the prosecution, and even threatened the existence, of that trade. Unrestrained by obligations of secrecy, and convinced that such a discovery would be productive of the most beneficial consequences to the nation, he discloses without reserve whatever information, deserving of credit, he had an opportunity of collecting upon the subject during his residence in Holland. The Dutch refined salt is white salt boiled from a solution of bay salt in sea water, or any other kind of salt water. The only essential difference of the process consists in the addition of half a pint of whey, kept for a considerable space of time, until it has acquired a very powerful degree of acidity. The addition is made on the first appearance of granulation; and to this single circumstance, as the grand arcanum of their art, the Dutch attribute the superior purity, strength, and durability, of their salt.

To this history of the various kinds of bay and white salt are annexed some useful remarks concerning their respective advantages, and the peculiar qualities which they derive from their different mode of preparation. The several methods also of preserving provisions, whether designed for immediate consumption or for exportation, and the properties of that species of salt which is best calculated to resist putrefaction, are enumerated and explained. Without exaggeration, it may be observed that this part of the work claims to itself no inconsiderable degree of credit and praise for a strict conformity to truth, and a faithful adherence to facts, for accuracy of detail, and perspicuity of language. And as it exhibits in a conspicuous point of view the author's versatility of talents, and just discrimination of evidence, his extensive reading, and intimate acquaintance with the manners and customs of various nations, so the remainder of it is eminently distinguished for ingenuity of sentiment, originality of observation, and solidity of judgment.

Sincerely regretting, from disinterested and patriotic views, that the art of preparing salt had not arrived at that degree of perfection in the British dominions as in other countries, and impressed with a conviction that this circumstance was not to be ascribed to any local disadvantage, but solely to the ignorance and unskilfulness of the manufacturers, Dr. Brownrigg proceeds to show that active, laborious, and well-directed exertions, assisted by parliamentary encouragement, would introduce the most important improvements in the preparation of this useful article; and that supplies of it might be obtained, at a moderate price, from the British salterns, in quantity sufficient for our domestic consumption, and in quality even superior to any foreign salt. This opinion he supports, as well by authentic and incontrovertible facts, as by irrefragable and unsophisticated reasoning. Previous to the explanation of his own processes, Dr. Brownrigg, in four lemmas, constituting in a great measure the foundation of the future superstructure, determines with accuracy the annual quantity of rain which falls in different counties of the kingdom, and gives a comparative estimate of the proportion of water ascending from the sea and lakes in exhalations, and descending in rain. The improvements proposed in the art of making bay salt are described and recommended in six propositions.

1. From exact calculations, it appears that during the hottest months of the year the usual evaporation from a pond whose watery particles are exposed to the action of the sun and winds exceeds by 17 inches' depth of water the quantity which it receives by rain. By parity of reason, therefore, a pond filled with sea water to the depth of 16 inches in May, will by the end of August, in consequence of the exhalation arising from it, contain nothing but a crust of salt deposited at its bottom, which crust is determined, by proper calculations, to be equal to 1245 bush. 64 lb. upon a statute acre. As this method is tedious, and liable to many inconveniences; as its success depends on the casualties of the

and the vicissitudes of the weather; and more particularly as the salt, from its thickness, being only about $\frac{1}{4}$ of an inch, must be injured by an unavoidable mixture of mud, calcareous earth, and other impurities adhering to it, in a very large proportion, its actual practice is not recommended.

Dr. Brownrigg endeavours to demonstrate, in the second proposition, that the preparation of bay salt in England may be conducted with equal convenience, expedition, and certainty of success, as in France, Spain, and Italy; and that the sea coast, from Dover to Yarmouth, is well adapted to this purpose. He thinks that as the French can prepare, in a fortnight of favourable weather, a supply of salt adequate to their annual consumption, and that of their commercial allies; so it would be by no means impracticable to obtain here, in the course of the summer, considerable quantities by the method which they have adopted. In the latitude, in the climate, in the temperature of the atmosphere, in the operation of the winds, in the frequency or quantity of rain, and in the accidental circumstances which may retard and interrupt the process, no remarkable or material difference can be discovered at some parts of the French and English coasts. Even on the supposition that in the former country a double quantity of water would evaporate in equal spaces of time, in consequence of a more intense heat, yet Dr. Brownrigg conceives that this inconvenience might be obviated in such a manner as that the French manufacturers of salt should possess no advantage over our own, either in the quantity prepared, or in the inferiority of its price. The introduction in this place of his ingenious arguments and accurate calculations is incompatible with the nature and design of the present work: the inference, however, which naturally arises from them, is, that a greater extent of surface must be exposed at an English salt-marsh to the influence of the sun and air, which extent must be determined and regulated by the proportion of the sun's heat in England to that in France. The English salt-pit will also require a more enlarged surface, on account of the rain received into it during evaporation. The exact extent it must be obvious can only be ascertained by suitable and repeated experiments. From a due consideration, however, of every circumstance, the following conclusion appears reasonable: that an equal quantity of salt may be obtained from an English as from a French salt-pond, when the surface of the former exceeds that of the latter by one-fifth part. Although the practicability and convenience of this method must be admitted, yet it is attended with these disadvantages, that it is liable to interruption from rain, that the preparation of any considerable quantity is prevented, and that the formation of large crystals cannot be effected. The plan, therefore, explained in the third proposition, is deserving of preference. It consists of improvements in the construction of the French salt-marsh; the object of which is to prevent the dilution of the brine with rain, to add force to the heat of the sun, and to accelerate the exhalation of

the water. Dr. Brownrigg recommends certain covers of thin board, or of coarse canvas stretched on frames of wood, as useful on two accounts: first, when hanging down, as a protection for the ponds from rain; and, secondly, when erected, as reflectors of the sun's rays. He also thinks it advisable to raise the salt water by the assistance of a small fire-engine, which must be suffered to return into the reservoir by means of a diverger, as the evaporation will thus be increased, and consequently completed in a much shorter space of time. By these contrivances, and some others which are described, he apprehends that at an English work of equal size and dimensions with one in France a double quantity of salt might be procured.

The fourth proposition relates to the preparation of bay salt from the natural brine of salt springs, and also from rock salt dissolved in sea water or weak brine. In those places where natural brine is perfectly saturated with salt, no further process is requisite for obtaining it, except the separation of its impurities; and a complete impregnation of weak brine with salt may be produced by exposure to the action of the sun and air, increased by reflectors. Large quantities of bay salt may also be procured, either from weak brine, or sea water saturated with rock salt. From exact calculations, Dr. Brownrigg concludes that, on the most moderate computation, 18 pits of three inches depth, and 16 feet square, filled with brine completely saturated, will contain more than 21177 lb. of salt, and that the time requisite for its preparation may be estimated at six days.

He next proceeds, in the fifth proposition, to an examination of the quality and quantity of the salt obtained by the above-mentioned processes, and of the expenses connected with its preparation. He first proves that, notwithstanding the acknowledged superiority of the French bay salt, its price is only one-third of that for which white salt can be prepared in those parts of England which are most favoured by nature, and improved by art. He next shows that the expenses of making a salt-marsh in England, after the French construction, would not much exceed those incurred by the French manufacturers, and that the additional expenses occasioned by the improvements described under the third proposition would be amply compensated by more than a proportional increase of profit. If, however, any difference in the price of English salt should exist, this disadvantage would be sufficiently counterbalanced by its exemption from certain duties and customs imposed upon salt imported from France, and by certain indulgences and encouragements afforded by the Legislature to British manufacturers. From the nature of the processes recommended, and from actual experience, he thinks himself justified in concluding that the British salt would be by no means inferior in its qualities and uses to that of foreign preparation; suggesting, at the same time, a method for a more perfect purification of the brine.

Under the sixth proposition he considers the practicability of obtaining in North America, from sea water, a supply of bay salt adequate to its consumption. From the comparative situation of France and North America; from the natural and artificial advantages of the latter, from the intensity of its heat, from the early maturity of its fruits; from all these considerations the necessary inference, as he conceives, is, that by inconsiderable exertions, and at a moderate expense, the inhabitants of that portion of the globe might prepare salt in such abundance, as not only to satisfy the demand of their fisheries, but even render their commerce more flourishing by its exportation.

(To be continued.)

ARTICLE II.

Explanation of the Characteristics d and δ. By Mr. Adams.

(To Dr. Thomson.)

SIR,

Stonhouse, near Plymouth, July 6, 1817.

BEING of opinion that the following explanation of the characteristics *d* and *δ*, together with the general formula derived therefrom, may be useful to youths just entering upon the differential and integral calculus, your inserting them in the *Annals of Philosophy* will much oblige,

Sir, your most obedient servant,

JAMES ADAMS.

On the Characteristics d and δ.

Since by differentiating with the characteristic *d*, we have

$$d(x) = d x$$

$$d(x^2) = 2 x d x$$

$$d(x^3) = 3 x^2 d x$$

.....

$$d(x^n) = n x^{n-1} d x$$

$$d^2(x^n) = n(n-1) x^{n-2} d x^2$$

&c. &c. *d x* being constant.

So by differentiating with the characteristic *δ*, we have

$$\delta(x) = \delta x = \frac{d x}{d x} \cdot \delta x$$

$$\delta(x^2) = 2 x \delta x = \frac{2 x \delta x d x}{d x} = \frac{d x^2}{d x} \cdot \delta x$$

The Same from the Consideration of Curves.

Let $A M$, $B N$, be any two curves; and $P M$, $R r$, two consecutive ordinates; the other lines as per figure.

Put $R v = y$, then $v r = \delta y =$ variation of the ordinate $R v$, and $N n =$ differential of the same ordinate.

In like manner, $M N$ will represent the variation of $P N$, and $M m$ the differential of $R r$.

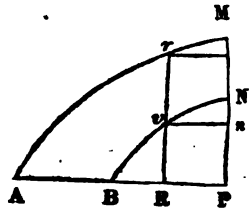

Hence $v r + M m = M N + N n$; that is,
 $\delta y + d(y + \delta y) = \delta(y + d y) + d y$; or,
 $\delta y + d y + d \delta y = \delta y + \delta d y + d y \therefore d \delta y = \delta d y$.

COROLLARY

In any two curves. The difference of the variations of two consecutive ordinates is equal to the difference of their differentials.

For $v r + M m = M N + N n \therefore v r - M N = M m - N n$.

The expression $\int \delta V = \delta \int V$, may be proved as follows:—

Let $w = \int V = n^{\text{th}}$ integral of V .

Then $d^n w = V \therefore \delta d^n V = \delta V = d^n \delta w$ (by the foregoing)

Therefore $\int \delta V = \int d^n \delta w = d^{n-1} \delta w = \delta w = \delta \int V$

That is, $\int \delta V = \delta \int V$ (B).

Suppose ϕ and θ to represent two variable functions; and let it be required to find the variation of $\int \phi d^n \theta$. From the theorems marked (A) and (B), we have $\delta (\int \phi d^n \theta) = \int \delta (\phi d^n \theta) = \int (\phi \delta d^n \theta + \delta \phi d^n \theta)$,

And $d^n (\phi \delta \theta) = \phi d^n \delta \theta + d^n \phi \delta \theta = \phi \delta d^n \theta + d^n \phi \delta \theta$,

Therefore, $\phi \delta d^n \theta = d^n (\phi \delta \theta) - d^n \phi \delta \theta$.

Then, by substitution,

$$\delta (\int \phi d^n \theta) = \int \{ d^n (\phi \delta \theta) - d^n \phi \delta \theta + \delta \phi d^n \theta \}$$

$$= \int \phi \delta d^n \theta + \int (\delta \phi d^n \theta - d^n \phi \delta \theta).$$

If $m = n = 1$, then

$$\delta (\int \phi d \theta) = \phi \delta \theta + \int (\delta \phi d \theta - d \phi \delta \theta).$$

ARTICLE III.

Solution of the Equation $\psi^2 x = x$. By Mr. Horner.

THE general method of effecting this solution when a particular value f of ψ is known, has been given by Mr. Babbage in his *Essay on the Calculus of Functions*. (Phil. Trans. 1815.) He has favoured us with some additional illustrations of the subject in the second volume of the *Journal of Science*; where he has employed a very ingenious artifice to solve the particular cases $\psi^2 x = x$, and $\psi^4 x = x$.

The solution of the general equation on the same principle would have led Mr. B. into details inconsistent perhaps with the breadth of plan which the development of a new calculus requires; and which he might have felt himself the less disposed to pursue, in consequence of thinking it "probable that this solution, although a very extensive one, does not contain all the possible answers; and if we have regard to the utmost generality, the solution [of $\psi^4 \vartheta = \vartheta$] must be deduced from that of the equation

$$F \{ \vartheta, \psi \vartheta, \psi^2 \vartheta, \psi^3 \vartheta \} = 0."$$

I cite these words from Mr. B.'s concluding observations, in the *Journal* just mentioned, on the solution of $\psi^4 x = x$, which is contained in the formula

$$\psi x = \phi^{-1} \left\{ \frac{a + b \phi x}{c - \frac{b^2 + c^2}{2a} \phi x} \right\}$$

And, with all the deference due to this gentleman's profound science, I cannot help attributing his hesitancy in this instance to his having overlooked a principle which he has so happily applied to functions of the first order in Prob. VIII. of his *Essay*. It is by no means restricted to such expressions, but adapts itself with the evidence of an axiom to *pure* functional equations of *all orders*. I refer to the principle that the arbitrary constants in such equations may be exchanged for any symmetrical functions of *all* the inferior functions of the variable concerned. In the formula just quoted, for example, we are at liberty to make

$$a = \bar{\alpha} \{x, \psi x, \psi^2 x, \psi^3 x\}$$

$$b = \bar{\beta} \{x, \psi x, \psi^2 x, \psi^3 x\}$$

$$c = \bar{\gamma} \{x, \psi x, \psi^2 x, \psi^3 x\}$$

And when these substitutions are made, nothing—as it appears to me—can be added to the generality of the solution.

By this method, it is true, we arrive frequently at *implicit func-*

tions; but this circumstance does not detract from the perfection of the solution, since the results are placed within the reach of known processes.

The proof and illustration of these remarks will be attended with no difficulty, as far as they regard the simple case

$$\psi^2 x = x,$$

whose solution is

$$y = \psi x = \phi^{-1} \left(\frac{a - b \phi x}{b + c \phi x} \right).$$

In fact, by taking ϕ on both sides, and reducing, we obtain

$$b \phi x + c \phi x \phi y + b \phi y = a$$

a symmetrical function of x and y , which can be readily identified, by means of the arbitrary constants, with any proposed function similar to

$$\bar{F} \{x, y\} = 0,$$

and, therefore, *a fortiori*, with any particular solution of the case.

EXPER. I.—When $a = b = 1$, $c = 0$, and $\phi x = x^2$, we have

$$y = \psi x = \sqrt{1 - x^2}$$

EXPER. II.—When $b = 4$, $c = \frac{4e}{xy}$, and $\phi x = x^2$, a and e remaining arbitrary, the functional solution is

$$y = \psi x = \sqrt{\frac{a - 4x^2}{4 - \frac{4ex}{y}}}$$

of which again the algebraic reduction produces

$$y = \frac{1}{2} \{ex + \sqrt{a + (e^2 - 4)x^2}\}$$

I have selected these examples, because their final results are the only ones given by Mr. B. whose identity with the general formula is not self-evident.

Satisfied with a high degree of probability that a similar solution will be also universal in regard of the superior orders, I shall proceed to the general equation

$$\psi^n x = x.$$

Mr. B. has remarked, that if $f x = \frac{a + b x}{c + d x}$, $f^n x$ will be = $\frac{A + B x}{C + D x}$, where A, B, C, D , are given functions of a, b, c, d ;

“and these latter quantities may always be so assumed, that $A = 0$, $B = C$, and $D = 0$.” Nothing more appears to have been intended by the last observation than what is evident from the elementary principles of elimination, that because we know the values of four independent functions of a, b, c, d , we can determine the values of these quantities. But in entering into the calculations, we discover the curious fact, that the conditions here recited

are coincident; so that wherever one exists, the others also exist necessarily. The establishing of this proposition leads directly to the general solution we are seeking.

$$\text{If } f x = \frac{a + b x}{c + d x}, f^2 x = \frac{a_2 + b_2 x}{c_2 + d_2 x}, f^3 x = \frac{a_3 + b_3 x}{c_3 + d_3 x}$$

&c. we shall have, in the second function,

$$\begin{aligned} a_2 &= a b + a c = (\text{say to}) a s_2 \\ b_2 &= a d + b^2 = b s_2 + a d - b c \\ c_2 &= a d + c^2 = c s_2 + a d - b c \\ d_2 &= b d + c d = d s_2 \end{aligned}$$

giving obviously

$$\frac{a_2}{a} = \frac{b_2 - c_2}{b - c} = \frac{d_2}{d} = s_2$$

and consequently

$$b_2 + c s_2 = b s_2 + c_2 = (\text{say to}) s_2$$

The next transformations give

$$\begin{aligned} a_3 &= a_2 b + a c_2 = a b s_2 + a c_2 = a s_3 \\ b_3 &= b b_2 + a d_2 = b b_2 + a d s_2 = b s_3 + (a d - b c) s_2 \\ c_3 &= c c_2 + a d_2 = c c_2 + a d s_2 = c s_3 + (a d - b c) s_2 \\ d_3 &= b_2 d + c d_2 = b_2 d + c d s_2 = d s_3 \end{aligned}$$

where also

$$\frac{a_3}{a} = \frac{b_3 - c_3}{b - c} = \frac{d_3}{d} = s_3$$

And as this second series of equations expresses the general law of successive derivation, it follows that this condition of the coefficients is universal, viz.

$$\frac{A}{a} = \frac{B - C}{b - c} = \frac{D}{d} = S.$$

Now the function A disappears when $a S = 0$, a condition which cannot in this instance be satisfied by making $a = 0$; for, if $a = 0$, then $a_2 = 0$, $a_3 = 0$, &c. as is manifest from their derivation; that is, the quantity generally expressed by A does not disappear, but has never existed. Nothing, therefore, is effected on the assumption of $a = 0$, which would not inclusively be done by making $S = 0$. The same remarks precisely apply to the other quantities. Make then $S = 0$, and we have $A = B - C = D = 0$, simultaneously. Q. E. D.

It follows as a corollary, that the solution of $f^n x = x$ is deduced from the solution of $s_n = 0$. To accomplish which, attention must be paid to the successive development of S ; which I subjoin, designating, for the sake of convenience, $b + c = s_2$ by s simply, and $a d - b c$ by x :

$$\begin{aligned}
 s_1 &= b_1 + c = \dots\dots\dots s^0 + x \\
 s_2 &= b_2 + c s_1 = \dots\dots\dots s^2 + 2s x \\
 s_3 &= b_3 + c s_2 = s s_2 + s_2 x = s^3 + 3s^2 x \\
 s_4 &= b_4 + c s_3 = s s_3 + s_3 x = s^4 + 4s^3 x + 3s^2 x^2 \\
 &\dots\dots\dots \\
 s_n &= s^{n-1} + \overline{n-2} s^{n-3} x + \frac{n-3 \cdot n-4}{1 \cdot 2} s^{n-4} x^2 + \frac{n-4 \cdot n-5}{1 \cdot 2 \cdot 3} \\
 & s^{n-5} x^3 + \&c.
 \end{aligned}$$

This equation readily identifies itself with a well-known formula connected with multiple arcs. In fact, if we make

$$z = \frac{-s^2}{4 \cos^2 \vartheta} = \frac{-s^2}{2 + 2 \cos 2\vartheta},$$

we shall have

$$s_n = \frac{s^{n-1} \times \sin n\vartheta}{\sin \vartheta \times (2 \cos \vartheta)^{n-1}},$$

a function which becomes null when $\vartheta = \frac{k\pi}{n}$, k being any integer.

The connexion in which it appears will show that k in the subsequent formulæ must be interpreted 1, 2, 3, ..., $\frac{1}{2}n - 1$, or $\frac{1}{2}(n - 1)$, as n is even or odd. In other words, $k < \frac{1}{2}n$.

Restoring then the values of s, x, ϑ , our investigation gives

$$ad - bc = \frac{-(b+c)^2}{2 + 2 \cos \frac{2k\pi}{n}}$$

and consequently

$$d = \frac{-(b^2 - 2 \cos \frac{2k\pi}{n} bc + c^2)}{(2 + 2 \cos \frac{2k\pi}{n}) a}$$

If this be substituted for d in the value of $f x$, the equation $f^n x = x$ is solved; and as Mr. Babbage has shown (Essay, Prob. XI.) that $\psi^n x$ will be $= \varphi^{-1} f^n \varphi x$, if $\psi x = \varphi^{-1} f \varphi x$, the general solution of $\psi^n x = x$ is

$$\psi x = \varphi^{-1} \left\{ \frac{a + b \varphi x}{b^2 - 2 \cos \frac{2k\pi}{n} bc + c^2} \right. \\
 \left. c - \frac{(2 + 2 \cos \frac{2k\pi}{n}) a}{(2 + 2 \cos \frac{2k\pi}{n}) a} \cdot \varphi x \right\}$$

which becomes universal, by assigning to the arbitrary coefficients the values

$$\begin{aligned}
 a &= \bar{\alpha} (x, \psi x, \psi^2 x \dots \dots \psi^{n-1} x) \\
 b &= \bar{\beta} (x, \psi x, \psi^2 x \dots \dots \psi^{n-1} x) \\
 c &= \bar{\gamma} (x, \psi x, \psi^2 x \dots \dots \psi^{n-1} x)
 \end{aligned}$$

as I showed in the beginning of this paper.

In adapting this result to particular cases, it must be considered that if $\psi^n = x$, then is $\psi^m = x$; and of consequence, when $s_m = 0$, $s_n = 0$. Whenever, therefore, n is not a prime number, we must separate from the solution of $s_n = 0$ such roots as have been anticipated by previous equations. The legitimate roots of the n^{th} function are those in which n and k are incommensurate.

An important advantage, peculiar to this form of solution, consists in the facility of finding the inverse functions. Thus, in the general formula

$$\psi^n x = \phi^{-1} \left(\frac{a_n + b_n \phi x}{c_n - d_n \phi x} \right)$$

substitute $\psi^{-n} x$ instead of x , and we obtain

$$x = \phi^{-1} \left(\frac{a_n + b_n \phi \psi^{-n} x}{c_n - d_n \phi \psi^{-n} x} \right)$$

take ϕ on both sides, reduce the equation, and resume ϕ^{-1} , the result is

$$\psi^{-n} x = \phi^{-1} \frac{c_n \phi x - a_n}{d_n \phi x + b_n}$$

Having no design of trespassing on the manorial rights of Mr. B. I have solely indulged myself in the liberty of pursuing a little in detail one or two of his general ideas. A few words more, by way of partial elucidation of the uses which may be made of these inverse functions, shall close these remarks, which I fear are already becoming tedious. In the Journal of Science (*loc. cit.* Prob. III.), Mr. B. has considered that case of reversion of series in which both series agree in regard of the signs as well as the coefficients, and has shown this phenomenon to be "nothing else than a different mode of denoting the general solution of $\psi^2 x = x$."

The connexion between this case and those in which the two series differ in regard of the alternate signs will appear more clearly by regarding them as solutions of the equations

$$\begin{aligned} \psi^{-1} x &= \psi x = y \\ \psi^{-1} x &= -\psi(-x) = y \\ \psi^{-1} x &= \frac{1}{\sqrt{-1}} \psi(x \sqrt{-1}) = y \end{aligned}$$

which, it may be noticed, are only particular cases of the equation

$$\psi \chi x = x = \psi y,$$

supposing χ related to ψ as ψ was to f .

If the values of the equated functions be taken from the formula previously exhibited, the general solutions of the first two cases will be

$$\psi x = \phi^{-1} \left(\frac{a - b \phi x}{b - c \phi x} \right)$$

when the direct and reverted series agree both in signs and coefficients, and

$$\psi x = \phi^{-1} \left(\frac{a + b \phi x}{b - c \phi x} \right)$$

when they differ only in the coefficients of the even powers.

The third case has only the odd powers of x and y , and the alternate signs in the two series are different. To be generalized, it requires that a particular solution should be known. Such a solution is

$$x = \psi x = \log. \tan. \left(\frac{\pi}{4} + \frac{1}{2} x \right) = \log. \frac{1 + \tan. \frac{1}{2} x}{1 - \tan. \frac{1}{2} x}$$

which gives, when reverted,

$$y = \frac{1}{\sqrt{-1}} \log. \tan. \left(\frac{\pi}{4} + \frac{1}{2} x \sqrt{-1} \right) = \&c.$$

This has been supposed to be the only pair of sines possessing the remarkable property described, but on the principle so often already referred to, we shall have in general

$$x = \phi^{-1} \log. \tan. \left(\frac{\pi}{4} + \frac{1}{2} \phi^x \right);$$

for example, if $\phi y = E^y$, we shall have

$$x = \log.^2 \tan. \left(\frac{\pi}{4} + \frac{1}{2} E^y \right)$$

which will have the same property.

Postscript.—The functions α and β , which are introduced to give the second degree of generalization, were known to Mr. Babbage, as appears from the concluding pages of his *Essay*, and particularly from the proposition contained in the last two lines of p. 422 and the first two of p. 423.

ARTICLE IV.

Of Cinnamon as an Article of Commerce. By H. Marshall, Esq.
Staff Surgeon to the Forces in Ceylon.

THE earliest notice we have of cinnamon is in Exod. xxx. 23. It is again mentioned in the Song of Solomon, iv. 14; and in Prov. vii. 17. Casia a synonyme of cinnamon is mentioned in Esek. xxvii. 19, where it is enumerated among a large variety of articles of merchandise.* As the ancients were supplied with cinnamon from Arabia, and the north and east coast of Africa, they, without

* Sweet cane is mentioned in two places of Scripture (Isaiah, xliii. 24, and Jeremiah, vi. 24). Is cinnamon the substance intended to be designated by the appellation sweet cane? In both places it evidently means something used in sacrifice. Cinnamon was used for this purpose. It is not probable that sweet cane means sugar-cane, as sugar is not mentioned in the Old Testament, and was not used in the religious ceremonies of the Mosaic dispensation. In the first passage where it is mentioned, it is said, thou hast not bought me sweet cane with money; and in the other it is spoken of as coming from a far country; both passages imply an article of merchandise or importation, not of native growth. Now we have good authority for believing that the sugar-cane is indigenous in Palestine, Syria, and Arabia, or was introduced into those countries in the earliest ages. The crusaders found the sugar-cane in great abundance in Syria, which they called *canna melis* (honeyed reeds).

good foundation, supposed that this spice was the produce of those countries.* There is much probability that from the earliest ages Europe has been indebted to Ceylon for part of its consumption of this article. It may have been exported from Ceylon by small vessels belonging to the island, or to the natives of the continent of India, to some of the emporia on the Malabar coast, and from thence to Sabea, on the south coast of Arabia, by the Arabs, who were the first who traded extensively on the Indian Ocean. Here the ships belonging to the merchants of Phœnicia and Egypt found large stores of the produce of India; and by this medium the demands from all parts of Europe were supplied. Even in modern times the commodities of India were chiefly imported into Europe by the way of Egypt. The enormous expense incurred by transporting cinnamon such a circuitous route, and a great part of it by land, must have greatly enhanced its price, and prevented the use of it from becoming general.

On some occasions, however, the quantity expended appears to have been considerable. At the funeral of Sylla 210 burthens of spices were strewed upon the pile. It is probable that cinnamon formed a great part of the spices burned on this occasion, as the produce of the Moluccas was then but little, if at all, known to the Romans. Nero is reported to have burned a quantity of cinnamon and casia at the funeral of Poppæa greater than the countries from which it was imported produced in one year.

In 1498 Vasco de Gama landed at Calicut. Indian commerce now took a different route, and the Portuguese supplied Europe with the articles which had formerly passed through the hands of the Venetians. Eager to engross the cinnamon trade, the Portuguese, early in the 16th century, arrived at Ceylon, and obtained leave from one of the chiefs to establish a factory, which led to the erection of the Fort of Colombo. Notwithstanding the permission of the chief, their landing was obstinately opposed by the Arab merchants, who had for many ages supplied Europe with cinnamon, and who dreaded an immediate termination of their monopoly. Shortly after a fort had been built, the Portuguese succeeded in concluding a treaty with the King of Kandy, wherein he agreed to furnish them annually with 124,000 lb. of cinnamon: on the part of the Portuguese, it was stipulated that they were to assist the King and his successors, both by sea and land, against all his enemies.

The thriving and rich settlements of the Portuguese in the East Indies eventually attracted the attention of the adventurous and opulent merchants of the States of Holland. Soon after they had gained some footing in India, they became anxious to engross the

* Bruce informs us that casia grows spontaneously in that strip of ground from the bay of Belus west of Azab, east to Cape Gardesfan, and then southward up the Indian Ocean to near the coast of Melinda, where there is cinnamon, but of an inferior quality; but we have no undoubted authority for believing that cinnamon was ever prepared in Africa, and exported as an article of commerce.

cinnamon trade, which, as Baldeus emphatically observes, is "the Helen or bride in contest of Ceylon;" and early in the 17th century found means to ingratiate themselves with the King of Kandy, who invited them to aid him to expel the Portuguese from the island.

In 1612 the King engaged to deliver to the Dutch East India Company all the cinnamon that he was able to collect.

In 1638 the garrison of Batticaloa was captured by the combined Dutch and Kandian forces. On this occasion a treaty was concluded between the King and the Dutch General, wherein it was stipulated that none of the King's subjects were to be permitted to sell the Dutch any cinnamon, &c. &c. except what was sold by his order. He retained the entire and exclusive privilege of preparing and selling this article of commerce.

Peace was concluded between the Portuguese and Dutch in 1644 or 1645. By this treaty a moiety of the cinnamon trade was ceded to the Dutch. The cinnamon was collected in the following manner:—Both parties employed chalias to cut and prepare cinnamon, which was to be deposited in a convenient spot upon the river Dandegam, near to Negombo. At the end of the cinnamon harvest, the quantity collected was equally divided between the two parties; and each party paid the usual price to the chalias for peeling their share of cinnamon. War again commenced in 1652. Colombo surrendered to the Dutch in 1656; and Jaffna, the last place of strength of the Portuguese, fell in 1658.

For many years previously to the entire surrender of Ceylon by the Portuguese, the Dutch had purchased and exported large investments of cinnamon from the Malabar coast. To obtain the exclusive commerce of this coast, they, in the year 1662 and 1663, wrested from the Portuguese the forts of Quilon, Cannanore, Cochin, and Cranganore.

The English merchants were desired to withdraw from this coast; and the natives were prohibited from supplying the English with produce under penalty of confiscation. The Dutch exerted all their influence and power to obstruct the peeling of cinnamon in the territories of the Malabar princes, except what was sold to themselves, for which they refused to advance the regular market price.

Notwithstanding a zealous perseverance, and a rigid exertion of their power, to prevent what they denominated smuggling on this coast, they did not succeed. Other nations, by paying nearly double for the articles they purchased, were readily supplied by the natives, even in opposition to the orders of their own princes. These fruitless attempts are stated to have been very expensive; which induced the Supreme Government to pass in 1697 a number of regulations. One of these regulations stated, "that it was determined not to obstruct any more, by measures of constraint and harshness, the navigation of the Malabars, and their trade in the

productions of their country, consisting chiefly in areca, wild cinnamon, and pepper, which the Company could not exclusively purchase from them."

In 1687 the Dutch imported into Holland cinnamon to the amount of 170,000 lb. This quantity is stated to have been less than the usual annual importation.

In 1730 they imported 640,000 lb.

The Dutch continued to enjoy the exclusive commerce of this spice for many years. The means adopted for this end were well imagined, but not so correctly carried into effect. The correspondence between the Directors and the Supreme Government evince the care that was taken to "direct and command that no cinnamon should be exported but what was of an excellent quality." The Directors complain repeatedly that much of the cinnamon imported from Ceylon was of a bad quality. They enumerated the defects, and stated, in their letter bearing date September, 1768, that for several years it had been of such a bad quality that they had not dared to bring it to the sales, for fear of ruining the credit of the Ceylon cinnamon. On several occasions they returned a number of bales of "bad, ill-sorted cinnamon," that the Ceylon Government might institute an inquiry respecting the causes why their commands were so much neglected. They complain much of the inspectors of cinnamon; and add, that they must either be very deficient in a knowledge of their duty, or extremely negligent. According to oral information, the chief cause of defective cinnamon having been exported was, that the requisitions from Holland were always for a larger quantity than they were able to procure of an excellent quality.

Before the Kandian war, which terminated in 1766, the Dutch annually exported from Ceylon from 8,000 to 10,000 bales of cinnamon, each weighing 86 lb. Dutch, or about $92\frac{1}{2}$ English. This war, which was very unfortunate for the King of Kandy, was extremely expensive to the Dutch. The chief advantage they obtained was the entire possession of the harbours and coasts round the island. By the treaty of peace agreed upon on this occasion it was stipulated that the Dutch were to be permitted to bark cinnamon in the King's territory to the westward of the Balany Kandy, which is a range of mountains that stretches nearly north and south, and is about 12 English miles west from Kandy. It was also stipulated that the King was to receive five pagodas per bale, or about 5*d.* per lb., for all that which his subjects barked and prepared in his country to the eastward of Balany Kandy. The cinnamon collected by the Dutch was estimated to cost them about this price. The cinnamon furnished, in consequence of this treaty, by the subjects of the King of Kandy, was of an inferior quality, being mixed with thick, coarse, and ill-prepared bark.

The Dutch accepted only of what they deemed of a good quality, and paid for the quantity they received. The Kandians considered this an unprofitable speculation, and soon ceased to furnish cinnam-

mon of any quality. Posterior to the war of 1766 Ceylon did not export annually more than from 6,000 to 7,000 bales of cinnamon. This defalcation has been ascribed to the discouraging conduct of the King. It was not to be expected that he should have entered cordially into a measure to which he had been forced to yield a reluctant acquiescence. So unwilling was the King of Kandy to extend the limits for cutting cinnamon, that he on one occasion refused 5,000 pagodas which were offered to him by the Dutch for permission to peel cinnamon for five months in a district to the eastward of Balany.

Stavorinus, who visited the Malabar coast in the years 1775 and 1778, says that an annual quantity of 1,000,000 lb. of cinnamon is said to be exported from this coast to the Gulf of Persia and to the Red Sea. A small quantity is likewise sent to Europe. This quantity is incredible.

Fra Paolino da San Bartolomeo had, from his long residence, profession, and studies, an infinitely better opportunity of learning the internal state of the country, as well as the export trade, than Stavorinus, who was only an occasional visiter. He arrived in India in 1776, where he resided 13 years. He tells us that the English purchased cinnamon from the King of Travancore, at the rate of about 80 rupees a candy, or about 500 lb. Avoirdupois, which is nearly two fans per lb., and that Malabar supplied at least 500 candys, amounting to 250,000 lb. He adds, that "the Dutch do not wish the cinnamon to thrive, and extirpate the trees in Malabar wherever they find them, in order that their cinnamon which grows on Ceylon may not become of less value." The statements of the learned Carmelite appear in general to deserve belief, except relating to the subject of religion, and then his opinions and conduct seem to be at variance with his usual good sense.

Mr. Wilcocke, the translator of the *Voyages of Stavorinus*, in his note to the work, says, that in 1778, 600,000 lb. of cinnamon were disposed of at the Europe sale, at about 1*1*s. sterling per lb., being part of the imports from Ceylon. In an appendix to that work, he gives a statement of the quantities of cinnamon and cinnamon oil sold at the Dutch East India Company's sales from 1775 to 1779:—

Pounds of cinnamon in 1775, 400,000—1776, 400,000—1777, 400,000—1778, 350,000—1779, 300,000.

Ounces of oil of cinnamon, in 1775, 240—1776, 160—1777, 60—1778, 160—1779, 160.

Being an annual average of 370,000 lb., which, if sold at 1*1*s. per lb., the rate stated above for the year 1778, amounts to 203,500*l*.

The encroachments of other nations into the cinnamon trade continued to give the Dutch great alarm. These encroachments, which were never regarded with indifference, had been making gradual, but steady, advances. A letter from the Dutch India *Directors*, addressed to the Supreme Government, bearing date

Dec. 29, 1787, expressly states, that "We have great need of a considerable quantity of the best cinnamon to put a stop to the consumption of the Chinese, and the cinnamon imported by other nations; and by that circumstance, to occasion their not yielding a profit any longer, prevent their importation; and by these means ours will retain that general estimation which alone can ensure its high price, and consequently our profit." Their fears were too well grounded: the cinnamon importations into Holland gradually declined.

The following is an account of the cinnamon imported and sold at the Dutch India Company's sales from the years 1785 to 1791 inclusive, with the sale amount of each year:—

Years.	lb.	£.
1785	309,040	199,470
1786	453,920	280,605
1787	144,000	82,470
1788	485,600	273,765
1789	463,400	252,785
1790	375,920	205,045
1791	183,765	100,235

The average quantity imported into Holland in each year of the preceding period is 345,092 lb., and the average annual amount 199,195*l.* 8*s.* being about 11*s.* 6*d.* per lb.

This statement evinces that the exportation of cinnamon was on the decline: it still, however, retained its price. The rivalry of the China cinnamon trade, and the difficulties and impediments occasioned by the King of Kandy to the collecting of cinnamon in his territories, may be assigned as the chief causes of the diminution of the cinnamon commerce in Ceylon. The Kandian Court, although unsuccessful in the resistance it made against the Dutch, remained unconquered, and entertained a proud spirit of independence, a constant enmity, and deep resentment, against its invaders, for the many attempts they had made to humiliate and subdue its power. The misfortunes of both parties occasionally led to a cessation of hostilities, sometimes to mutual concessions, but never to amity.

To check the rivalry of the Chinese cinnamon, and to render themselves independent of the King of Kandy, the Dutch adopted means which experience has evinced to have been extremely prudent.

The plan they adopted was the cultivation of cinnamon in their own country. Cinnamon began to be cultivated in very small quantity on Ceylon about the year 1765; the propriety and necessity of the measure became more evident; and succeeding circumstances rendered it more and more imperious to extend the cultivation by all the means of which they were in possession. Dr. Thunberg, who visited Ceylon in 1778, informs us, that "by the unremitting exertions of Governor Falck, exceedingly large plantations

of cinnamon had been formed, and that the shoots of some of the plantations had been already three times barked." He particularly mentions large plantations of cinnamon being cultivated at Sitawake, a place situated near to the Kandian border, and about 30 miles from Colombo, at Grandpass, Marendahu, Matura, and Caltura.

Governor Falck died in February, 1785; and was succeeded in the colonial government by W. J. Vande Graaf, a zealous promoter of the cultivation of cinnamon. He prosecuted Governor Falck's undertaking with zeal, judgment, and perseverance. The district or portion of the belt of territory possessed by the Dutch, which affords good cinnamon, is bounded on the north by the Reymel river, a few miles to the northward of Negombo, and on the east by the river Wallaway, near Hambantotte. Beyond these boundaries few cinnamon plants grow; and their bark, when prepared, is not only deficient in the cinnamon odour and flavour, but sometimes bitterish, and unpleasantly tasted. Between these two rivers, but particularly between Negombo and Matura, many extensive fields were cleared, and planted with cinnamon. This must have been a work of infinite labour.

In Ceylon trees and low brushwood rise with great rapidity, and cover the ground with a dense luxuriance of wood and foliage which is unequalled, except in the richest of the tropical islands. The business appears to have been entered upon with spirit, zealously prosecuted, and conducted with economy.

The labour of clearing and planting the government plantations was performed chiefly by the native Cingalese, as personal service. By exciting a rivalry among the native headmen, liberally feeding their vanity with praise, and sometimes conferring high-sounding titles upon a few of them, and occasionally bestowing upon some of the most active a gold chain, a medal, or a silver hilted hanger, the labour seems to have, on their part, been executed with some degree of alacrity. Permanent situations, with a small monthly salary, were given to some of the headmen, who cultivated cinnamon extensively. Many spots of ground were planted, particularly in the Aboet Roer Corle, near to Negombo, by granting lands to the natives, who bound themselves and their heirs to plant one-third of the lands with cinnamon, and to guard the plants from being overgrown with brushwood, or destroyed by cattle. For every pingo (60 lb.) of good cinnamon produced on these plantations the owner was allowed two rix dollars (about 3*s.* 6*d.* sterling). The shoots were cut, and the bark prepared, by the government peelers.

Severe penalties were inflicted upon persons cutting, or otherwise destroying, cinnamon plants. On conviction, the culprit was severely fined, sentenced to hard labour in chains for a period of years, or banished to the Cape of Good Hope for a term of 25 years. These laws are still in force.

Political altercations between the Colonial Government and the *Court of Kandy* occurred in 1782, and also in 1792. During these

altercations the peeling of cinnamon in the King's territory was greatly interrupted. These interruptions appear to have constantly increased; for we find that, on March 26, 1793, a letter was addressed to the King of Kandy, by order of Governor Vande Graaf, "to inquire if, although no embassy was sent, the King would allow cinnamon to be peeled in his territories." The King's letter in reply stated, "that the peeling of cinnamon in his territories was usually allowed when the Company's ambassadors asked for leave to do it; and that it was in this, and in no other manner, that it could be done."

The Governor declined sending an ambassador on this occasion, and avows that he entertained fears that leave would not have been granted, and was afraid to risk the chance of a refusal, which might have prejudiced the respectability of the Company. It appears, however, to have been customary to send annually a messenger to the King of Kandy to request permission to cut cinnamon in his territory. To render this petition apparently less supplicatory and degrading, they dignified the bearer with the title of Ambassador, and used, after the treaty of 1766, to make a voluntary offer to the King of Kandy of leave for his subjects to collect salt in the neighbourhood of Chilam and Putlam, as an equivalent for his permission to cut cinnamon. This proposal was generally received by his Kandian Majesty with strong marks of disdain and indignation: on one occasion his reply was, "My subjects shall continue to collect salt on the coast as usual; and you have my permission to cut cinnamon, as formerly." These embassies were expensive, and the ambassadors necessitated to submit to the most degrading and humiliating formalities. By the treaty of 1766, the ceremony of kneeling before his Majesty by the Dutch ambassadors was to be dispensed with. Subsequent events rendered it expedient for the Dutch to yield to the renewed request of the King of Kandy to comply with the ancient usages of his Court. Neither the expense attending the embassies, nor the indignities offered to the ambassadors, or even the violation of right, would have alone or conjointly operated successfully in preventing the customary annual message. The chief cause was, that the Kandian Court received all the embassies and presents as a homage due to their monarch, who conducted himself with such an overbearing, haughty demeanour, even while the ambassadors were performing the degrading and abject ceremonies, which inveterate custom had rendered indispensably requisite to approach his presence, that the Colonial Government became alarmed lest the native Cingalese should suppose that they were dependant upon the Kandian Court; in fine, that they would entertain the same opinion as the King did himself.

By the year 1793, Governor Vande Graaf's exertions in extending the propagation of the cinnamon plant had so far succeeded that he was enabled to furnish the annual investment from the territory of the Company, including the plantations. In a memoir

addressed to Gerard Van Angelbeek, his successor, bearing date July 15, 1794, he congratulates him that in future they would not be under the necessity of flattering the Court of Kandy any longer.

G. Van Angelbeek's government was short, but destructive to the labours of the two preceding Governors in the cultivation of cinnamon. During his government little care was taken to defend it from cattle, or to prevent the plants from being overgrown with creepers and underwood.

Ceylon was reduced by a British force in February, 1796. The cinnamon found in the storehouses was sold by the captors to the English East India Company for 180,000*l.* I have not been able to ascertain the number of bales captured by the army. In the latter end of 1797 the quantity of 13,893 bales was brought to England.

Mr. North assumed the government of Ceylon in October, 1798, but was under the controul of the Governor-General in India until the year 1802.

The English Company, like the Dutch, engrossed the exclusive privilege of trading in Ceylon cinnamon: the natives of Ceylon, and all other persons, were debarred from the smallest participation in the commerce of this article. In December, 1798, a regulation was issued by the President in Council, Fort St. George, directing that every ship, &c. on board which a quantity of cinnamon above 20 lb. might be found, without authority from Government, should be confiscated, with all her cargo; and that for every pound of cinnamon, the quantity being less than 20 lb., a penalty of 50 star pagodas shall be paid. This prohibition continues in force.

The same year a number of chalias were sent to the Malabar coast by the Ceylon Government to bark and prepare casia. On proceeding to the forests, they discovered the cinnamon-tree growing in great abundance, which they divided into the fanciful sorts, or varieties, that they had been accustomed to do with the cinnamon produced in their own island. Specimens of the prepared bark were forwarded to Ceylon for the inspection of Governor North. Mr. Brown, the agent of the East India Company on the Malabar coast, considered this a most important discovery. I have not learned that any notice was taken of Mr. Brown's report.

In 1799 the Company exported from Ceylon 5642 bales.

During the same year Mr. Jonville, a French gentleman, who held an appointment in the Cinnamon Department, addressed a memorial to Governor North, wherein he sets forth that he had discovered that a cinnamon plant, when well taken care of, ought to produce 23 oz. of cinnamon every second year; whereas those at present in the Marandhan produce, in the same space of time, no more than four-tenths of an ounce per tree. These comparative calculations appear to have been made in a very unequal manner. The first is most probably the amount of the produce of a choice plant, or bush: the second is admitted to be the average produce of each plant in the plantation. No allowance is made for bad

soil, although there are many spots in the Marandhan so steril, or otherwise ill adapted for the cultivation of cinnamon, that the plants barely live, become stunted, and never afford cinnamon of a quality fit for the Company's investment.

Governor North, whose desire to promote and to engross the monopoly of the cinnamon trade appears to have been ardent, was evidently much influenced by the misrepresentations and sophistical arguments of M. Jonville. In 1799 he addressed an elaborate memoir respecting the cultivation and trade of Ceylon cinnamon to the Governor-General in Council. In this memoir we find that he had three grand objects in view: first, to obtain a sufficient quantity of cinnamon annually; secondly, at a cheap rate; and, thirdly, to preserve entire the Company's monopoly of this article. The annual consumption of cinnamon throughout the world he estimated at 5200 bales. In suggesting the means of obtaining this quantity he enters into an elaborate calculation, founded on the statements of M. Jonville, to ascertain how much cinnamon the Marandhan plantation could be made annually to produce. The conclusion he draws is, that this plantation alone would yield annually 13,618 bales. In prosecuting this subject, he strongly and precipitately recommends the immediate grubbing up of the cinnamon plants in the Kaderane plantation, and in the innumerable small plantations which were found in the private property of individuals, and eventually the plantations of Ekele and Morotto. The enormous, exaggerated estimation of the eventual produce of the Marandhan plantation, consequential to an improved mode of cultivation, led to unfortunate results, and afford a strong instance of the propriety of much caution being used before a mere speculative theory should be adopted.

Among the causes which induced Governor North to recommend the uprooting of the cinnamon growing in the plantation of Ekele and Morotto, he mentions their proximity to the sea. His imaginary fears respecting smuggling contributed greatly to his entertaining an opinion that the cinnamon produced in these plantations might be cut, and exported in a contraband manner. In this memoir the annual expense incurred on account of the Cinnamon Department is estimated at pagodas 30,409 29 52.

It does not appear that Governor North's suggestions were much attended to, or that his recommendations were adopted by the Governor in Council. The cinnamon was permitted to remain in the plantations which were recommended to be grubbed up, and the Marandhan continued to be cultivated, but with no extraordinary care. The discordant opinions of Governor North and M. Jonville probably contributed to prevent the immediate adoption of any important measure.

In September, 1800, we find M. Jonville, in a memorial addressed to the Governor, strongly recommending the rooting up of all the cinnamon plants, not only in the plantations of Ekele and

Morotto, but even in that of the Marandhan, and suggesting the propriety of cultivating the Kaderane plantation alone, which he deemed adequate to furnish the usual annual investment.

By the treaty of Amiens, concluded in March, 1802, the Batavian Republic ceded to his Britannic Majesty all their possessions in the Island of Ceylon which belonged before the war to the United Provinces. His Majesty's Ministers, deeming it prudent to permit the Company to continue to enjoy the monopoly of the Ceylon cinnamon trade, entered into an agreement with the Directors, which agreement stipulated that the Ceylon Government should furnish to the agent of the Company, who was to reside at Colombo, 400,000 lb. of cinnamon, or about 4,324 bales of $92\frac{1}{2}$ lb. each; for which they engaged to pay at the rate of 3s. sterling per lb. What cinnamon happened to be collected beyond this quantity was to be burned; and the Company agreed that whenever the cinnamon furnished was disposed of at a higher rate than to afford five per cent. profit, after defraying all expenses, the surplus was to be placed to the credit of the Ceylon Government. The Company was to be allowed five per cent. upon the value of all cinnamon sold by the Ceylon Government for the supply of the markets in India, but none was to be disposed of in India at a rate lower than 5s. per lb. This agreement was concluded for the year 1802; and I am not aware that any very material alteration in the terms of the contract has since been adopted.

The dispatch which announced to the Ceylon Government the conclusion of this agreement recommended that the cinnamon plantations should be limited, so as not to produce, one year with another, a quantity larger than that contracted for by the Committee; and should the island be able to afford a surplus quantity, the Minister recommended that a part of the cinnamon plantations should be converted into cocoa-nut gardens, and, where the soil would permit, into rice grounds. This recommendation appears to have been made in consequence of an erroneous opinion respecting the ease with which cinnamon could be collected, and the facility with which it might be cultivated. It is impossible to say how far Governor North's memoir contributed to the Minister's mistake.

The contracting parties, eager to retain the monopoly, and apparently ignorant that cinnamon was produced in many other parts of the world, as well as Ceylon, adopted the most effectual means to frustrate their own views, by limiting the cultivation of cinnamon, and by restricting its exportation considerably within the annual consumption of the inhabitants of the whole world. By these restrictive measures, a premium was offered to the rice merchants of other countries to endeavour to procure cinnamon at a cheap rate, and consequently to undersell the Ceylon cinnamon. The Ceylon Government appears to have entertained serious alarms that the market would be overstocked with cinnamon the produce of Ceylon; and, anxious to prevent a reduction of the price of the article,

adopted a most extraordinary measure, which was to employ workmen to root up the cinnamon in many of the plantations.

On Feb. 19, 1802, the Chief Secretary to Government addressed a letter (from which the following is an extract) to the President of the Board of Revenue and Commerce.

“ It being the intention of his Excellency the Governor that all the cinnamon gardens belonging to Government, except those of the Marandhan, Kaderane, Morotto, and Ekele, should be disposed of, his Excellency requests that you would give directions to the Agents of Revenue and Commerce in whose districts there are any cinnamon gardens, to advertise that they will be sold by public outcry on the first of May next: the purchasers to bind themselves to root out all the cinnamon trees, and destroy them; and all such trees belonging to private persons must likewise be destroyed.”

This measure conduced the rooting up the cinnamon in many of the plantations. In all those which were doomed to destruction the plants were entirely neglected, and allowed to be overgrown with creepers and brushwood, or browsed upon by cattle. No unusual activity was exerted to promote the cultivation of the four undestroyed plantations. Fortunately, however, the business of uprooting the plants was a work of great labour; and the purchasers of a number of the plantations failed to perform their agreement to its completion. Notwithstanding the unforeseen aid of these plantations, the usual investments became greatly reduced, and were obtained with infinite labour.

In July, 1805, General Maitland assumed the government of Ceylon. One of the first acts of this government was to arrest the progress of the dispossession of the cinnamon plantations. He readily saw the propriety of encouraging and increasing the cultivation of cinnamon, and adopted means which have been followed with great success. During his government the annual investments continued gradually to increase, and many hundred acres of new ground were planted. Less dependance was now placed on the supply from the Kandian territory, which was always uncertain, and subject to many impediments. His successor has, with unabated zeal, prosecuted the same policy: he has been particularly attentive to improve the situation of the cast of people employed in its cultivation and preparation.

The following is an account of the quantities of cinnamon belonging to the East India Company sold at their sales in the years 1803 to 1810 inclusive, with the sale amount thereof; likewise the quantities retained for home consumption:—

Year.	Quantity sold.	Amount.	Retained for Home Consumption.
1803 287,267 lb. ..	63,504 <i>l.</i> ...	8,762 lb.
1804 357,683	78,659	9,830
1805 200,962	52,565	6,672
1806 261,196	61,216	10,389

Year.	Quantity sold.	Amount.	Retained for Home Consumption.
1807 366,746 lb. ...	116,501 <i>l.</i> ...	7,947 lb.
1808 334,631	114,974	13,116
1809 433,624	153,626	10,267
1810 303,954	125,558	11,564

being, on an average of eight years, 318,258 lb.; and the sale amount 95,825*l.* per annum, or about 6*s.* per lb. The small quantity retained for home consumption is not included in this calculation.

This statement, when compared with the account of the cinnamon imported and sold at the Dutch East India Company's sales in the years 1785 to 1791 inclusive, proves that the annual quantity of cinnamon imported from Ceylon was considerably reduced, and that the price was diminished to nearly one-half the sum for which it was sold by the Dutch. The large importations of cinnamon which have, under the denomination of casia, for some time past been exported from Canton into Great Britain, America, as well as the British settlements in India, are the chief apparent causes of the diminished demand for Ceylon cinnamon, as well as of its reduced price.

I have not been able to discover a good reason for supposing that this traffic is of long standing. The Dutch about the year 1787 began to apprehend a formidable rivalship in the monopoly of the cinnamon trade from the Chinese. As the exportation of cinnamon from Canton has increased, the demand from that produced on Ceylon has been on the decay, and the price reduced. The cinnamon exported from Canton, although in general of an inferior quality, can be purchased at a comparatively low rate, and may be sold, even with a large profit, far under the Ceylon cinnamon.

The following are the quantities of casia imported and sold at the Company's sales from 1804 to 1808 inclusive, with the sale amount and average price:—

Year.	Cwt.	Amount.	Average price per cwt.
1804 1,507	17,433 <i>l.</i>	11 <i>l.</i> 11 <i>s.</i> 4 <i>d.</i>
1805 4,282	43,002	10 0 10
1806 1,588	7,881	4 19 4
1807 911	3,781	4 3 0
1808 381	3,891	10 4 5

The greater part of these quantities of casia came from China.

Under the denomination of casia buds, the following quantities of the receptacle of the cinnamon berry were imported and sold at the East India Company's sales in the years 1804 to 1808 inclusive, together with the sale amount, and average price per cwt.;—

Year.	Cwt.		Average price per cwt.
1804	678	4783l.	7l. 1s. 1d.
1805	520	4200	8 1 6
1806	292	1737	5 18 11
1807	0	0	0 0 0
1808	54	628	11 9 0

China exported in the year 1805 into the British settlements in India the product of the cinnamon plants, under the denomination of casia and casia buds, to the value of 72,670 rupees :—

Calcutta imported to the value of rupees ...	19,134
Bombay	51,190
Madras	2,346

Some part of this casia was exported from Calcutta to London. Bombay supplies the market of Massuah, Judda, Aden, Bushin, &c. and a great part of the consumption of this article in the Arabian Gulph.

In 1810 and 1811 China exported from Canton in country ships to the British settlements casia to the amount of 3019 piquels, or 401,527 lb. : in regular ships, 6 peculs 998 lb. In the same season were exported from Canton in American ships 1604 peculs, or 199,977 lb.

This quantity of casia is imported into Canton from the Sooloo, Archipelago, and other islands in these seas, and the different ports of Cochin China. We have no good authority for believing that any of it is produced in China.

The following is a statement of the quantity of cinnamon prepared in Ceylon, the quantity rejected on inspection, and the number of pounds exported annually on account of the East India Company, from the year 1804 to 1814 inclusive, with the annual expense of the Cinnamon Department from 1807 to 1814 inclusive :—

Year.	Quantity prepared.	Quantity rejected.	Quantity exported.	Annual Expense.		
	lb.	lb.	lb.		£	s. d.
1804	318,251	70,536	247,715			
1805	258,144	21,159	236,985			
1806	399,171	13,816	385,355	Rix Dollars.		
1807	447,453	72,828	374,625	122,270	13,042	2 8
1808	465,541	52,251	413,219	132,021	14,082	4 10
1809	522,358	208,783	313,575	155,845	16,623	9 4
1810	422,928	12,690	410,237	130,728	13,944	6 5
1811	407,803	36,3 3	371,480	135,397	14,444	6 11
1812	454,562	31,189	423,373	145,443	15,513	18 5
1813	318,184	43,922	274,262	179,978	15,748	8 2
1814	404,417	17,952	386,465	157,771	13,387	9 3

This statement shows that the average annual exportation of cinnamon on account of the Company, from the year 1804 to 1806 inclusive, amounts to 290,018 lb.; and that from the year 1807 to 1814 inclusive it amounts to 370,913 lb., and the annual expense for this period to 14,223*l.* or about 9*d.* per lb.

For a number of years included in this period the premium upon bills drawn upon the Company on account of the investment can not be estimated at less than 30 per cent. This premium is evidently amply adequate to liquidate the expense incurred annually by Government on account of the cultivation and preparation of cinnamon.

In 1804 a considerable quantity of oil was distilled from the rejected cinnamon: the quantity I have not been able to ascertain.

The Ceylon Government has for a number of years annually disposed of part of the rejected cinnamon to private merchants, and generally at about 2*s.* per lb. The merchants purchase it with the avowed purpose of supplying the Indian markets: great part of it, however, eventually reaches England under the denomination of casia.

Cinnamon oil to the amount of about 3,000 oz. has within these few months been prepared; a part of which has been forwarded to England.

By the foregoing statement, it will appear that the Ceylon Government gain very considerably by the cultivation and preparation of cinnamon. Cinnamon being a staple commodity on Ceylon and the Malabar coast, and as these situations possess many peculiar and natural advantages for extending the commerce in this article of trade, it appears to be a great want of foresight or industry to look with an eye of indifference upon the rapidly increasing trade of China in cinnamon. The cultivation of cinnamon might be carried to any extent on Ceylon, and with every prospect of profit.

The cheapness of labour, in consequence of the degree of servitude under which the chalias are held, and the universal prepossession in favour of the Ceylon cinnamon, are peculiar and powerful advantages, which, if judiciously improved, may greatly contribute to repress the China cinnamon trade, and to make it a profitable enterprise for the possessors of Ceylon.

Captain Melborn mentions a circumstance which renders it almost unaccountable why the Malabar cinnamon is not a more powerful rival to the China trade in this article. He tells us that the Canton price current of casia in 1809 and 1810 was 20 Spanish dollars per pecul, or about 9*d.* per lb.; and that casia is exported from Mangalore at from eight to nine pagodas per candy, or about 2*d.* per lb.

In addition to the China cinnamon trade, we may now expect to have to combat with the Dutch in the commerce of this article. This people are intimately acquainted with the spice trade, and particularly with that of cinnamon. The enterprising and perse-

ving character of the Dutch is proverbially known; and the possessors of Java have powerful means in their hands; so that we have no mean antagonists to oppose. Batavia may become the depôt of the cinnamon produced in Sumatra, the extensive island of Borneo, the Philippine and Sooloo Islands; and should these islands not afford a sufficient quantity to supply all demands, cinnamon can be furnished to a very great extent from Tonquin and Cochin China. The English at one time cut considerable quantities of cinnamon in Sumatra, and had chalias, whom they enticed from Ceylon, to prepare the bark. The quality of the cinnamon prepared by these people is stated to be equal to the finest in Ceylon. The Dutch, even when they had possession of the coasts of Ceylon, purchased the cinnamon produced in Sumatra, which they exported to foreign countries as Ceylon cinnamon.

To rival the excellence of the cultivated cinnamon of Ceylon, the Dutch will, in all probability, adopt measures for cultivating it in the island of Java, or in some of its immediate dependencies. A productive cultivation must be a work of time; and a period of 20 years will elapse before their exertions in cultivating cinnamon can greatly interfere with our present monopoly of that of the finest quality, for which we are chiefly indebted to the unwearied and judicious exertions of the Dutch.

It is very evident that our interest strongly points out that we should exert the powerful means which circumstances have placed in our power to cultivate, collect, and export, a greatly increased quantity of cinnamon, with the view of supplying the markets of both Europe and America; so as to render the trade less immediately profitable to our rivals, and less encouraging for them to attempt eventually to monopolize the commerce of this very important article.

This plan is evidently more laudable, and promises to be as successful as measures of restraint. The conduct of the Dutch in their attempts to preserve the monopoly of the clove and nutmeg trade should be regarded as a beacon to prevent us from splitting upon the same rock. They were anxious to engross the trade in these articles; it is our interest, exclusive of the produce of our own settlements, to reduce the cinnamon annually exported. They discovered that cloves and nutmegs were not confined to the islands and establishment which owned their way. We know that, although Ceylon produces cinnamon of a quality unequalled, yet we also know that the plant abounds in the eastern islands, and that they afford large quantities of a secondary quality. We have also strong reasons to believe that these islands would afford cinnamon which would rival the finest on Ceylon, were an equal attention extended to its culture and preparation.

The Dutch used every means in their power to limit the produce and diminish the exportation of cloves and nutmegs. This was done to increase the value of the article. These restrictive measures led to smuggling, and nutmegs

in different countries, and to voyages to ascertain whether they grew in islands and situations which had not been sufficiently explored.

We, on the other hand, have not collected and exported all the cinnamon which we might have done; and in so far as we have, from inattention or indifference, omitted to supply the demands of Europe and America with Ceylon cinnamon, this neglect has contributed to encourage the importation of cinnamon from China, which is now very generally substituted for the finest Ceylon cinnamon.

The means adopted by the Dutch to obtain the exclusive trade in cloves and nutmegs are worthy of attention, because, from the similarity of our prospects, their failure may teach us to avoid the same ineffectual or hurtful measures, and perhaps open our eyes to a more liberal, and not improbably to a more efficient and advantageous policy. Shortly after they had established themselves in the Moluccas, they attempted to confine the growth of the clove trees to the islands of Amboina, Honimoa, Oma, and Noussalant; and the nutmeg tree to the island of Banda. To carry their intentions into effect, they employed extirpators to destroy the clove and nutmeg trees that grew in the neighbouring islands which owned their sway; and they paid an annual tribute to the Kings of Ternate, Tidor, and Bonton, to permit and assist the extirpators to destroy the trees which abounded in the Archipelago, of which they were masters. When the crop of cloves and nutmegs was abundant, they burned large quantities, sometimes in the islands where they were produced, and sometimes after they had been landed in Holland. The contraband trade between the spice islands and the large island of Celebes they never could prevent. The English had generally an establishment, either on the main land of Borneo, or some of its dependencies; by which means they were always readily supplied by the natives with whatever spices they required, as they paid a higher price for them than the Dutch.

Captain Forrest ascertained that the nutmeg tree grew in New Guinea, and transplanted a number of plants to the Philippine Islands. The French have succeeded in introducing the clove and nutmeg trees into the Isles of France and Bourbon. They have likewise introduced them into Guiana and Cayenne. In the year 1785 there were 10,416 clove trees on the Isle of France. The English also have cultivated the clove tree in the West India islands. Martinico in the year 1797 imported into London 380 lb. and the year following 200 lb.; St. Kitt's, 2981 lb. The extreme cupidity of the Dutch eventually ruined their own prospects. Had they been contented with moderate profits, the incitement to a contraband trade would have been much diminished, and foreign nations would have had fewer incentives to incur much expense and labour in cultivating spices in their own establishments. Our situation with regard to the cinnamon trade is in many respects similar to that of the Dutch in the commerce of cloves and nutmegs:

we have too long gazed with a frigid indifference upon the rapidly increasing cinnamon trade of the Chinese, and treated with contempt their commerce in this article. Should it not rather have excited us to adopt effectual means to supply the demands of the western world from our own establishments? Even admitting that the cinnamon exported from China is inferior to the produce of Ceylon, its quality however is such as to serve as a substitute, and may eventually rival the best we can produce. The third quality of the Ceylon cinnamon is by many considered equal, if not superior, to that brought from China, and could in all probability be supplied at as low, if not a lower, price. This quality of cinnamon might in Ceylon be collected to an almost unlimited quantity. A large importation of this sort into the London market, and sold at a moderate profit, would in all probability soon lessen the demand for that imported from China.

By the London Price Current of Jan. 10, 1815, we find the different qualities of cinnamon quoted at from 8s. 3d. per lb. to 13s. 3d. The finest quality is becoming lower in price. In the same Price Current casia is quoted at from 40*l.* to 45*l.* per cwt. or from about 7s. to 8s. per lb. Inferring that the third sort of Ceylon cinnamon is of as good a quality, and will fetch as high a price as the Chinese cinnamon, the purchasers of the rejected Ceylon cinnamon must have found a good market, and have at least lately made a profitable speculation. Cinnamon oil is quoted at from 25s. to 26s. per oz. To procure an ounce of cinnamon oil about 11 lb. of cinnamon are required. While the oil fetches this price only, the Ceylon Government cannot, considering the expenses incurred, realise much more than 1s. 6d. per lb. for the cinnamon used in distillation; and it will evidently appear that when 2s. per lb. can be obtained, there is in general very little encouragement to expend much cinnamon in making oil.

The most certain, and undoubtedly the most avowable means of acquiring or preserving a monopoly of an article of commerce is to furnish it in abundance, at a comparatively cheap rate. The exportation of the third quality of cinnamon would very considerably contribute to this desirable end. Great part of the small quantity which has been exported has found its way into Europe and America under the denomination of casia. The duty levied upon that which has in trade been stiled casia, should be the same as is levied upon cinnamon, or the duty upon the third quality of cinnamon should be reduced to that which is paid upon the importation of the casia of commerce. The exportation of cinnamon of this quality to England would at any time have been of importance to the trade of Ceylon; but in consequence of the recent entire subjugation of the interior of the islands, this measure becomes of infinitely greater consequence. By the fortunate termination of the Kandian war, the sources and opportunities for collecting and preparing cinnamon are increased. The enlarged quantity procurable will, however, be chiefly of the third sort; and without

some means be adopted for collecting and exporting this quality of cinnamon, it will appear like neglecting one of the many advantages which promise to follow this very important acquisition. With the exception of the narrow indented valleys which intersect the hills and mountains, great part of the interior of Ceylon is covered with lofty trees and low brushwood in the most luxuriant degree of vegetation. The most rugged and difficultly accessible mountains and situations abound more with large trees than those hills or eminences whose declivity is more gradual, and whose surface is more even. This arises chiefly from the chena or dry grain cultivation, which is much practised upon the most accessible of the hills in the interior. Chenas are cultivated by cutting down a number of the large trees and all the brushwood upon the declivity or top of a hill. The trunks and branches of the large trees and the shrubby bushes are burned, and the ashes spread upon the ground, which is eventually sown with dry grain. The roots of the trees and bushes are allowed to remain. One crop only is reaped. The spot of partially cleared ground becomes in a few years covered with underwood and young trees. The space of from 15 to 20 years elapses generally before the ground is again cleared and another crop sown. This statement will readily account for a circumstance confirmed by the chalias, that on the rugged and difficultly accessible hills large cinnamon trees, which afford cinnamon of a coarse quality, are found, and that cinnamon plants of an age well adapted for yielding fine cinnamon are obtained upon the recently cultivated chenias. These patches of high ground cultivation form, however, but a small proportion, when compared to the uncultivated and uncultivable, rugged, and precipitous mountains, with which the interior of the island abounds. It may likewise be mentioned that the cinnamon plant is less hardy than many of those which grow in the same jungle with it; and that when its shoots are cut, and the young scions only permitted to remain, the plant becomes less, and less able to resist the encroachments of the surrounding underwood, by which means it not unfrequently becomes choked and overgrown.

Another, and not an unimportant concern, demands the attention of Government—the collection and preparation of the receptacle of the embryo seed of the cinnamon plant, the casia bud of commerce. The full grown trees of the interior will afford them in great abundance. They are frequently substituted for the more expensive cinnamon, and fetch a good price. The collection of them in Ceylon might be extensive, and effected at a very small expense. Labour, which is all that is required, is cheap. They could be collected by boys: and the drying, sorting, &c. of them might be entrusted to females. We might soon be able to rival the Chinese monopoly of this article. The Dutch, however eager they were to extend the exportation of colonial produce, seem to have entirely neglected the preparation of this important article of trade. Indeed I have not been able to learn that they were aware of the

fact that casia buds are the produce of the cinnamon plant. The native headmen now employed in the Cinnamon Department, and who were in the same situation under the Dutch, express their entire ignorance of the circumstance.

In the London New Price Current of Jan. 10, 1815, casia buds are quoted at from 32*l.* to 37*l.* per cwt., or from about 5*s.* 6*d.* to 6*s.* 6*d.* per lb. The profit upon this article might be considerable. The more carefully and extensively we consider the subject, we shall, I think, be the more convinced that we must trust chiefly to the plantations for cinnamon of the finest quality, and that, notwithstanding the recent important acquisition of the interior of the island, we should prosecute the cultivation of cinnamon with unabated zeal and perseverance.

ARTICLE V.

Description of the Timekeeper and Pendulum for which the Society of Arts voted their Gold Isis Medal and 20 Guineas to Mr. W. Wynn, Farnham, during their last Session.

THE scapement acts as the common dead scapement; but the pallets are constructed of segments of cylinders, which move on small axes during the whole time the tooth of the wheel is in contact with each; which reduces the friction in that important part at least nineteen-twentieths as compared with the dead scapement. Small cylinders are placed instead of the leaves in the pinions, which go round on pivots one-fifth of their diameter when the teeth of the wheels are in contact with them: consequently four-fifths of the friction is there got rid of. The pivots of all the movement wheels are suspended on friction wheels, which diminish their friction 20 or 25 to one in those parts, and supersede the use of jewels. The motion wheels and pulley are entirely dispensed with. Besides the advantage of getting rid of so much of that changeable resistance—the effect of friction, an important one is gained; for it will not be necessary to oil any part of this movement, which is usual in others. No part but the pivots of the friction wheels and cylinders will require oil; and those are so remote in point of influence, that the maintaining power and the resistance of the friction of the scapement will be always equal in all variations of temperature and foulness. The pendulum must, therefore, oscillate at all times in an equal arc of vibration, which will prevent the necessity of using any artificial means to preserve the isochronism of unequal arcs. The pendulum is constructed with compensating rods, but has all its rods at rest, except the one which supports the ball: it therefore does not suffer that resistance in passing through the air as the gridiron one, which resistance is

always subject to change, from the continual variation of the density of the atmosphere. It is also made in such a manner that the proportionate lengths of the compensating rods can be altered in the most minute degree: consequently they can be adjusted with the greatest accuracy: a thing which has hitherto been difficult, or perhaps impossible, to accomplish.

ARTICLE VI.

Improvement in the Oxygen and Hydrogen Blow-pipe. By Mr. Osbrey.

(To Dr. Thomson.)

SIR,

NOTWITHSTANDING the various ingenious contrivances proposed by your numerous correspondents to render the use of Brooke's blow-pipe free from danger, it does not appear to me that so desirable an object has been heretofore accomplished, or that the safety of the operator is completely secured by any of them: for the number of the *Annals of Philosophy* for August, p. 133, Dr. Clarke acknowledges the necessity of using precaution before igniting the gas, which implies some hazard if not attended to. It struck me, also, that as there is so considerable a degree of heat extricated by the sudden compression of atmospheric air as to cause combustion, as it does in the small tubes and pistons used for lighting matches, if the same effect was to take place in condensing the explosive gases the consequence might be serious: at the same time I am not certain that such an effect is likely to be produced. It having occurred to me that the simplest and most certain way to avoid the danger incident to the use of a mixture of gases in a highly condensed state, so extremely explosive as those which constitute the basis of water, would be to construct a reservoir of such strength as to be able, should an explosion take place, to resist their expansive force; and, before perfect reliance should be placed on it, to subject it to such proof as would remove all apprehension in its subsequent use. Having got one executed according to this idea, and finding it answers satisfactorily the end proposed, I now offer for your consideration and insertion in your periodical publication, if you think the communication worthy of your notice, a description of it, accompanied by a drawing (Plate LXXIII. Fig. 2), together with the result of two experiments in proving it.

I procured a copper cylinder about three-eighths of an inch thick. A bottom of the same thickness was screwed into it, and soldered with soft solder. A top was fitted to it by grinding, and secured by 10 iron screws. This internal reservoir, into which the gases, after being mixed, are condensed, is supported by a wrought

iron case, made by coiling a bar of the best Swedish iron $1\frac{1}{2}$ inch square round an iron mandril, and welding it in the manner twist gun-barrels are manufactured. This, after being turned in a lathe, had ends made of scrapped iron fitted to it, and made fast, each by 2 screws half an inch thick. This case was sufficiently large to admit the copper reservoir freely into it, the space between being filled with melted lead. A stop-cock was screwed into the copper cover with a projection, or *flanch*, round it, which was pressed by the iron outside cover for greater security. In order to prove it, electricity afforded me the ready means of igniting a known quantity of the gases in as highly a condensed state as it was possible to obtain them with the syringe employed. For this purpose I had a wire insulated, by cementing it in a glass tube, and cementing this again into another of brass, and screwed into the opening in the cover destined for the jet of air to blow through, and passed down to a proper distance from the bottom of the reservoir, so that a spark might pass. Between the iron and the copper cover a piece of leather was fitted, in order that the iron might the better sustain the copper. I had it then placed in such a position at a distance on the outside of my laboratory, that it could be observed without risk, though it should burst. The wires connecting it with the jar of an electrifying machine passed through the window. Things being in this state, the reservoir was exhausted, and a quantity of mixed gas equal to 800 cubic inches condensed into it. The internal capacity had been found equal to 60 cubic inches; so that it then contained about 13 atmospheres. On passing the electric spark, a slight explosion took place, equal to that of a pocket pistol, accompanied by a dense vapour which had a peculiar smell. On opening and examining the reservoir, the glass tube was found broken, the cement thrown off with an appearance of having been melted, and the wire which conveyed the electric fluid broken in two places. The whole interior was covered with an ash-coloured, oily, moist substance; but the quantity of water was very inconsiderable, the vapour having escaped through the joining of the copper cover. The heat was so intense that it carried some of the metallic lead, and deposited it on the leather which had been placed between the copper and iron. The bottom was also forced, so that it became necessary to take it asunder: this was easily effected by heating the whole, and melting out the lead.

Not being satisfied with this first experiment, I was determined to endeavour to make the reservoir remain unchanged by the explosion. For this purpose I had a ring of copper soldered into the mouth of the copper vessel with hard solder, and the outside tinned, the space between the copper and iron filled by melted tin. The whole, having been suffered to cool, formed a solid mass of nearly two inches in thickness. A plate of lead was fitted to the space on the copper cover instead of leather, in the manner that the iron cover pressed it equally. It being filled with the same quantity of gas as before, and fired in

noise was observed, and all remained perfectly close as before the explosion. On examination, there was found within the reservoir very little more air than filled it at the ordinary pressure; for on applying an empty bladder to the stop-cock, there passed into it a cubic inch or better of air. I did not examine the quality of this residuary air. It might have arisen from the impurity of the gases employed. The oxygen gas I obtained from black oxide of manganese; the hydrogen, from zinc and diluted sulphuric acid.

Having thus satisfied myself as to the strength of this reservoir, I had it polished on the outside; a circular brass plate fitted to the top, with a groove turned in it, to receive the heads of the iron screws; a mahogany stand, made fast to the bottom by screws, forms the base. The whole was then varnished with coach-makers' copal varnish, which I find excellent for preserving polished iron from rusting.

The only contrivance I think necessary to use with this reservoir is the fagot of tubes made use of by Dr. Clarke, and this merely to prevent the waste of gases by the useless generation of water. I am indebted to Mr. Samuel Yeates, an ingenious instrument-maker of Dublin, for the idea of a glass fagot of tubes, which he procured me, and which answers all the purposes of one of brass, at a very small expense.

I must own now that I have ascertained the practicability of making a reservoir that will bear proving. I should prefer having it bored out of solid copper, screwing it in a cover, and securing it with screws; but by no means would I omit having it proved. My reason for preferring copper is, besides its great tenacity, the little chance of its being acted on by any chemical agents likely to be present.

The section shows the manner of putting the whole together, and the insulated wire for passing the electric spark, &c.

I am, Sir, your very humble servant,

Rathgar, near Dublin, Sept. 1, 1817.

THOMAS OSBREY.

EXPLANATION OF THE PLATE.

- A, A, Fig. 3, the internal copper reservoir.
- B, B, the iron case.
- C, C, C, C, screws fastening the ends of the iron case.
- D, D, D, the space filled with tin.
- E, the stop-cock through which the gases are condensed.
- F, the wire cemented into a glass tube.
- G, a ball on the end of the wire to pass the electric spark.
- H, the brass cap.
- I I, the copper ring soldered inside the copper cylinder.
- K, the mahogany base.

ARTICLE VII.

A General Table of the Proportions of dry Muriatic Acid corresponding to progressive Specific Gravities of the Liquid Acid; with Observations on the Law of Progression. By Andrew Ure, M.D. Professor of the Glasgow Institution, Member of the Geological Society of London; and of the Faculty of Physicians and Surgeons, Glasgow.

THE experiments detailed in my paper on hydrochloric acid, &c. published in the last number of the *Annals of Philosophy*, afford, I presume, satisfactory evidence that liquid acid having a specific gravity of 1.1920 contains 28.3 parts in the hundred of dry muriatic acid on the old hypothesis; equivalent to 36.5 chlorine and 37.6 hydrochloric acid gas by the new. Several months having elapsed since the above paper was written, some general views concerning the relation between the specific gravity and degree of dilution of acids have since occurred to me; the application of which to the present subject, as well as the extension of the table, may probably prove not uninteresting to the chemical world.

The experimental results on the temperatures produced on mixing water and muriatic acid; those on the capacities for heat of the acid in its more and less concentrated state; and the specific gravities corresponding to successive decades of dilution,* were executed with the utmost nicety, and are, therefore, I believe, entitled to confidence.

In the course of my researches on sulphuric acid, published in the last number of the *Journal of Science and Art*, I was necessarily led to inquire more minutely into the *cause* of the heat evolved in the dilution of muriatic acid; and I then found that if the mean density of the components be computed by the rigid formula for this purpose, we shall perceive it to be uniformly *less* than the experimental specific gravity. Hence this acid forms no longer an exception, as Mr. Kirwan taught, to the general law of condensation of volume, which other liquid acids obey in their progressive dilutions. Hitherto, indeed, many chemists have, without due consideration, assumed the half sum, or arithmetical mean, of two specific gravities, to be the true calculated mean; and on comparing the number thus obtained with that derived from experiment, they have inferred the change of volume, occasioned by chemical combination. The errors into which this false mode of computation leads are excessively great when the two bodies differ considerably in their specific gravities. A view of these erroneous results is given in the third table of on sulphuric

* The specific gravity opposite to $70 + 30$, in the 1.1844; it should be 1.1344.

acid, above referred to. When, however, the two specific gravities do not differ much, the errors become less remarkable. It is a singular fact that the arithmetical mean, which is always greater than the rightly computed mean specific gravity, gives in the case of liquid muriatic acid an error in excess very nearly equal to the actual increase of density. The curious coincidence thus produced between accurate experiments and a false mode of calculation is very instructive, and ought to lead chemists to verify every anomalous phenomenon by independent modes of research. Had Mr. Kirwan, for example, put into a nicely graduated tube 50 measures of strong muriatic acid, and poured gently over it 50 measures of water, he would have found, after agitation, and cooling the mixture to its former temperature, that there was a decided diminution of volume, as I have experimentally ascertained.

For computing the mean specific gravity of a mixture of two or more bodies, the simplest, and at the same time an absolutely exact rule, is to divide the sum of their weights by the sum of their volumes. The density of all bodies being referred to that of water called unity, by volumes we consequently mean the weights of their respective volumes of water; which weights are found by any of the well-known areometric or hydrostatic methods. And if we divide the weight of a body by its specific gravity, we shall have the bulk of the body compared to the bulk of the same weight of water. Thus 1000 grains of muriatic acid sp. gr. 1.1920 will occupy in a measure tube the space occupied by 839 grains of distilled water. Now if we calculate the densities of successive dilutions of that liquid muriatic acid by the preceding rule, we shall have the following table of quotients, to which I have added the experimental specific gravities, and the resulting volumes:—

Dilute Acid.	Calculated sp. gr.	Sp. Gr. by experiment.	Resulting volume.
90 A + 10 W $\frac{(90 \times 0.839) + 10}{}$	= .. 1.16945 1.17360 99.65
80 A + 20 W $\frac{(80 \times 0.839) + 20}{}$	= .. 1.14784 1.15500 99.38
70 A + 30 W $\frac{(70 \times 0.839) + 30}{}$	= .. 1.12701 1.13525 99.27
60 A + 40 W $\frac{(60 \times 0.839) + 40}{}$	= .. 1.10693 1.11475 99.29
50 A + 50 W $\frac{(50 \times 0.839) + 50}{}$	= .. 1.08754 1.09540 99.28
40 A + 60 W $\frac{(40 \times 0.839) + 60}{}$	= .. 1.06883 1.07655 99.28
30 A + 70 W $\frac{(30 \times 0.839) + 70}{}$	= .. 1.05075 1.05700 99.40
20 A + 80 W $\frac{(20 \times 0.839) + 80}{}$	= .. 1.03327 1.03800 99.54
10 A + 90 W $\frac{(10 \times 0.839) + 90}{}$	= .. 1.01636 1.01900 99.74

Since we now find that the mean and experimental densities can longer be assumed to be the same as they have hitherto been, it comes necessary to construct a particular table of specific gravities every per centage of dilution. This may be done either by individual experiments for each successive term, or by knowing the law which connects the density and proportion of acid. Having covered this law, and verified its accuracy by experiments, we may safely dispense with the former laborious and irksome method. The same series which I have developed for sulphuric acid will, with a slight modification, apply to muriatic. The number representing the specific gravity, at 10 per cent. of liquid acid, being taken as the root (water being called 1000), then the specific gravities corresponding to 20, 30, 40, 50, &c. per cent. are the successive powers of that root, *minus* 0.2, 0.3, 0.4, 0.5, &c. Thus, for example, at 10 per cent. we have 1019, the primitive root; and $(1019 - 0.2)^2 = 1038$ is the specific gravity at 20 per cent.; $(1019 - 0.3)^3 = 1057$ is that at 30; and so forth.

In consequence of the more rapid flexure of the curve of condensation near the beginning of the above table, the roots for 90 and 100 are 1018 and 1017.7 respectively; which, therefore, at these points, have been employed in constructing the following table.

Acid having a specific gravity of 1.1920 is as strong as it is comparable to make or employ in chemical researches. To find the strength of acid in that possessed of greater density, we have only to dilute with a known proportion of water till it come within the range of the table.

Table of the Quantity of dry Muriatic Acid corresponding to successive Specific Gravities of the liquid Acid.

Sp. Gr.	Acid in 100	Sp. Gr.	Acid in 100	Sp. Gr.	Acid in 100
1.1920	28.30	1.1531	22.36	1.1115	16.41
1.1900	28.02	1.1510	22.07	1.1097	16.13
1.1881	27.73	1.1491	21.79	1.1077	15.85
1.1863	27.45	1.1471	21.51	1.1058	15.56
1.1845	27.17	1.1452	21.22	1.1037	15.28
1.1827	26.88	1.1431	20.94	1.1018	15.00
1.1808	26.60	1.1410	20.66	1.0999	14.72
1.1790	26.32	1.1391	20.37	1.0980	14.43
1.1772	26.04	1.1371	20.09	1.0960	14.15
1.1753	25.75	1.1351	19.81	1.0941	13.87
1.1735	25.47	1.1332	19.53	1.0922	13.58
1.1715	25.19	1.1312	19.24	1.0902	13.30
1.1698	24.90	1.1293	18.96	1.0883	13.02
1.1679	24.62	1.1272	18.68	1.0863	12.73
1.1661	24.34	1.1253	18.39	1.0844	12.45
1.1642	24.05	1.1233	18.11	1.0823	12.17
1.1624	23.77	1.1214	17.83	1.0805	11.88
1.1605	23.49	1.1194	17.55	1.0785	11.60
1.1587	23.20	1.1173	17.26	1.0765	11.32
1.1568	22.92	1.1155	16.98	1.0746	11.04
1.1550	22.64	1.1134	16.70	1.0727	10.75

Table continued.

Sp. Gr.	Acid in 100	Sp. Gr.	Acid in 100	Sp. Gr.	Acid in 100
1·0707	10·47	1·0457	6·79	1·0209	3·11
1·0688	10·19	1·0438	6·51	1·0190	2·83
1·0669	9·90	1·0418	6·23	1·0171	2·55
1·0649	9·62	1·0399	5·94	1·0152	2·26
1·0629	9·34	1·0380	5·66	1·0133	1·98
1·0610	9·05	1·0361	5·38	1·0114	1·70
1·0590	8·77	1·0342	5·09	1·0095	1·41
1·0571	8·49	1·0324	4·81	1·0076	1·13
1·0552	8·21	1·0304	4·53	1·0056	0·85
1·0533	7·92	1·0285	4·24	1·0037	0·56
1·0514	7·64	1·0266	3·96	1·0019	0·28
1·0495	7·36	1·0247	3·68	1·0000	0·00
1·0477	7·07	1·0228	3·39		

If we wish to convert the above dry acid into the hydrochloric acid gas of Sir H. Davy, we multiply the number by 1·329; and to convert it into chlorine, multiply by 1·29.

In the investigation of the above logarithmic series, a very simple rule occurred to me for computing directly, and without a table, the quantity of real acid existing in the liquid at any proposed density. Multiply the decimal part of the specific gravity by 148, the product will be very nearly the per centage of dry muriatic acid; or by 197, when we shall obtain that of hydrochloric gas.

Examples.

I. Let the specific gravity be 1·1410; required the proportion of dry muriatic acid in 100. $0·141 \times 148 = 20·86$; by the table we have 20·66, opposite 1·1410.

II. The specific gravity is 1·0960. $0·096 \times 148 = 14·2$. The table gives 14·15 at 1·0960.

III. The specific gravity is 1·0380. $0·038 \times 148 = 5·62$. Experiment gives 5·66.

The differences are inconsiderable.

ERRATA IN LAST NUMBER.

Page 271, line 44, for litmus, read turmeric.

Page 272, line 3, second column of table, for 1·1844, read 1·1344.

Page 272, line 7, same column, for 1·0574, read 1·0576.

Page 277, line 18, for 308·5, read 306·5.

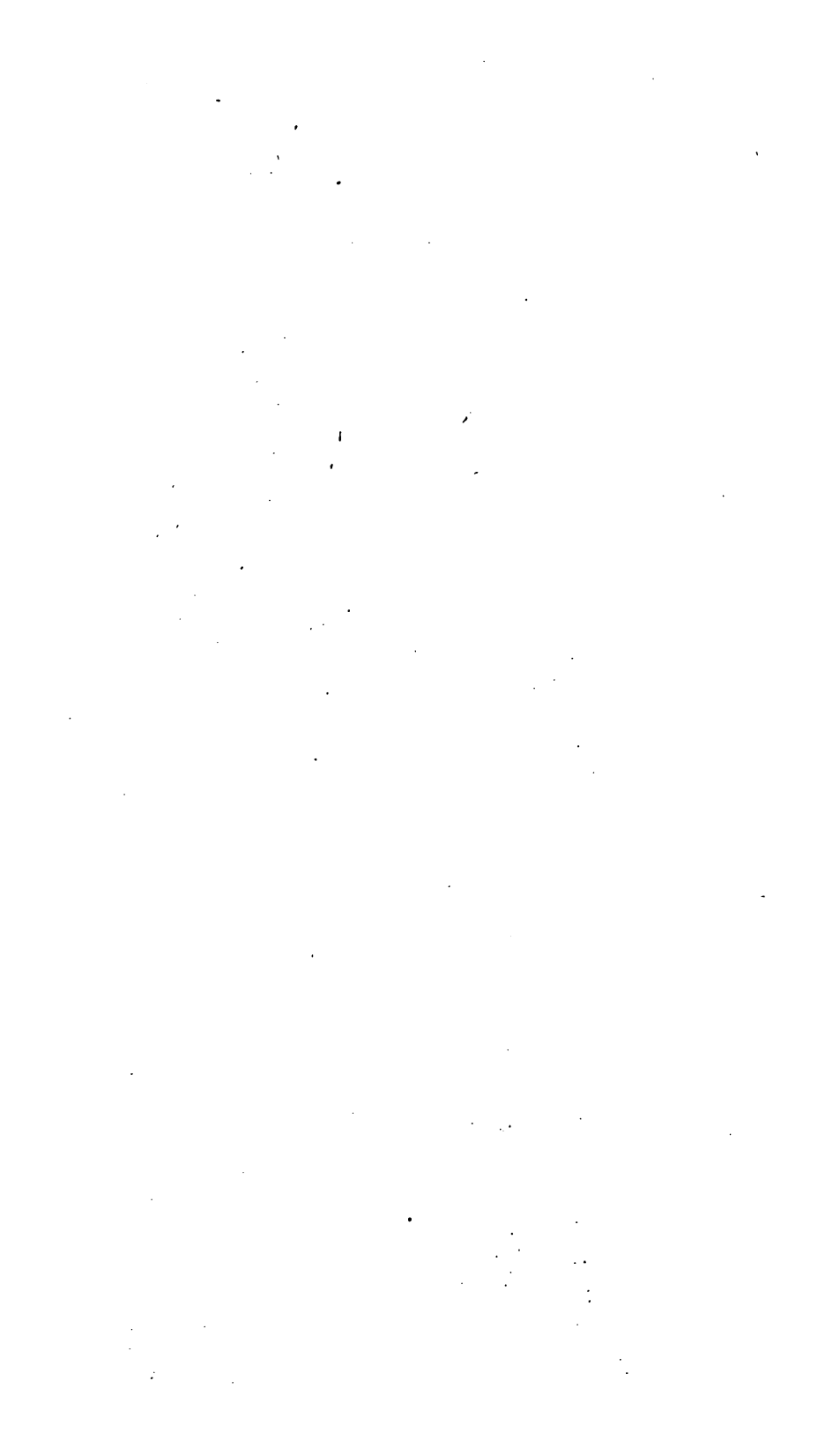

Fig 1.

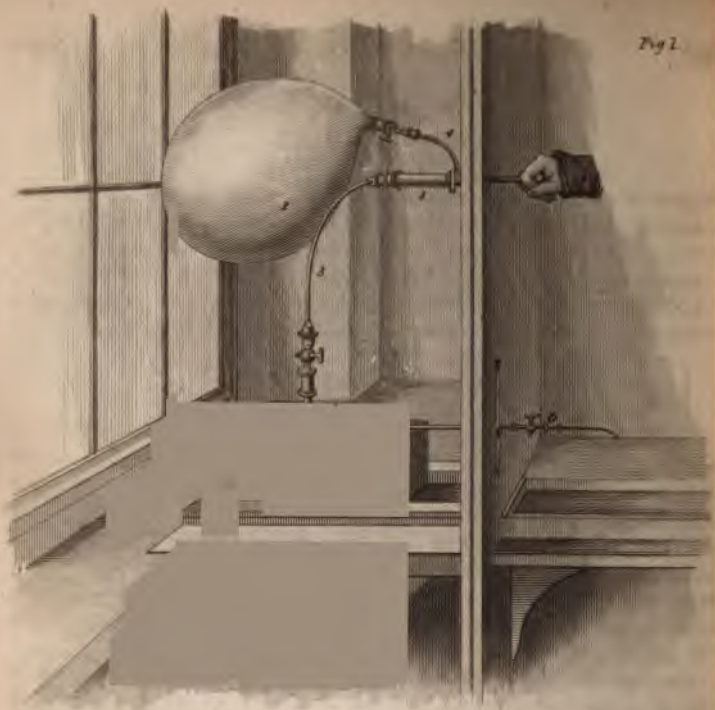
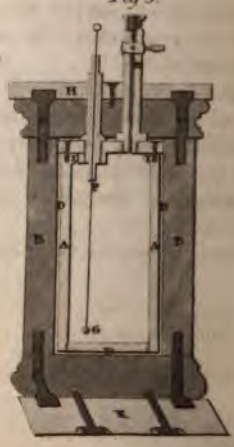

Fig 2.



Fig 3.



ARTICLE VIII.

Account of an Improvement made in the Gas Blow-pipe; with some additional Remarks upon the Revival of Metals from their Oxides, and of the Fusion of refractory Bodies, by Means of the same Instrument. In a Letter to the Editor by Edward Daniel Clarke, LL.D. Professor of Mineralogy in the University of Cambridge, Member of the Royal Academy of Sciences at Berlin, &c.

(To Dr. Thomson.)

SIR,

I HAVE the satisfaction of making known to you and to your chemical readers an improvement which I have lately made in the *gas blow-pipe*; by which the safety of the operator, and its powers of fusion, have been considerably increased. It has already enabled me to extend the use of this *blow-pipe* in some measure to the arts; and has tended greatly to facilitate a number of experiments, which before were attended with difficulty, owing to the interruption caused by the necessity of replenishing the *gas* reservoir, as often as it became exhausted.

In explaining the nature of this improvement it will be proper to refer to a former number of your *Annals*,* in which there is an engraved representation of a screen which I had adopted as a precaution of safety in using the *gas blow-pipe* in the common way. The same *screen* is again represented in the drawing which accompanies this article (Plate LXXIII. Fig. 1); only the spectator, instead of being placed opposite to it, is supposed to view its edge only; that the whole apparatus, which is very simple, may be exhibited at the same time.

No. 1 represents a *bladder* containing the usual gaseous mixture of *hydrogen* and *oxygen*.†

No. 2, the *syringe*; the handle of the piston being placed on the outside of the screen, so that it may not be necessary to open the door of the screen after the bladder has been fixed, as at No. 1.

No. 3 is a *brass tube* conducting *gas* from the *syringe* into the *reservoir* at No. 5.

No. 4 is another *tube of brass*, by which means the *bladder*, instead of being fixed close to the *piston*, is held at such a convenient distance, as not to incommode the operator, or to interfere with the rest of the apparatus. The *piston* at No. 2 is worked horizontally, instead of vertically, as in the former mode of using this *blow-pipe*.

For the purpose of using this apparatus, the stop-cocks are all to

* See No. XLIX. plate facing p. 91.

† To obtain the greatest degree of heat, I have lately altered the proportion between the two *gases*; and find that a mixture, by bulk, of seven parts of *hydrogen*, with three parts of *oxygen gas*, answers better than that of two to one.

be opened, excepting the small one of the *jet* at No. 6; and after 40 or 50 strokes have been given with the *piston*, the operator gently opening the *jet* by means of No. 6, applying his ear at the same time to the *reservoir*, No. 5, is to listen, and thereby to ascertain, by the bubbling noise of the *oil* in the *safety cylinder*, whether that fluid be in its proper place. Finding this to be the case, he is to close the *jet*, and all is ready for use.

As soon as the *gas* has been ignited at the mouth of the *jet*, the *syringe* at No. 2 is to be kept working; continual strokes being made with the *piston* during the whole time that the *gas* is suffered to escape and to undergo combustion; by which means an uninterrupted stream of *ignited gas* may be maintained so long as any of the gaseous mixture remains in the *bladder* at No. 1. I had the good fortune to procure a bladder capable of containing $4\frac{1}{2}$ gallons of *gas*; owing to which circumstance I maintained an uninterrupted stream of *ignited gas* during $8' 30''$; the *gas* being consumed nearly at the rate of $4\frac{1}{4}$ pints, in a minute: whereas with the original apparatus the *reservoir* became so speedily exhausted, that the experiments were constantly liable to interruption, owing to the necessity of its being replenished. And if, instead of using a *bladder* to contain the *gas*, a silk balloon varnished with a solution of *caoutchouc** could be substituted, it might be made of such magnitude as to allow of a constant current of *ignited gas* for almost any given time requisite during the most protracted experiments.

The apparatus which I have described was constructed for me by Mr. Neuman, of Lisle-street, Leicester-square; who entertained some doubts as to the practicability of using it, grounded upon the idea that the *gas* would escape faster than it could be supplied by the *piston*; and that a retrograde movement of the flame from the *jet* might thereby ensue; but I have not found this to be the case: on the contrary, the success of it has surpassed my most sanguine expectations; for the action of the *piston*, by its distance from the *reservoir*, has never affected the presence of the *oil* in the *safety cylinder*; which sometimes happened with the former apparatus; whereby an explosion was more than once occasioned. Both the safety of the *blow-pipe*, and its power of fusion, have been, therefore, greatly increased by its present mode of construction; and the results which it has enabled me to obtain shall now be stated.

I began by placing a *cupel* beneath the *jet*, and using a bent tube above it, like that which is represented in the *plate*; so that the current of *ignited gas* might act perpendicularly upon any substance placed within the *cupel*. A small quantity of *platinum* was thus melted; and, while the metal remained in a state of perfect fusion and ebullition, more *platinum* was added; until half an ounce of the metal was rendered perfectly liquid; and this, being suffered to cool, was obtained in the form of a

* Mr. Sadler, sen. informed me that the balloon with which he ascended from Devonshire House, in Piccadilly, was thus coated, with a solution of *caoutchouc*.

bullet. It was then rolled out, and made into wheels, with a view of being used for chronometers by a mechanist of this town. I have sent to you a wheel of this description. Very curious alloys of different metals have also been obtained; and especially a small ingot of pure precipitated gold alloyed with rather less than ten per cent. of *platinum*; of which some beautiful works have been wrought; possessing a fine gold colour, without being liable to become tarnished. Messrs. *Runnell* and *Bridge* have lately polished some of this alloy: which had been coarsely wrought in this place. The extended use, therefore, of the *gas blow-pipe* to the arts, may be said to have commenced; it will remain for others, more interested in this application of it, to further its progress. I will now recur to its more philosophical application.

As soon as I had observed that all *metals* might be revived from their *oxides* by means of this *blow-pipe*, I endeavoured to obtain pure precipitates of those which are the least known in the *metallic* form; beginning with *uranium*. Following the rules suggested by *Klaproth*, in his analysis of *pechblende*,* I endeavoured to obtain a pure *oxide* of this metal. He considers the phenomenon of its acid solution yielding a *deep brown red* precipitate to the *prussiate of potash* as "one of the most characteristic properties by which this metallic substance is distinguished." I obtained this precipitate: and the same acid solution which afforded it, yielded also a *yellow* precipitate, when, instead of the *prussiate of potash*, a *caustic alkali* had been added. In fusing these precipitates, after they had been carefully washed and dried, and mixed with oil, a *metal* was revived, resembling *iron*; being also *magnetic*; and when re-dissolved in acids yielding a *blue* precipitate to *prussiate of potash*; hence it was evidently contaminated at least with *iron*. I then exposed to the *ignited gas* a crystal of the pure *yellow oxide* of *uranium* in a *charcoal* crucible; and in this manner obtained a *metal* resembling *iron* which was not *magnetic*; and which had all the characteristic properties ascribed to *uranium*. Afterwards I proceeded in a course of experiments with some of the other *semi-metals*, and with similar success.

At this time (Oct. 10) *Professor Kidd*, of *Oxford*, paid a visit to *Cambridge*, with a view of being present at my experiments; intending to introduce the use of the *gas blow-pipe* at his own lectures. Several Gentlemen of this University were present when I exhibited to the Professor some of the most remarkable results which I had before obtained; especially the *metal of barytes*; and the phenomenon deciding its *metallic* nature; of which he repeatedly expressed his conviction.* *Professor Hailstone*, being also present, had brought with him a small quantity of that *yellow* precipitate, which is by some considered as an *acid*, and by others as

* Analytical Essays, vol. i. p. 476, Lond. 1801.

† I have received a letter from *Professor Kidd* since his arrival in *Oxford* which he expresses again his conviction that this "*metal*, which he first considered as an *acid*," was the *metal of barytes*."

an oxide, of *tungsten*.* We made it, as usual, into a paste, with a little *olive oil*; and then placing it in a *charcoal crucible* beneath the *jet* of the *blow-pipe*, we suffered the *ignited gas* gradually to act upon it. Fusion ensued; accompanied by the partial volatilization of the metal; depositing first a fine deep *blue oxide*, and afterwards a *yellow oxide* upon the iron forceps used as a support for the crucible. Its further volatilization was now checked; and upon examining the crucible, all who were present had the satisfaction to witness the perfect revival of the metal; appearing as a superficies investing the surface of the *charcoal*. It was surrounded by globules of a highly limpid glass. We afterwards repeated the same experiment, and with the same success. Judging from the appearance exhibited by *tungsten*, when thus revived upon *charcoal*, which however may affect its colour superficially, this metal has a cupreous aspect, intermediary between that of *gold* and *copper*.

Our next experiments related to the fusion of the most refractory native compounds of the *metals* of the *earths*; but as I have before circumstantially described the changes which such bodies undergo when exposed to the *ignited gas*, I shall not now repeat my former observations. While *Professor Kidd* remained with me, two *emeralds* discovered by the *Rev. Mr. Mandell* in *Cumberland*, at the foot of *Carrach Fell*, were, by his desire, submitted to the action of the *gas blow-pipe*; when their fusion being instantaneous, they ran together in a liquid state. These *emeralds* were supported in a small *charcoal crucible*. As soon as their fusion had taken place, the mass began to boil; and it was so liquid that a slight detonation taking place at the mouth of the *jet*, a portion of the liquid matter was scattered out of the crucible, and fell in minute globules upon a sheet of white paper. The *Peruvian emerald* is known to be fusible with difficulty before the common *blow-pipe*; but the *beryl emerald* was often considered as one of the most *infusible* bodies; and in all my own experiments with the common *blow-pipe* I have found it to be utterly *infusible*.

Before I conclude this article, it will be satisfactory to your readers to add, that as the experiments for the exhibition of the *metallic* nature of *barytes* have been attended here with such complete success, and constantly exhibited to scientific men, in whose minds no doubt remains as to the fact, the cause of failure elsewhere may be attributed to the nature of the *barytes* used for the experiment. For some time I received from *Messrs. Allen* a substance under the name of *pure barytes*, which never exhibited any *metallic* appearance after fusion; but I have now obtained, by means of the same chemists, *barytes* answering perfectly, in all its characters, to that which I had originally employed; exhibiting, after fusion and the action of the file, a *metallic* lustre equal to any that I have before witnessed. Some *barytes* which I formerly received from *Messrs. Accum* has the same character; the only difference, as far

* See Thomson's Chemistry, fifth edition, vol. i. p. 552, Lond. 1817.

as I am able to determine, between the two substances; namely, that which deliquesces before the *gas blow-pipe*, and that which fuses into a jet-black substance exhibiting *metallic lustre*, is this; that the first has not been entirely divested of *water*. It is, in fact, a *hydrate*; and therefore any experiment made with it, for the purpose of exhibiting the *metallic nature of barytes*, must be attended with failure.

I have the honour to be, Sir, yours, &c.

Cambridge, Oct. 13, 1817.

EDWARD DANIEL CLARKE.

ARTICLE IX.

Proceedings of Philosophical Societies.

ROYAL ACADEMY OF SCIENCES.

Analysis of the Labours of the Royal Academy of Sciences of the Institute of France during the Year 1816.

MATHEMATICAL PART.—By M. le Chevalier Delambre,
Perpetual Secretary.

(Continued from p. 302.)

URANUS.

THE surprise of astronomers in 1781 will be recollected when it was announced that a planet hitherto unknown had been discovered by Herschel, the care with which they examined this new planet, and their efforts to form tables capable of representing its apparent motion. Scarcely were these tables sketched out, when astronomers discovered unexpected resources. It appeared singular that a planet which by common glasses could not be distinguished from stars of the fifth magnitude, except by a light somewhat less brilliant, should have escaped the eyes of those who have given numerous catalogues of stars even much smaller than the planet. M. Bode conceived the happy idea of looking for it in the catalogues of Flamsteed and Mayer, and of ascertaining that twice already the planet had been observed, but mistaken for a common star. The same examination into the observations of Lacaille was unsuccessful, because that astronomer made his list beforehand of the stars whose position he wished to verify from the old catalogues. Besides, he died before he had completed his catalogue of zodiacal stars, which was not published till some years afterwards. Besides these two observations of 1690 and 1755, Lemonnier published three others, one of 1764, and two of 1768. These last would have given him the honour of the discovery, if he had taken the trouble of comparing them with each other, for they were made in the

Uranus in 1715, 15 years after the first observation, and 41 years before that of Mayer. He has obtained the following results:—

4 March, right ascen.	170° 40' 18.0"	declin.	4° 54' 22.7"
10 March	170 25 45.0		5 0 38.6

The mean result is an error in the tables of $+65.7''$ in longitude, and $+1.2''$ in latitude. Besides the three observations employed above, M. Burckhardt has likewise found two others; the first, of April 2, 1712; and the other of April 29, 1715. The three observations of Lemonnier are, Jan. 15, 1764, and Dec. 27 and 30, 1768.

The opposition of 1799, compared with that of Flamsteed, gives $60.9''$ more than the tables for the motion in 84 years; for after an entire revolution, the error of the aphelion, and that of the eccentricity, are the same. We must, therefore, add $0.725''$ to the annual motion, which will be $4^{\circ} 17' 55''$. This result is the more important, because it has been hitherto impossible to separate the two indeterminate quantities.

M. Burckhardt remarks, likewise, that the observations of 1715 and 1753 are very well situated for determining the place of the aphelion; those of 1690 and 1781 are very proper for rectifying the equation of the centre.

The observations of 1690, 1715, and 1753, have given the following corrections for the tables:—

Epochs of 1799—

$$+ 34.1'' \text{ aphelion} + 6' 41'' \text{ equat.} - 55.3''.$$

The observations of 1715, 1753, and 1781, have given—

$$+ 27.5 \quad + 6.25 \quad + 3.6$$

The mean of which is—

$$+ 30.8'' \quad + 6' 33.5'' \quad - 26.8''$$

A change of six minutes in the aphelion may in certain cases change the longitude $36''$.

As for the observation of Flamsteed of 1690, which entered into the composition of the tables, the new elements represent it as only $1'$ wrong. Unfortunately, it is solitary; and it would be sufficient to read in the passage $44''$ instead of $49''$ to make the whole agree. But the manuscripts of Flamsteed are preserved at the Observatory of Greenwich. It would be easy, therefore, to determine whether the conjecture of M. Burckhardt be well founded.

M. Burckhardt then gives an easy method of comparing the new elements with all the observations which we wish to calculate. It is to add to the mean longitude of the tables $0.725'' t$, t being the number of years since 1761; to add $6' 26''$ to the aphelion, and to suppose that the tables of the equation and radius vector are for the year 1813.

The stars which Flamsteed observed at the same time Uranus are δ Leonis and b Virginis.

COMETS OF 1783 AND 1793.

The first of these comets was observed by M. Mechain, on Nov. 26, and observed by himself, as well as by M. Messier, to Dec. 21. Mr. Pigott had seen it in England from Nov. 20, and could only follow it till Dec. 3. He had only estimated the declinations, so that the uncertainty with regard to them may amount to two minutes.

Mechain, the President, Saron, and the Chevalier d'Angos, could find no parabola which came nearer than 5' or 6' of the observations at a time when the diurnal motion was only $4\frac{1}{2}'$. Such considerable errors in an arc of 25 days indicated an orbit different from a parabola, for it is proved that the observations of M. Messier agreed perfectly with those of M. Mechain.

After having tried parabolas in vain, M. Burckhardt tried an ellipse, and he found the elements as follows:—

Half the larger axis, 3·15854; sidereal revolution, five years, $7\frac{1}{2}$ months, or 2050·4 days.

Eccentricity, 0·5395345; distance of the perihelion, 1·4544.

Passage over the perihelion in 1783, 19·50013 November, astronomical time.

Place of the perihelion, $50^{\circ} 3' 8''$; ascending node, $55^{\circ} 45' 20''$.

Inclination, $44^{\circ} 53' 24''$ direct motion.

With this ellipse, the errors scarcely amount to a minute and a half.

The comparison of this ellipse with known orbits leads to the opinion that the comet of 1783 may be the same as that of 1793. It was necessary, therefore, to examine if the above ellipse would agree with this last comet.

On the supposition that the two ellipses were a little different, it would be proper to examine the effects of the attraction of Jupiter, to which the comet must have approached very near towards its aphelion. M. Burckhardt has not yet had leisure to undertake this task; but in the mean time he gives the errors of the places of the comet, calculated in an ellipse of five years, and in an ellipse of 10 years, the elements of which are as follows:—

Passage over the perihelion, 1783, Nov. 19·56868; node, $65^{\circ} 12'$; inclination, $47^{\circ} 43'$.

Perihelion, $49^{\circ} 31' 55''$; eccentricity, 0·6784; distance of the perihelion, 1·49532.

Log. $\frac{1}{2}$ greater axis, 0·6674185; log. $\left(\frac{1-e}{1+e}\right)^{\frac{1}{2}}$ 9·6412103; log. parameter, 0·3996300.

Half the greater axis, 4·64963.

The two ellipses correspond well; slight changes might still diminish the errors of the longitude; but the errors of the latitude are greater in the ellipse of 10 years. But the difference is not sufficient to prevent great uncertainty with respect to the greater

axis. Hence there is no hope of determining the perturbations with certainty.

The comet of 1793 exhibits much more troublesome uncertainties. In the first place, that comet was very weak. Chance discovered it to M. Perny when he was not looking for it. M. Messier could not see it at first with his night glass; he was obliged to employ his large achromatic telescope. He explains the reason why the comet has not been seen since, if it actually returns every 10 or every five years.

The period of the observations is 75 days. It was only 55 in 1783.

About the same time, M. Messier had himself discovered another comet, which interested him more, and to which he applied exclusively his best telescope. To observe the comet of M. Perny, he employed a telescope with a very defective micrometer, and only gave the declination within two minutes, as was afterwards known. M. Perny had a better glass, and a more exact micrometer; but he appears to have been rather negligent with respect to the passage across the wire. Hence we have good reasons for distrusting the observations of both, and it would be very difficult to decide upon the true orbit. The astronomers who were then in Paris not having leisure to calculate these observations, the President Saron, who was in prison, undertook the task, and Lalande gave him the necessary data. The parabola determined by Saron was the last labour of this respectable and unfortunate magistrate. In a note which still remains he expresses his surprise that he could only represent the observed longitudes within $16'$ or $17'$, and the latitudes within $2'$ or $4'$. We have just seen the causes; but it is just to remark, that the comet was very near the pole of the ecliptic, and that these errors reduced to the parallel of the comet become much less considerable. It is evident that errors in latitude are sufficient to ascertain that the orbit cannot be parabolic.

On the supposition that the orbit is entirely unknown, M. Burckhardt has found an ellipse, of which the elements are as follows:—

Passage, 1793, November, 28·60631; place of perihelion, $75^{\circ} 58' 58''$.

Inclination, $47^{\circ} 35' 5''$; node, $359^{\circ} 4' 48''$.

Logarithm of half the greater axis, 0·7225030; log. of the parameter, 0·3853764.

Log. of the dist. of perihelion, 0·1461360; eccentricity, 0·7347635.

Revolution, nearly $12\frac{1}{2}$ years.

This ellipse represents the last longitude only within $47\frac{1}{2}'$, and the latitude within $1\frac{1}{2}'$.

If we suppose half the greater axis known, and the revolution of 10 years, we have

Eccentricity, 0·701355; distance of perihelion, $75^{\circ} 49'$; inclination, $46^{\circ} 53'$; \log of the parameter, $0\cdot59$.

This ellipse does not represent better the observation of the 8th of December.

These observations, calculated by the method of M. Gauss, lead to a hyperbolic orbit.

The conclusion of M. Burckhardt is, that with observations so uncertain, and under similar circumstances, it is impossible to pronounce on the identity of the two comets, however probable it may have appeared at first. If the two comets constitute only one, we must suppose a considerable motion both in the node and in the perihelion of the orbit. Future observations alone can decide the question; but there are many chances that so feeble a comet may return many times to its perihelion without being perceived.

Memoir on the Agrarian Measures of the Ancient Egyptians.
By M. Girard.

It is well known that the inundations of the Nile, by destroying the boundaries of estates, obliged the Egyptians to cultivate geometry. They are even said to have been the first masters of the Greeks. It is related, indeed, that Thales taught the Egyptian priests to determine the height of the pyramids by the length of their shadows. If this be true, the geometrical science of the Egyptians was probably confined to some coarse practices of land measuring. Let us see if this new memoir throw any light on this difficult question.

“What is at present practised in Egypt is a faithful representation of what has been practised from the earliest times of civilization.” Hence the present practices will give us an idea of the knowledge that must be ascribed to the priests of that country. “It is obvious that in the measurement of lands much time would have been lost if they had measured the *aroura* (this was a square whose side was 100 Egyptian cubits in length, and whose surface was the space that two oxen could labour in a day) by applying successively a cubit measure along the length of that line. They replaced the cubit by one of its multiples. The land measurer, holding in his hand a long reed, places himself at the extremity of the line which he is going to measure. He traces with this reed a slight transverse furrow, to point out the place of that extremity. He places one end of the reed as near as possible to the ground, and traces with the other end a second transverse furrow. He places the end of the cane upon this second furrow; and thus he goes on till he has gone over the whole line. We see that this mode of measuring is as simple as possible, and scarcely requires more time than is necessary to pace over the distance to be measured; but it is obvious that it is not rigorously exact.

“Since the unit of agrarian measurement was a square of 100 cubits the side, it is obvious that the length of the cane employed in measuring must be one of the factors of this number. A reed of five cubits satisfies the essential conditions. The unity of agrarian measure of 10,000 cubits was thus transformed into another of 400 square canes.

“ To render the operations of measurement more expeditious was to solve a problem of the highest importance. The priests contrived a new cane, equally easy to employ, and having the advantage over the former of abridging the labour, without sensibly altering the value of the primitive agrarian measure.”

Such are the facts stated by the author. The following are his conjectures.

On constructing upon the diagonal of a square a new square, we see that by prolonging the sides of the primitive square, we have the diagonals of the second, and that the second was exactly double the first. We see easily that the diagonal contains more than 28 canes, and less than 29—more than 141 cubits, and less than 142. They pitched upon 28 canes. The error was only 16 superficial canes in 800; that is, a 50th part; and this error was favourable to government, because it increased the impost. The number 28 has 7 for a divisor. On that account the cane was made seven cubits long, still with the view of abridging.

It is true that we do not find in antiquity any positive evidence of the employment of the cane of seven cubits. But we can supply the place of this want of positive proof by other circumstances nearly equally strong.

The author has made several observations in his memoir on the Nilometer of Elephantine, which demonstrate that the builders of the great pyramid intended to give to the different parts of this monument a round number of linear measures. It is natural to think that the base of this pyramid ought to contain a round number of superficial measures. According to the last measurement, the surface of the base is 54135 metres, which makes exactly 10 of these septenary arouras, and gives for the cubit 0.525 metre, exactly what is deduced from the sepulchral chamber, and likewise from the nilometer at Elephantine.

We may admit very readily the singular exactness of these coincidences; but if we adopt the whole hypothesis, it would only follow from it that the Egyptian priests were acquainted with the most simple case of the famous problem of the square of the hypothenuse, which would not indicate a very advanced state of the science.

The second and third sections of the memoir treat of the agrarian measures in Egypt under the Persians and under the Romans. We see that the *jugerum* of Hero is nothing else than the Roman *jugerum*. We find it proved by a passage of Didymus of Alexandria that the Italian foot was the same as the Roman foot. All the modifications introduced into the agrarian measures are explained by this principle, which has always regulated the conduct of conquerors, to augment the sum of the impositions, attending as much as possible to the habits of the conquered people. From calculations which it is impossible for us to extract, it appears that the real size of the base of the great pyramid is only $\frac{1}{123}$ different from the value which Pliny has assigned it.

The object of the fourth section is to prove, that the Arabs introduced no sensible alteration; and the memoir terminates with the following table, which is an epitome of the whole:—

I. Primitive Aroua.

Primitive cubit	0·525 metres
Cane of five cubits	2·625
Side of 20 canes	52·50
Surface of 400 canes	2756·00
Surface of the double aroua	5512·12

II. Double Aroua of the Great Pyramid.

Cubit	0·525 metres
Cane of seven cubits	3·675
Side of 20 canes	73·50
Surface of 400 canes	5413·00

III. Double Roman Jugerum.

Cubit	0·527 metres
Cane of $6\frac{1}{2}$ cubits	3·5133
Side of the double jugerum	70·20
Surface of 400 canes	4937·00

IV. Socarion of Hero.

Cubit	0·527 metres
Royal Spirhame	0·2035
Orgye of $9\frac{1}{4}$ spir.	2·4351
Side of 10 orgyes	24·3510
Surface of the socarion	592·9710
Deusple surface	5929·7100

V. Present Feddan of the Cultivators.

Pik beledy	0·5775 metres
Cane of $6\frac{2}{3}$ pik beledy	3·8500
Side of 20 canes	77·0000
Surface of 400 canes	5929·00

VI. Present Feddan of Zobtes.

Pik beledy	0·5775 metres
Cane of $6\frac{2}{3}$ pik beledy	3·658
Side of 20 canes	73·16
Surface of 400 canes	5353·00

Theory of the Motion of Water in Capillary Tubes at different Temperatures. By M. Girard.

In presenting to the Academy an account of his experiments on the motion of water in capillary tubes, M. Girard had announced a theory capable of explaining all the phenomena. It was observed that experiments of the same nature had been made at Prague in 1796, and published in 1800, by Professor Gerstner. The memoir

of this philosopher having been communicated to M. Girard, he begins his new memoir by an analysis of the labours of the Professor of Prague. He describes his apparatus, explains the object which he had in view, and the principal results which M. Gerstner obtained. It results from this comparison, that if the two memoirs have some resemblance in certain parts, the differences between them are much more numerous, and occur in the most essential points.

M. Gerstner employed merely the empirical formula of the Chevalier Dubuat. M. Girard employs a formula, the first member of which, taken directly from a formula of Euler, expresses the accelerating forces; while the second, according to the ideas of Coulomb, expresses the retarding forces. From the equality between these two members results the uniformity of motion.

The second member $au + bu^2$ is composed of two terms, one of which depends upon the simple velocity u , the second upon the square of that velocity; a and b are constant quantities to be determined by experience.

In certain circumstances, the term proportional to the square disappears. Then the formula becomes linear, as well as the motion. The term au represents the resistance from the adhesion of the fluid to the surface along which it flows; the term bu^2 depends upon the asperities with which that surface is covered.

After these preliminaries, M. Girard undertakes the explanation of the 10 phenomena which he has observed. All that we can do is to transcribe here the enunciation of these phenomena.

1. Under any charge whatever, when the capillary tube through which the liquid runs has acquired a certain length, the term proportional to the square of the velocity disappears from the general formula of uniform motion.

2. The limit of the length at which this square disappears is so much the further from the origin of the tube the greater the charge of water above it is.

3. Every thing else being equal, the limit of the length is so much the further from the origin of the tube the greater its diameter is.

4. When the motion of the water has become linear, variations of the temperature have such an influence on the products of the flow that in the interval between 0 and 84° of the centigrade thermometer these products vary in the ratio of one to four.

5. Within the limits at which the movement begins to be linear, and when by the diminution of its length it is reduced to a simple *ajutage*, the produce of the flow varies only in the ratio of five to six for a thermometrical interval between 0° and 87°.

6. The coefficient u of the first power of the velocity varies with the diameter of the tubes employed in the experiment.

7. The coefficients a , which for tubes of different diameters have different expressions at a given temperature, approach so much the nearer to identity the higher the temperature is.

8. Whatever is the diameter of the capillary tube, the variations in the products of the flow from one degree of temperature to another are so much the more considerable the lower the temperature is.

9. The law of variability which expresses the ratio of the products of the flow to the degrees of temperature is manifested with so much the greater regularity the smaller the diameter of the tube is in which the experiments are made.

10. The temperature which exercises so great an influence on the products of uniform flow ceases to have a sensible influence when the motion takes place in open canals, or in ordinary tubes whose diameter is too great to be capillary.

The author passes to the application of his experiments to the determination of the ratio of the temperature, and the thickness of the coat of fluid adhering to the sides of the tube.

The superficies of the transverse section of the tube is diminished by a circular crown, the thickness of which varies with the temperature of the fluid. He expresses the surface of this crown by a series of this form:—

$$S = A + BT + C T^2 + D T^3 + \&c. T \text{ being the temperature.}$$

He seeks the value of the coefficients from experiment, either confining himself to T^2 , or in proceeding as far as T^3 . He deduces from this the formula of the thickness e : and by means of these two formulas he calculates the whole of the experiments made with different series of tubes, which enables him to compare these formulas with each other, and with the quantity of water which really flows out. The result of these comparisons for the first series of tubes is, that the product calculated by the formula, employing the first three powers, is greater than the product observed; and that when the third power is suppressed, and we confine ourselves to the first two, the calculated product is a little too small. But all these differences are extremely slight. From experiments made with the second series of tubes, it results that we may neglect the third power, so that the curve is only of the second degree.

These conclusions may be verified by the simple inspection of the tables, which exhibit all the circumstances of each experiment.

The author then discusses the different causes of the errors which could influence the results, and produce the slight differences remarked in them.

He thinks that we may always assign the ratio which exists between the diameter of a capillary tube, its size, and the depression of its lower orifice below the surface of the fluid in the reservoir from which it flows, and between the temperature and the flow per second when the motion has become linear.

He makes similar calculations for the thickness e of the coating for the same two series, and in the double hypothesis of the equation of the second degree and that of the third. He determines this thickness for every five degrees of the thermometer from the freezing to the boiling point. The results of these new calculations are likewise exhibited in two tables, where we remark easily that the thickness of the fluid coats which cover the inner surface of the tubes is less in the small tube than in the large. Hence the author concludes that these thicknesses do not depend solely upon the temperature, but likewise upon the radius of curvature, and the

transverse section of the tube, which would not be the case if the action of the tube did not extend to a finite distance from the surface. This remark will occasion new researches, which will be the subject of another memoir.

(To be continued.)

ARTICLE X.

SCIENTIFIC INTELLIGENCE; AND NOTICES OF SUBJECTS CONNECTED WITH SCIENCE.

I. *Arragonite.*

It has been long known to mineralogists that the crystalline forms of calcareous spar and arragonite are different; and Haüy demonstrated that no admissible decrements could reconcile their primitive forms. In the year 1813 Stromeyer announced that he had discovered in the arragonite of France $4\frac{1}{2}$ per cent. of carbonate of strontian; and in the arragonite of Spain, $2\frac{1}{2}$ per cent. of the same salt. He stated, at the same time, that he considered the crystalline shape of arragonite as the same with that of carbonate of strontian. It has been known for some years that certain substances, when they amount only to a small proportion of a compound, impress upon the whole, notwithstanding their own crystalline form. Thus two or three per cent. of sulphate of iron is capable of inducing its own form upon sulphate of zinc. White cobalt ore owes its cubic form to a small portion of iron pyrites which it contains. Gres de Fontainebleau has the crystalline form of calcareous spar, of which it contains only a small portion. Stromeyer conceived that in like manner the small proportion of carbonate of strontian in arragonite influenced the crystalline form. A short time before his death, Gehlen announced that he had met with very well-defined crystals of carbonate of strontian, and that the form was precisely the same as that of arragonite. This question has been lately discussed at great length by Professor Fuchs, of Landshut. The result of his examination is, that the crystals of carbonate of strontian have a considerable resemblance to those of arragonite, but that they are by no means the same (Schweigger's Journal, xix. 113). The crystals of carbonate of strontian found lately near Saltzburg are regular six-sided prisms. Those of arragonite are likewise six-sided prisms, but not regular; for four of the angles are of 116° , and the two others of 128° . Now M. Haüy has demonstrated that the primitive form of arragonite cannot pass into the regular hexahedron in virtue of any admissible law of decrement. Besides this, Bucholz and Meisner analyzed different specimens of arragonite, which were destitute of carbonate of strontian; and Laugier found only $\frac{1}{1000}$ th part of this salt in the arragonite of Bastenes. From these facts we may consider it as demonstrated that the opinion of Stromeyer is inaccurate. It follows, therefore, that the cause of

the discordance between the crystals of aragonite and calcareous spar is as problematical as ever.

II. Barley.

According to Proust, the constituents of barley-meal are as follows:

Yellow resin	1
Gummy and saccharine extract	9
Gluten	3
Starch	32
Hordein	55

100

The resin is obtained by digesting the meal in alcohol. It is a pitchy substance, which seems to me better entitled to the name of oil than of resin. I examined it many years ago, and was much struck with its flavour, which is precisely similar to that of spirit made from unfermented barley. Hence I was disposed to consider that flavour as owing to the presence of this oily substance.

The gummy and saccharine matter are obtained by digesting the barley-meal in cold water. The gluten precipitates in flocks when this aqueous infusion is heated.

The starch and hordein constitute the powder that remains after the preceding processes. By boiling this powder in water, the starch is taken up, while the hordein remains. The substance to which Proust has given the name of *hordein* has much the appearance of the sawings of wood, and possesses, according to him, the properties of *lignin*; or at least it approaches very closely to that vegetable principle in its properties.

III. Malt.

According to Proust, the constituents of malted barley are as follows:—

Resin	1
Gum	15
Sugar	15
Gluten	1
Starch	56
Hordein	12

100

He affirms that barley in malting loses a third of its weight (*Ann. de Chim. et Phys.* v. 342); but I can assure the reader that the whole of his account of malt and malting is very far from accurate. The average loss in more than 50 malting processes on a pretty large scale, which I myself superintended, and during which much care was taken to ensure accuracy, was only 20 per cent. The malt in these cases was weighed just when taken off the kiln, and the barley had been weighed just before it was put into the steep. I found that if the barley was kiln-dried, it lost 12 per cent. of its weight; and that the malt, when kept for some time in a granary, recovered the same proportion of weight. Hence I conceive it follows that the true loss of weight in malting does not exceed

eight per cent., or rather less than $\frac{1}{12}$ th. One half of this loss is to be ascribed to matter dissolved from the husk of the grain by the steep-water, and to grains of barley bruised and destroyed by the malster while turning the malt upon the floor; so that the real loss in malting does not, I believe, exceed four per cent. I leave it to M. Proust to decide whether it is likely that so very remarkable a change should be produced in the composition of barley-meal by malting, and yet so small a change in the weight. The hordein of Proust I consider as starch in a particular state, somewhat similar to the fibrous matter of potatoes. The malting partly converts it into the state of sugar, and partly into that of common starch, by destroying a certain unknown glutinous substance which glues the particles of it so firmly together.

IV. *Brewing.*

M. Proust's notions of brewing by means of barley and malt are obviously very imperfect. He says the great product of the fermentation is carbonic acid. The fact is, as I have determined by numerous experiments upon a large scale, that the portion of malt which is dissolved is resolved by fermentation into nearly equal weights of carbonic acid and alcohol of the specific gravity 0.825. When raw grain is employed by the distillers, it undergoes, while in the mash tun, a change similar to that induced on barley by malting; for the wort is just as sweet-tasted as the wort from malt.

V. *Effect of Lightning on a Tree.*

(To Dr. Thomson.)

SIR,

George-street, Edinburgh, July 23, 1817.

In my walk two days ago I happened accidentally to step into Craiglockart Garden, near the village of Slateford, about two miles west of Edinburgh, where, after inspecting the garden, hothouses, and romantic grounds, upon the wooded banks of the water of Leith, the keeper informed me that the thunder-storm of the 10th ult. had been particularly terrible at that spot, that the lightning had struck a tree on the side of the highway to the north of the garden wall, and had afterwards struck a man who had taken shelter in a neighbouring outhouse attached to the back of the garden, near the tree.

Wishing to ascertain the appearance of a tree struck with electric fluid (having often observed large blotches on the bark of trees said to have been caused by the lightning), I requested the keeper (Mr. Robertson) to show me the tree. I found it to be an English elm. The lightning had struck it at a small decayed knob about 15 feet above the ground, on the north side of the tree. It descended all round in a spiral form, and went off from the ground, destroying a large quantity of nettles and grass at the root of the tree in a south-west direction, towards the house where the man had taken shelter, where at the root of the tree I observed it had torn up the earth, which is still quite apparent, from the root of the tree, in the shape nearly of a large grooved wheel track, diminishing in size as it ex-

tends outward. From this it entered the outhouse where the men were, and struck one of them so much that he was quite stupified for some time; and afterwards, as the men relate, the lightning went off by a skylight, although there is no visible mark of its course after quitting the root of the tree, and the grooved way, which does not extend above two feet from the tree, but is in the direction of the door of the house. In this house there was a considerable quantity of iron. Thus it would appear that leading a conductor to the earth is no certain rule of safety—the lightning does not descend into the ground.

The appearance of the effects of the fire upon the tree is quite different from the blotches which, in my ignorance, had frequently been passed upon me for the effects of lightning, and which probably is some disease of the tree, or animalculæ. The appearance of this tree is as if the top knobs of the outer cortex had been touched with a wright's plain, having a white glistening colour, as if after friction. No black traces remained upon the tree, and nothing bore the resemblance of burning, except some lateral branches, and the nettles and brushwood at the bottom of the tree.

The most surprising fact, however, is, that four years ago two trees (within a few yards of the elm that was struck) were in like manner successively struck with lightning. The one tree was a beech, and is now cut down, having decayed by the effects of the lightning: the other a fir, I believe, which remains a wretched spectacle to this day. This led me to inquire as to the contiguous metals imbedded in the ground under the spot.

Fortunately a well about 18 feet deep is sunk close by, which a man informed me he had been at the bottom of, and he assured me that the only mineral cut through in that depth was a greyish free-stone.

I have thought it proper to set down this information for you as I received it, and saw it. And if it can throw any light, or afford any hints to your learned friends, upon this most awful phenomenon of nature, I shall be happy. The shape of the groove by which the electric fluid escaped from the tree may perhaps be some foundation for ascertaining the form of the forked lightning. And from the direction as marked on the ground, and the circumstance of the man being so sensibly affected in the outhouse, it would appear to have been the same flash that did both.

I have the honour to be, Sir,

Your most obedient, humble servant,

JOHN GOVAN.

VI. Register of the Weather at New Malton, in Yorkshire.

July, 1817.—Mean pressure of barometer, 29·518; max. 29·83; min. 28·75. Range, 0·88 in. Spaces described by the curve, 5·00 in. Number of changes, 13.—Mean temperature, 58·92°; max. 70°; min. 48°. Range, 22°.—Amount of rain, 4·05 in. Wet days, 22. Prevailing winds, Westerly. N, 3. NE, 2. E, 1.

SE, 1. S, 6. SW, 7. W, 7. NW, 3. Var., 1. Brisk winds, 3. Character of the period: wet, cold, and cloudy.

August.—Mean pressure of barometer, 29.492; max. 29.92; min. 28.80. Range, 1.12 inch. Spaces described by the curve, 7.30 in. Number of changes, 20.—Mean temperature, 56.60°; max. 70°; min. 42. Range, 28°.—Amount of rain, 5.47 inch. Wet days, 25. Prevailing wind, SW. NE, 3. SE, 2. S, 6. SW, 13. W, 1. NW, 2. Var., 4. Brisk winds, 12. Boisterous, 6.

This period was so uncommonly wet, that scarcely a single day elapsed without rain, either in greater or less quantities, and often accompanied with very heavy gales, the amount being equal to nearly 5½ inches. The barometrical column, as may be seen from the number of changes in its direction, was in continual fluctuation, and the mean lower than for some time past.

September.—Mean pressure of barometer, 29.772; max. 30.14; min. 28.69. Range, 1.45 in. Spaces described by the curve, 6.12 in. Number of changes, 15.—Mean temperature, 55.43°; max. 71°; min. 30°. Range, 41°.—Amount of rain, 1.05 in. Total quantity this year, 20.32 in.—Prevailing wind, easterly. N, 4. NE, 7. SE, 5. S, 8. SW, 1. W, 3. NW, 1. Var., 1. Brisk winds, 3. Boisterous, 2.

A violent storm of thunder, vivid lightning, and heavy rain, between three and four, a. m. on the 4th, closed a series of wet and changeable weather of above three months' duration. The air now become serene and mild, with very little rain for the remainder of the period. When the moon attained her full on the 25th, a succession of heavy equinoctial gales from the S and SW were experienced, which considerably depressed both the pressure and temperature; the thermometer indicating 32° on the 30th, and 30° on the following morning.

New Malton, Oct. 3, 1817.

J. S.

VII. *Kidney Bean and Common Bean Perennials.*

(To Dr. Thomson.)

SIR,

Should you deem the following facts worthy a place in your Journal, I shall feel myself much honoured,

And am, with due respect,

Sir, your very obedient servant,

Cork, Sept. 18, 1817.

THOMAS HOLT.

It is a generally received opinion, supported by the authority of all the botanical and horticultural works I have had opportunity of consulting, that the *phaseolus vulgaris*, or common kidney bean, and the *phaseolus nanus*, or dwarf kidney bean, are annual plants. Experience has taught me that they are both perennials, as well as the *fabia vicia*, or common garden bean, with its varieties. How the fact could have escaped the penetrating eye of the late Philip Millar, I cannot determine; but in his *Botanical Dictionary* they

are all pronounced *annual* plants. Of course the botanical works of more recent date, being chiefly abridgments, selections, and *improvements*, of that book, have maintained the same opinions.

The fact is readily proved. In the month of September or October, on the appearance of any sharp frosts, or when the beans have done bearing, let them be cut down within two inches of the soil; shake over the roots some litter from a stable; and about the May following the roots will throw up fresh shoots, which will be stronger, and more vigorous, than those of the first year's growth. This I have repeated with never-failing success for these six years past, in the course of which I have observed that the bean pods do not come to maturity so early by about three weeks in the second or succeeding years as they do the first year's growth; but that the second year's crop is not so liable to be injured by variable weather, frosts, or wet, as the fresh sown plants; and that the roots are more in danger of injury from cold rains in winter than by hard frosts.

At the same time I must request permission to correct a misstatement of a fact which appeared in Mr. Sym's paper on Flame, which appeared in the *Annals of Philosophy* for November last. The author observes, "*for flame is an opaque substance, as any one may satisfy himself by trying to read a book through the upper part of the flame of a candle.*" (Vol. viii. pp. 322, 323.) I have repeatedly tried the experiment; and have satisfied myself that a book of very small print may be easily read through any part of the flame of a candle, and indeed of any other not intensely bright flame, if held a short time behind it, with the eye fixed on it.

VIII. Royal Geological Society of Cornwall.

Annual Report of the Council.—In performing this annual duty, the Council acknowledge with pleasure the liberal contributions of mineral specimens, to which the increased splendour of the cabinets is so greatly indebted; and they contemplate with peculiar satisfaction the spirit of investigation, and activity in research, which continue to animate the members of the society, and to augment that interesting department of the collection which is calculated to illustrate the geological structure of the county.

In consequence of such an increase in the number of specimens, as well as in that of the members of the society, the present room has been found inadequate to its purposes, a museum has therefore been erected, which will prove better adapted for the meetings, and more favourable to the enlarged views and increasing prosperity of the institution.

The Council have to lament the unfavourable state of the weather during the preceding year, as it has unfortunately retarded the progress of those investigations which are necessary for the completion of the geological map of the county; and they beg to remind the members of the society that to obtain this desirable object, their social and united exertions are required, and they more especially solicit the co-operation of those gentlemen who are resident in the *more remote districts* of the county.

The Council beg to direct the attention of the Society to the very interesting and instructive series of specimens collected from the different mines, at different levels, by Joseph Carne, Esq. in illustration of the history of that rock to which the name of *Elvan* has been provincially given. It is hoped that similar suites of the other metalliferous rocks will be collected, with a view to discover their geological relations.

Mr. Chenhalls reports that the safety bar continues in use in all the western mines, without any objection; and that not a single accident has occurred for two years. This testimony of its value, together with the strong address of Mr. Justice Abbot, and the resolution of the Grand Jury at the last Lent Assizes, in favour of its speedy and general introduction, cannot fail to eradicate any prejudice which might exist against it.

Comparative View of the Number of Members at the last and on the present Anniversary.—Last anniversary, 153; withdrawn and dead, 5; elected this year, 18; total, 166.

The Secretary reports that the first volume of Transactions is in the progress of printing.

The following papers have been read since the last Report:—

1. On the Processes for making the different Preparations of Arsenic which are practised in Saxony, and on those for preparing Smalt or Cobalt as pursued in Bohemia; presented to the Society in the hope of introducing similar establishments in Cornwall; by John Henry Vivian, Esq. M.G.S.C.

2. Notice relative to the Formation of a mineral Substance known by the Name of Swimming Quartz; by Joseph Carne, Esq. M.G.S.C.

3. On the Discovery of Gregorite in large Quantities in a Stream at Lanarth, in the Parish of St. Keverne; by John Ayrton Paris, M.D. F.L.S. Hon. Mem. G.S.C. &c.

4. A Sketch of the Plan of the Mining Academies of Freyburg and Schemnitz, and on the Advantages which would attend the Establishment of a School of Mines in Cornwall; by John Henry Vivian, Esq. M.G.S.C.

5. On the Nature and Quantity of the different Rocks and Clays annually exported from the County of Cornwall, for the Purposes of Architecture, Manufactures, and the Arts; by John Ayrton Paris, M.D. F.L.S. Hon. Mem. G.S.C. &c.

6. On the Circulation of printed Queries respecting Lodes through the Mines of Cornwall; by John Hawkins, Esq. F.R.S. M.G.S. L. and C.

7. On the History of Sub-marine Mines; by John Hawkins, Esq. F.R.S. M.G.S. L. and C.

8. On the Salt Mines of Poland; by John Henry Vivian, Esq. M.G.S.C.

9. On the Lodes of Polgooth; by John Hawkins, Esq. F.R.S. M.G.S. L. and C.

10. On the Introduction of the Cornish Miners, into the Silver

Hawkins, Esq.

Corps of
with an

Account of the Arrival and singular Reception of Mr. Trevithick, the Engineer; by Henry Boase, Esq. Treasurer.

11. A Notice respecting the Discovery of Phosphate of Iron, at Huel Kine, in St. Agnes, and on the Circumstances under which it was discovered; by Joseph Carne, Esq. M.G.S.C.

12. On the Art of refining Tin; by John Hawkins, Esq. F.R.S. M.G.S. L. and C.

13. An Account of the Quantity of Tin produced in Cornwall in the Year ending with Midsummer Quarter, 1817; by Joseph Carne, Esq. M.G.S.C.

14. An Account of the Produce of the Copper Mines in Cornwall, in Ore, Copper, and Money, for the Year ending June 30th, 1817; by Joseph Carne, Esq. M.G.S.C.

15. An "Eloge" upon the Life and Scientific Labours of the late Rev. William Gregor; by John Ayrton Paris, M.D. F.L.S. Hon. Mem. G.S.C.

At the anniversary meeting, Sept. 16, 1817, Davies Gilbert, Esq. M.P. F.R.S. President, in the Chair, the Report of the Council being read, it was resolved,

That it be printed and circulated:

That the thanks of the Society be presented to John Hawkins, Esq. John Henry Vivian, Esq. Joseph Carne, Esq. Henry Boase, Esq. and John Ayrton Paris, M.D. for their communications; and that the *Eloge* upon the Rev. William Gregor be immediately printed.

The following Resolutions, proposed by Davies Gilbert, Esq. M.P. President, and seconded by Sir Christopher Hawkins, Bart. were unanimously passed:—

Resolved—That Dr. Paris is entitled to the warmest thanks of this Society, and of the county of Cornwall, for originating the plan, and promoting the institution, of the Royal Geological Society, which renders our home the school of science, and our native riches increasing sources of prosperity, whilst it has cleared the laborious path to them of its peculiar perils.

Resolved—That, as he has left in this institution so ample a memorial of himself, he ought not to be permitted to depart without a lasting memorial of us.

Resolved—That a valuable piece of plate, with an inscription expressive of his merits, and of our grateful sense of them, be presented to him; and that Davies Gilbert, Esq. M.P. Sir Rose Price, Bart. the Rev. C. V. Le Grice, Thomas Boltho, Esq. and Joseph Carne, Esq. be appointed a Committee for carrying the said Resolution into effect.

IX. Remarkable Action of Paste on Cast-Iron.

(To Dr. Thomson.)

SIR,

In the *Annals of Philosophy* of last month (p. 302) you have noticed the remarkable action of paste on the cast-iron cylinders

employed in weaving cotton; and you conjecture that the substance resembling in appearance plumbago is formed by the development of an acid—unquestionably acetic. In confirmation of this opinion, I beg to observe that the very same kind of substance is produced by distilling pyroligneous acid (which is identical with vinegar) in cast-iron vessels. I have remarked that, after the vessels have been some time in use, their interior becomes so very soft, that with a common pocket knife they may in a few minutes be almost entirely cut through. In this instance, and in that related by you, as mentioned above, the formation of fictitious plumbago may be regarded as proceeding from the action of vinegar; but, in the instance related by Dr. Henry, in an early number of your *Annals*, the partial conversion of iron into this substance has undoubtedly a different origin.

I am, Sir, yours most respectfully,

Chester, Oct. 14, 1817.

S. LEET.

ARTICLE XI.

Scientific Books in hand, or in the Press.

Dr. Armstrong, of Sunderland, is about to publish a work on *Scarlet Fever, Measles, Consumption, &c.* His volume on *Typhus Fever* is also reprinting, with considerable additions.

Dr. Adams is about to publish a *New Edition of his Life of Mr. John Hunter.*

Mr. Thomas Forster has just published a work, entitled, *Observations on the casual and periodical Influence of peculiar States of the Atmosphere on Human Health and Diseases, particularly Insanity.* The object of this work is to point out and illustrate the connexion between the periodical changes in the electricity of the atmosphere and the periods of diseases.

The same Author has likewise published *Observations on the Phenomena and Treatment of Insanity*, being a Supplement to the former. In this work the Author has shown the particular application of the foregoing doctrine to the treatment of madness, and has adduced numerous proofs of the safety of the lowering regimen in that disease.

The Manuscripts of the late Mr. Spence, of Greenock, were some time ago submitted to Dr. Herschel, who has selected the most complete for publication. The students of pure mathematics will be gratified to hear that the volume now preparing for publication contains, besides the ingenious *Essay on Logarithmic Transcendents*, unpublished Tracts on the same class of the science, equally new and elegant. A *Biographical Sketch of the Author*, by his friend Mr. Galt, will be prefixed to the volume.

Mr. Jones, Optician, is about to publish the late Mr. Ferguson's *Astronomical Planisphere of the Heavens; showing the Day of the Month; Change and Age of the Moon; Places of the Sun and Moon, and Stars of the first, second, and third magnitude; likewise his Astronomical Rotula, showing the Course of the Moon, the Motion of the Sun, Moon and Node of the Moon, and Lunar Eclipses, from 1817 to 1864, with Directions for observing them. The Calculations are continued by the Rev.*

ARTICLE XII.

Magnetical and Meteorological Observations.

By Col. Beaufoy, F.R.S.

Bushey Heath, near Stanmore.

Latitude 51° 31' 43" North. Longitude west in time 1' 20.7".

Magnetical Observations, 1817. — Variation West.

Month.	Morning Observ.			Noon Observ.			Evening Observ.		
	Hour.	Variation.		Hour.	Variation.		Hour.	Variation.	
Sept. 1	8 ^h 35'	24° 32'	50"	1 ^h 35'	24° 42'	33"	6 ^h —	—	—
2	8 35	24 32	56	1 30	24 42	32	6 35	24 33	50
3	8 40	24 32	23	1 40	24 42	04	6 40	24 35	17
4	8 35	24 31	59	1 45	24 42	31	6 35	24 34	54
5	8 40	24 33	30	1 30	24 41	58	6 45	24 34	28
6	8 45	24 33	12	1 35	24 40	53	6 40	24 35	05
7	8 40	24 33	40	1 40	24 41	43	6 30	24 34	34
8	8 40	24 32	52	1 35	24 42	36	6 40	24 35	18
9	8 35	24 32	52	1 35	24 41	41	—	—	—
10	8 40	24 34	02	1 45	24 40	00	6 30	24 35	32
11	8 35	24 33	58	1 35	24 40	53	6 30	24 35	27
12	8 35	24 33	39	1 35	24 42	07	6 30	24 35	00
13	8 35	24 33	06	1 35	24 43	42	6 30	24 35	24
14	—	—	—	1 45	24 40	04	6 20	24 35	12
15	8 30	24 32	54	1 35	24 43	39	6 20	24 35	21
16	8 40	24 41	55	1 35	24 44	16	—	—	—
17	8 35	24 33	45	1 40	24 42	53	—	—	—
18	8 35	24 34	19	1 40	24 41	23	6 10	24 34	25
19	8 35	24 32	10	1 30	24 41	37	6 20	24 46	51
20	8 35	24 33	26	1 35	24 38	18	6 15	24 34	43
21	9 35	24 33	14	1 40	24 38	58	6 10	24 35	21
22	8 35	24 32	20	—	—	—	6 05	24 34	20
23	8 35	24 34	56	1 35	24 40	38	6 05	24 32	45
24	8 35	24 32	10	1 35	24 41	58	6 05	24 34	35
25	—	—	—	1 35	24 41	54	5 50	24 33	54
26	8 35	24 31	54	1 35	24 40	50	5 55	24 33	06
27	8 35	24 32	02	—	—	—	5 55	24 35	03
28	8 35	24 34	14	1 50	24 41	51	—	—	—
29	8 40	24 31	14	1 40	24 40	21	5 50	24 33	35
30	8 35	24 32	13	1 55	24 40	58	5 55	24 34	27
Mean for the Month.	8 36	24 33 02		1 38	24 41 36		6 19	24 34 38	

The morning observation on the 16th, and the evening observation on the 19th, are rejected in taking the mean, being so much in excess, for which there was no apparent cause.

Meteorological Table.

Month.	Time.	Barom.	Ther.	Hyg.	Wind.	Velocity.	Weather.	Six's.
Sept.		Inches.				Fect.		
1	Morn....	29.608	57°	72°	SSE		Cloudy	47
	Noon....	29.630	63	45	WSW		Fine	65
	Even....	—	—	—	—		—	—
2	Morn....	29.628	58	60	E		Very fine	50
	Noon....	29.590	66	50	ESE		Hazy	67
	Even....	29.535	61	70	E by S		Cloudy	57
3	Morn....	29.500	63	65	ESE		Very fine	57
	Noon....	29.480	74	46	SE by E		Clear	75
	Even....	29.515	68	52	ESE		Clear	58
4	Morn....	29.620	59	73	NW		Cloudy	58
	Noon....	29.667	69	43	NW		Very fine	70
	Even....	29.745	63	52	W by N		Very fine	54
5	Morn....	29.765	61	65	NNE		Very fine	54
	Noon....	29.770	71	47	NW		Very fine	72
	Even....	29.755	62	57	Calm		Very fine	55
6	Morn....	29.713	62	54	SSW		Very fine	55
	Noon....	29.700	70	44	WSW		Very fine	72
	Even....	29.700	62	51	Calm		Very fine	56
7	Morn....	29.713	62	63	E		Very fine	56
	Noon....	29.700	71	49	E		Very fine	72
	Even....	29.662	63	48	E		Very fine	53
8	Morn....	29.585	62	75	E		Very fine	53
	Noon....	29.555	73	47	Var.		Very fine	75
	Even....	29.555	66	52	E		Very fine	56
9	Morn....	29.643	57	75	N		Foggy	65
	Noon....	29.650	62	66	N		Foggy	65
	Even....	—	—	—	—		—	—
10	Morn....	29.620	56	76	NNE		Foggy	55
	Noon....	29.600	60	68	NNE		Cloudy	61
	Even....	29.585	56	73	N		Fine	53
11	Morn....	29.625	56	92	ENE		Foggy	53
	Noon....	29.625	61	77	ENE		Foggy	63
	Even....	29.600	60	72	NE		Cloudy	54
12	Morn....	29.525	56	83	ESE		Foggy	54
	Noon....	29.473	65	54	SW by S		Cloudy	66
	Even....	29.510	60	59	WSW		Cloudy	49
13	Morn....	29.583	54	60	NE		Fine	49
	Noon....	29.583	62	50	ENE		Cloudy	63
	Even....	29.564	56	67	ENE		Rain	55
14	Morn....	—	—	—	—		—	—
	Noon....	29.490	59	78	NE		Rain	60
	Even....	29.507	59	79	NE		Misty	58
15	Morn....	29.594	61	86	ENE		Drizzle	58
	Noon....	29.634	65	74	ENE		Moist	65
	Even....	29.653	62	79	ENE		Moist	60
16	Morn....	29.660	62	82	ESE		Foggy	60
	Noon....	29.660	65	69	E		Cloudy	67
	Even....	—	—	—	—		—	—
17	Morn....	29.600	58	78	ENE		—	55
	Noon....	29.534	68	55	ENE		—	—
	Even....	—	—	—	—		—	—

Meteorological Table continued.

Month.	Time.	Barom.	Ther.	Hyg.	Wind.	Velocity.	Weather.	Sixt.	
Sept.		Inches.				Feet			
	18	Morn....	29-273	58°	74°	NE		Showery	59
		Noon....	29-237	62	60	NE		Fine	62
	19	Even....	29-260	57	75	N		Showery	55
		Morn....	29-430	57	75	W by N		Foggy	
	20	Noon....	29-485	60	60	W		Cloudy	62
		Even....	29-555	57	70	W		Fine	51
	21	Morn....	29-605	56	64	NW		Fine	
		Noon....	29-610	61	57	W by N		Cloudy	
	22	Even....	29-625	57	60	WNW		Cloudy	54
		Morn....	29-575	55	76	NE by N		Cloudy	
	23	Noon....	29-564	61	56	NE by N		Cloudy	63
		Even....	29-530	56	58	NE		Fine	45
	24	Morn....	29-465	51	69	NE		Very fine	
		Noon....	—	—	—	—		—	
	25	Even....	29-437	54	53	NE		Cloudy	49
		Morn....	29-488	54	70	NNE		Cloudy	
	26	Noon....	29-466	62	52	NE		Fine	64
		Even....	29-480	58	62	NE		Fine	50
	27	Morn....	29-548	54	73	Calm		Cloudy	
		Noon....	29-540	61	55	S		Hazy	
	28	Even....	29-468	55	57	S		Fine	52
		Morn....	—	—	—	—		—	
	29	Noon....	29-110	61	51	SW		Cloudy	63
		Even....	29-050	58	58	SW by S		Drizzle	54
	30	Morn....	28-787	57	67	SSW		Stormy	
		Noon....	28-790	60	49	SSW		Stormy	
	31	Even....	28-840	51	55	WSW		Stormy	48
		Morn....	28-958	53	55	SW		Cloudy	
	32	Noon....	—	—	—	—		—	55
Even....		28-985	48	65	W by S		Cloudy	45	
33	Morn....	29-285	47	65	W by S		Cloudy		57
	Noon....	29-367	56	43	W by N		Fine		
34	Even....	—	—	—	—		—	39	
	Morn....	29-580	46	63	W		Cloudy		
35	Noon....	29-580	56	43	W by N		Fine	57	
	Even....	29-580	51	50	SSW		Cloudy	45	
36	Morn....	29-518	47	58	NE		Showery		56
	Noon....	29-537	55	46	ENE		Fine		
37	Even....	29-537	49	49	ENE		Cloudy	56	

ARTICLE XIII.

METEOROLOGICAL TABLE.

1817.	Wind.	BAROMETER.			THERMOMETER.			Hygr. at 9 a. m.	Rain.
		Max.	Min.	Med.	Max.	Min.	Med.		
9th Mo.									
Sept. 3	S E	29.96	29.79	29.875	75	53	64.0	65	C
4	Var.	30.10	29.96	30.030	69	43	56.0	63	
5	Var.	30.10	30.03	30.065	73	46	59.5	60	
6	Var.	30.03	30.00	30.015	63	47	55.0	59	
7	S E	30.03	29.91	29.970	71	44	57.5	60	
8	E	30.07	29.94	30.005	76	47	61.5	58	
9	N E	29.96	29.94	29.950	66	54	60.0	63	
10	N	29.97	29.92	29.945	65	50	57.5	59	
11	N E	29.92	29.87	29.895	68	49	58.5	65	
12	Var.	29.93	29.80	29.865	68	49	58.5	62	—
13	S E	29.93	29.85	29.890	66	53	59.5	56	—
14	N E	29.93	29.83	29.880	63	56	59.5	63	0.17
15	N E	29.98	29.93	29.955	66	60	63.0	64	
16	S E	29.98	29.94	29.960	72	51	61.5	63	
17	N E	29.94	29.61	29.775	70	54	62.0	60	D
18	N	29.76	29.56	29.660	62	55	58.5	62	4
19	W	29.95	29.76	29.855	67	47	57.0	57	
20	N W	29.95	29.91	29.930	64	55	59.5	53	
21	N E	29.91	29.83	29.870	63	42	52.5	61	
22	N E	29.83	29.80	29.815	59	47	53.0	53	
23	N E	29.90	29.80	29.850	64	47	55.5	52	
24	S E	29.90	29.52	29.710	66	47	56.5	51	
25	S W	29.52	29.16	29.340	64	55	59.5	65	—
26	S W	29.31	29.16	29.235	60	47	53.5	58	0.20
27	S W	29.65	29.31	29.480	58	44	51.0	48	7
28	W	29.95	29.65	29.800	59	33	46.0	55	
29	N W	29.95	29.89	29.920	58	43	50.5	54	
30	N E	29.89	29.75	29.820	55	42	48.5	53	
10th Mo.									
Oct. 1	N W	30.02	29.75	29.885	56	30	43.0	57	
2	N	30.05	30.02	30.035	46	24	35.0	48	
		30.10	29.16	29.842	76	24	55.76	58	0.48

The observations in each line of the hours, beginning at 9 A. M. on the day denotes, that the result is included in it

to a period of twenty-four the first column. A dash denotes, that the result is included in it

REMARKS.

Ninth Month.—3. Much dew: very fine day, with *Cirrus* only, in horizontal striz: temp. 72° after sun-set. 4. Dew: fine morning: *Cirrocumulus*, followed by cloudiness from S about nine: clear afterwards, save a line of low thunder clouds in the NE. 5. Fine, after misty morning: large *Cumuli*: at night the floating dust and smoke assumed the horizontal arrangement usual before the *Stratus*. 6. Misty morning: afterwards large plumose *Cirri*, passing to *Cirrocumulus*: p. m. some delicate streaks of *Cirrostratus*, with two currents near the earth at sun-set, SW above E. 7. Serene day, after misty morning: a very luminous, yellowish, evening twilight, with crimson streaks of *Cirrocumulus*, and a dew haze round the horizon. 8. As yesterday, with *Cirri*, finely tinted in orange at sun-set. 9. Overcast, a. m.: at sun-set, *Cirrostrati* from SE. 10. Overcast morning: then *Cumuli*, and with an electrical character: a fine breeze these three days. 11. Calm, misty morning: then lightly clouded till evening. 12. Misty morning: after a little rain, the sky exhibited a veil of clouds moving from the SW. 13. *Cumulostratus* through the day. 14. Rain very early: temp. 68° at nine, a. m.: mild and damp air. 15. Cloudy, close, damp, day and night. 16. Overcast, with a breeze. 17. Misty morning: then sunshine and flying clouds. 18. Slight showers, with wind. 19. Cloudy morning: luminous evening twilight, orange, with rose colour above. 20. Clear dewy morning: the temp. scarcely varied from 55° through the night: *Cumulus*. 21—23. Fine, with breeze pretty strong, and various clouds. 24. The approach of the westerly current from the southward was indicated to-day by the southing of the wind, by heavy *Cumuli* and *Cumulostrati* in the SE, and by a lurid haze, with greenish streaks of *Cirrostrati*, before the moon. 25. A gale from SW, with light rain: in the evening lunar corona with the *Nimbus*: heavier showers in the night. 26. Showery morning: then *Cumuli* carried in a fine blue sky: evening showery: night windy. 27. Wind and showers. 28. The morning gradually cleared up, with *Cirrostratus* passing to *Cirrocumulus*, and some very elevated *Cirri*: at sun-set these showed red, stretching SW and NE. 29, 30. The wind, after going to SW for a short time, came round by N to NE, with fine weather.

Tenth Month.—1. Fine: very red *Cirri* at sun-set. 2. Hoar frost, with ice.

RESULTS.

Winds Easterly, interrupted after the full moon by a gale from the westward.

Baremeter: Greatest height..... 30·10 inches,
 Least 29·16
 Mean of the period 29·842

Thermometer: Greatest height..... 76°
 Least 24
 Mean of the period..... 55·76

Mean of the Hygrometer..... 58

Rain..... 0·48 inch.

TOTTENHAM, *Tenth Month*, 23, 1817.

L. HOWARD.

ANNALS
OF
PHILOSOPHY.

DECEMBER, 1817.

ARTICLE I.

Biographical Account of William Brownrigg, M.D. F.R.S.
By Joshua Dixon, M.D.

(Concluded from p. 338.)

IN four lemmas, introductory to his account of the improvements proposed in the art of preparing white salt, Dr. Brownrigg shows, by indisputable facts and arguments, that white salt obtained by the usual methods is inadequate to the purposes to which it should be applied; that it is not calculated for the preservation of provisions; and that it assists, rather than prevents, putrefaction. The dissipation of the volatile acid in large quantities, in consequence of the violent heat used in the process; the mixture of calcareous and ferruginous earths, of heterogeneous salts, of sulphureous substances, and of impurities occasioned by the several additions to white salt; appear, from accurate experiments, the sole cause to which its evident defects can be ascribed. As a remedy for these defects, Dr. Brownrigg proposes two methods of obtaining salt superior in strength and purity to every other kind: first, by a more complete impregnation of it with its acid; and, secondly, by a more perfect separation of its impurities. According to the plan which he suggests, a kind of white salt may be prepared, either from sea water, natural brine, or rock salt dissolved in weak brine, or sea water. The construction of the salt marsh should correspond to that adopted in France, and the size of the boiler should be the same as what is used by the Dutch; the clarification of the brine is to be effected by the mixture of whites of eggs, and the alkaline

salt of the brine to be neutralized by the addition of a proper quantity of sour whey. The violent boiling which he recommends in this part of the process cannot occasion any considerable dissipation of the acid, as experiments discover that no portion of it is separated until one-third of the water is exhaled. The salt thus prepared, though sufficiently adapted to culinary purposes, may yet further be improved by the following expedients. By the addition of such a quantity of pure spring water as may be sufficient to dissolve the salt and produce a strong brine, a sediment will be deposited at the bottom of the vessel. A slow evaporation of this clear solution of white salt must then be promoted by a gentle, equal, and regular heat; and, on the first appearance of crystallization, such a proportion of muriatic acid must be mixed with the salt as may prevent the ascendancy of either the acid or alkali. The salt remaining after the evaporation is completed will surpass in purity, strength, and efficacy, every other preparation. Though the expenses attending this process can only be ascertained and determined by proper experiments; yet, from Dr. Brownrigg's calculations, it is probable that the price of this refined salt would be less than that of common bay salt, and would not exceed that of common white salt. He concludes this ingenious and elaborate publication by recommending the interference of the Legislature in directing a more comprehensive inquiry into the practicability of the improvements proposed; in erecting salt-works for the purpose of making additional and more accurate experiments; in appointing skilful and judicious persons to the inspection and superintendance of them; and in regulating the price and quality of salt by one common and established standard.

The superior advantages of the processes which have been explained over that of Mr. Lowndes must be sufficiently obvious, inasmuch as the latter is confined entirely to boiled brine salt, whilst Dr. Brownrigg suggests improved methods of obtaining both bay and white salt. Mr. Lowndes's process, likewise, can neither be admitted as perfect and unexceptionable, nor, with justice, can it be considered as his exclusive discovery. The addition of the alum, which constitutes its chief peculiarity, had long before been practised in Cheshire; and, in all probability, the uniform and moderate heat used in the preparation of the salt was solely instrumental in producing those effects which were improperly attributed to the alum.

This work was so highly approved by the Royal Society, that they conferred upon Dr. Brownrigg the singular honour of directing an abridgment of it to be made by Mr. William Watson, a most worthy member of that establishment, which they published in the 46th volume of their Transactions. His improvements in the salt-pans and furnaces have been adopted in the Cheshire and Droitwich salterns, and in many other parts of the kingdom. In consequence, a stronger and purer boiled salt than that which was formerly made is now prepared at all the British salt-works, and the demand for

their salt was greatly increased, especially before the North American war.

To this judicious and valuable publication the late celebrated Professor of Chemistry in the University of Edinburgh, Dr. Joseph Black, when explaining in his lectures the art of preparing and preserving common salt, always made a particular reference, respectfully intimating that the ample instructions there given superseded the necessity of expatiating on the subject. Subsequent writers, also, who have pursued the same track of inquiry, whilst they unanimously acknowledge their obligations to Dr. Brownrigg, mention his labours in terms of praise which reflect equal honour on his talents and their own judgment.*

The metal platina di pinto, juan blanco, or white gold, was the next object of Dr. Brownrigg's attention. The first specimens of this article, having been originally carried from Carthage, in New Spain, to Jamaica, were brought to England in 1741, by Mr. Charles Wood, a skilful and inquisitive metallurgist. They were given by him to his relation Dr. Brownrigg, who presented them to the Royal Society in 1750, accompanied with an accurate and ingenious account of its origin and properties, which was inserted in the 46th volume of their Philosophical Transactions, under the title of Several Papers concerning a new Semimetal† called Platina. The specimens were, first, those of its ore in a natural state; secondly, when purified; thirdly, when fused; and, lastly, as forming part of the pommel of a sword.

Don Antonio d'Ulloa, a Spanish mathematician, had in the year 1748 slightly mentioned this intractable metallic stone, as he improperly terms it; which is represented as preventing the separation of gold from its ore. Dr. Brownrigg, however, is entitled to the credit of having communicated to the public the earliest scientific information respecting it. He introduces the subject with observing that naturalists yet remain unacquainted with a great variety of mineral substances; and that, of those already discovered, there are many species whose properties are imperfectly known. After comparing the specific gravity of gold with that of mercury and platina, he notices the singular qualities of the latter, and proves from them that it is in many respects an exception to certain axioms admitted in metallurgy. Platina, he observes, is not found in the form of a pure ore, but in the state of dust or grains, blended with ferruginous impurities, which are easily attracted and separated by the magnet. He next mentions the manner of obtaining it, its

* Dr. Campbell, in his Political Survey of Great Britain, noticing Dr. Brownrigg's treatise upon salt, calls it "a very learned, ingenious, and solid performance; than which," he adds, "there is not perhaps any thing more concise or more correct in any language." This eulogium from one who was well qualified to form a proper estimate of merit, and who was not less discerning than laudable of conferring undeserved praise, is not less flattering than

† Platina has been improperly stiled a semimetal, as its impurities are removed, it possesses the distinguishing malleability and fixity.

abundance in the Spanish West Indies, the method of fusing it, and the difficulty of effecting the process even by saline additions. From its being specifically heavier than other metals, and from its ready combination with them, arose the practice among the Spaniards of adulterating gold with it; in consequence of which the mines were closed, and the metal became much scarcer. The inference which Dr. Brownrigg draws from his experiments and researches is, that platina has a great affinity to gold in its qualities of fixedness and solidity, to which in other respects it is nearly allied. He concludes with intimating that, similar to many metallic substances, it may probably be possessed of several wonderful properties, and may on some occasions be productive of very important advantages to mankind. Mr. Wood had, with great accuracy and sagacity, previously subjected this metal to various experiments, which Dr. Brownrigg purposed to repeat, intending at the same time to make further experiments upon it with sulphureous and other cements, as also with mercury, and many corrosive menstrua. In performing these experiments, he remarked that platina does not wholly resist the action of lead in cupellation, as he had before supposed.

The extraordinary nature of this newly-discovered metal has long excited the curiosity and attention of philosophers; but the prohibition of its sale has hitherto prevented its application to practical uses. It is, however, to be hoped that regard to their own interests, if not to the improvement of the arts and sciences, will no longer suffer the Spaniards to continue the interdiction of this valuable article. Their apprehensions lest it should be employed in the adulteration of gold are now groundless, since the fraud may, without difficulty, be detected by the methods which chemists have proposed. When we consider that in this metal the fixity of gold is joined to the hardness of iron, that it cannot be acted upon by acids, that it is not injured by water or air, and that it is incapable of being corroded and impaired by rust, we are led to indulge the sanguine expectation that, if its commerce was subject to no restrictions, benefits would result to society of which we can at present form only an imperfect conception. Mankind will then pay a just tribute of gratitude and veneration to the memory of that person who gave to the world the first intelligence of its existence and properties. Long were the miners of Peru acquainted with this metal before its introduction into Europe; and if Dr. Brownrigg had not brought it forward to public notice, the knowledge of it might, even in the present age, have been confined to that illiterate class of men.

In some explanatory notes to A descriptive Poem addressed to two Ladies at their Return from viewing the Mines near Whitehaven,* published in 1755 by John Dalton, D.D. is contained a

* This poem, and its explanatory notes, are inserted in Peare's Oxford Collection of Poems.

short account of those mines, which proceeded from the pen of Dr. Brownrigg. These notes are not intended to form a history of collieries, or a philosophical treatise upon their peculiar exhalations; but merely to illustrate and confirm the poet's description of the operations and appearances in the mines. An accurate relation is given of the various expedients which attentive observation and melancholy experience have at different periods suggested for the purpose of preventing the explosions of the fire-damp, and the fatal effects of the choak-damp. The scenes exhibited in those subterraneous regions, which fill the mind with awe, surprise, and terror, are delineated with equal elegance and perspicuity. The circumstances which are mentioned relative to the strata of coal, the depth of the mines, the uses of the steam-engine, the original establishment of the collieries, and their influence on the prosperity of Whitehaven, are curious in themselves, and must to many persons, from their local residence, be particularly interesting.

These notes are deserving of praise, as being a valuable specimen of topography, and as containing a faithful description of mines, the most extraordinary of any hitherto discovered, and concerning which no authentic information had appeared before the public. An indubitable proof of their merit is, that those writers who have noticed the coal-works at Whitehaven are, in a great measure, indebted for their accounts of them to Dr. Brownrigg.

In the 49th volume of the Philosophical Transactions, for the year 1756, is inserted a paper written by Dr. Brownrigg, which is intitled, Thoughts on the Rev. Dr. Hales's new Method of Distillation by the united Force of Air and Fire. The following circumstance gave occasion to this publication. Dr. Hales, who has enriched philosophy by many ingenious and valuable discoveries, had proposed a new method of distillation, by which, from the combined power of air and heat, a greater quantity of steam was raised than by any former process. The perfect separation of fresh water, in a large proportion, from sea water, was the immediate advantage which he expected from this discovery; and the benefit of navigators was his particular object. Desirous, however, of rendering its uses more extensive and important, he requested Dr. Brownrigg to consider its application to the improvement of those mechanical operations which depend on the action of steam. Dr. Brownrigg, in compliance with his friend's solicitation, carefully and attentively examined whether this discovery was adapted to increase the power and facilitate the motion of the steam-engine. Convinced that Dr. Hales's method of exciting so violent an agitation of the water was inapplicable to that machine, and prompted by the interesting nature of the subject to extend his inquiries, he considered what other expedients, unaccompanied with similar inconveniences, were calculated to produce the same effects. The improvements which he suggests in the construction and operations of the steam-engine were the result of this investigation. *Altho' the Doctor, with that modesty which is the inseparable attend*

and best criterion, of intrinsic merit, expresses a doubt of their success in practice, and regards them merely as conjectures, not sanctioned and established by experience; yet, when submitted to the inspection of Mr. Carlisle Spedding, at that time superintendent of the coal-mines at Whitehaven, they received the approbation of that eminent engineer. The quantity of steam was increased, in Dr. Hales's process, by a current of air introduced into the still; which, either by the rapidity of its motion, or by its attraction of the watery particles, accelerated the distillation. From a just consideration of the nature and principle of the steam-engine, it must be obvious that such a method of promoting evaporation would impede, rather than assist, the operations of the machine. When the regulator, or valve, which stops the communication between the boiler and cylinder, is opened, the steam rushes with impetuosity from the boiler into the cylinder, and overcoming by its superior force the pressure of the atmosphere, elevates the piston. As one extremity of the lever, or beam, is attached to the piston, and the pump-rod is fixed to the other extremity, whilst the former is thus raised, the latter will be proportionably depressed. The steam being next condensed by a jet of cold water, a vacuum is made in the cylinder; the external air, experiencing little or no resistance, presses down the piston; the pump rod, in consequence, is elevated, and the water ascends from the same cause as in the common pump. From this brief account, it appears that the ascent of the water depends on a vacuum being produced in the cylinder. Supposing, therefore, that a great increase of steam was obtained by forcing into the boiler a stream of air, although the piston would be raised, and the pump rod descend, yet a portion of air entering into the cylinder, and remaining after the condensation of the steam, would, by its elasticity, counteract the weight of the incumbent atmosphere, and prevent the depression of the piston. The engine, in consequence, would be deprived of that regularity and uniformity of motion which arise from the alternate action of the steam and the atmosphere.

Sensible of this disadvantage, Dr. Brownrigg directed his thoughts to the discovery of some other method, calculated to increase either the quantity or the elasticity of the steam. The improvements which he proposes consist, first, in assisting evaporation by a mechanical agitation of the water in the boiler; and, secondly, in rarefying the steam by heat. For producing the former effect, to a wheel placed in the boiler motion should be communicated by the exertions of a labourer, by the force of the water which the engine raises, or by a crank suspended from the beam. But the introduction of elastic steam into the boiler is more particularly recommended, as being better adapted to promote evaporation. For this purpose strongly elastic steam, contained in an eolipile, or *small boiler*, is to be conveyed, by means of a tube, into the large boiler, at the bottom of which the tube must be divided into several

smaller tubes, perforated with holes. The steam being thus confined within a narrow compass, and being prevented from escaping through any aperture, except the holes, will pass with considerable violence into the large boiler; and from the commotion thus excited in the water, the evaporation will be much accelerated.

From certain facts and experiments, Dr. Brownrigg concludes that steam is capable of a greater degree of expansive force, by means of heat, than it usually possesses, when applied in the steam-engine. He therefore suggests two methods for increasing the heat of the steam; first, by carrying through the fire of an air furnace the pipe which forms a communication between the boiler and the cylinder; or, secondly, by fixing it in the flue of the common furnace.

It is necessary to observe, that neither the heat of the same quantity of steam which is commonly employed in steam-engines, nor the quantity with the same degree of heat, can be increased in the manner proposed; since if the steam was above one pound per square inch stronger than the pressure of the atmosphere,* the danger of its bursting the boiler would be very great. If, however, the steam raised in a smaller vessel will, in consequence of its quantity or its heat being increased by these contrivances, possess the same degree of force as the steam now used, the expenses which arise from the size of the boiler, the consumption of fuel, and the price of labour, would be much contracted.

Of this publication it may with justice be observed that it affords an additional evidence of Dr. Brownrigg's inventive talents and comprehensive mind. And as it displays his knowledge of subjects † not immediately connected with professional studies, so it proves the subserviency of his inquiries to the real interests of society. The gratification of curiosity, the desire of popular applause, or mere intellectual pleasure, never prompted him to degrade the dignity of reason by idle and unprofitable speculations. It was his opinion that the noblest powers of the human mind were best applied when directed to the uses of mankind, and that the merit of literary labours could only be appreciated and determined by their reference to this end.

In the year 1771 the appearance of the plague in some distant

* To prevent such an accident, there is a pipe fixed in the boiler, with a valve loaded with lead, equal to about one pound per square inch. When the steam is so powerful as to lift about 16 lb. upon every square inch, this valve rises, and suffers the steam to pass into the open air until its force is less than 16 lb. per square inch; then the valve drops down, and permits no more steam to escape.

† This remark is not intended to convey the most distant insinuation that mechanics can have no influence on the improvement of medicine. A previous acquaintance with this useful part of natural philosophy, hitherto too much neglected by medical practitioners, is essentially requisite to a right knowledge of myology, and to the success of many operations, which it is the province of the surgeon to perform, and which the physician has frequent occasion to superintend. It must, however, be obvious that, amidst the multiplicity of important objects which have a claim to serious consideration, an attention to this particular branch of mechanics might, without impropriety, be omitted.

parts of Europe had produced a general apprehension lest it should, as was formerly experienced, very widely extend its fatal ravages. In consequence, his Majesty, whose reign has been distinguished by an anxious and unremitting attention to the welfare and happiness of his subjects, had displayed his prudence and affectionate regard in taking suitable precautions to prevent its introduction into this country; and had expressed, in a speech from the throne, his firm confidence in the immediate concurrence of his Parliament at any future period, when more imminent danger should dictate the necessity of making additional provisions for the security of these kingdoms. In answer to this gracious communication, the two Houses of Parliament respectively declared their perfect coincidence of opinion with regard to the propriety of adopting preventive measures, and their disposition to comply with his Majesty's benevolent wishes.

The expediency of amending the laws now established as a barrier against this destructive malady is thus intimated by his Majesty and the whole British Legislature. Upon which occasion Dr. Brownrigg, observing their defects, and actuated by principles of duty and humanity, was prompted to offer to the public a treatise, intitled, *Considerations on the Means of preventing the Communication of pestilential Contagion, and of eradicating it in infected Places.* The danger at that time threatening the nation from the near approach of so dreadful a calamity, and the desire to mitigate in future the virulence, and suppress the baneful influence of contagious fevers, long prevalent in this country, were the laudable motives which excited his attention to this interesting inquiry. He therefore collected many well-attested facts concerning the origin, progress, and nature, of pestilential contagion; and the methods by which it is conveyed from place to place, and from one person to another.

The practicability of preventing its propagation in highly infected situations was the next object of his consideration. On a review of the laws relating to this disease, he shows the instances in which they are defective, or are capable of improvement, and what is the most easy and certain manner of carrying them into execution. He then enumerates those measures the efficacy of which, in arresting the progress of pestilential contagion, has been confirmed by experience. The laws of quarantine, as first introduced by the Venetians, and improved by subsequent alterations, are strongly recommended, from their obvious tendency to preclude its importation; and some useful additions are suggested respecting the restriction of clandestine trade, and the erection of lazarettos. From the importance of the subject, a particular account is given of bills, or manifests of health, the plan of conducting them as adopted by different nations, the intimations which they convey with regard to the degree of infection in the country whence they are transmitted, and the means of obviating those impositions which are frequently practised. In consequence of the establishment of these bills, and

of a strict attention to the information contained in them, this kingdom has been long preserved from the ravages of the plague, which formerly almost depopulated its metropolis, and has often raged with violence upon the continent.

Of these salutary provisions, the most essential consist, first, in a constant communication of intelligence relative to the state of salubrity among foreign nations; the names of those vessels which have omitted, by neglect or evasion, the necessary precautions; and the number of seamen who have been lately afflicted with the distemper: secondly, in destroying the bed-clothes, wearing apparel, and every article qualified to imbibe or retain the infection: thirdly, in thoroughly washing and ventilating the ship: fourthly, in receiving no merchandize until perfectly purified: lastly, in the exact obedience of the commander of the vessel to his directions, and a punctual discharge of every requisite obligation. For his instruction, therefore, a brief abstract should be made of the laws and regulations now in force which relate to the prevention of the disease, with rules of conduct respecting it, and an accurate description of its characteristic symptoms.

Where the danger of its rapid extension is much to be apprehended, it would be expedient to interrupt every source of connexion, to restrain the commerce, to prohibit the importation of goods capable of conveying the infection, and even to preclude all intercourse with the objects of it, and with the places which it infests, by inclosing them with lines, and by appointing proper guards for their defence. This last method has been adopted in Hanover, Marseilles, Messina, Reggio, Istria, and Dalmatia, with repeated success; and, under similar circumstances, by the Hottentots, in preventing the progress of the small-pox. The Doctor next expatiates on the advantage of giving speedy information of the first appearance of the disease to proper officers, constituting a board of health, in order that every exertion may be used for its eradication. The support and cure of the sick at the public expense are recommended, both from political considerations, and as the dictate of humanity. To these respective heads a very judicious and circumstantial attention is paid, the various customs of other nations being explained, and positive evidence given of their efficacy.

The conclusions drawn from the facts related are highly important; and demonstrate that the contagion is received by immediate contact, or by morbid effluvia, which cannot be carried through the medium of the air to any great distance; and that the inhabitants of adjacent houses, if unconnected with infected situations, will be unsusceptible of it. Of this consolatory assurance several well-attested proofs are introduced, which evince this to be the best prophylactic measure; one that is not only most agreeable to our feelings and desires, but to which we are prompted by the irresistible impulse of that first law of nature—self preservation. The former practice of secluding the sick is shown to be cruel.

insecure. The safety of the public cannot be endangered by the allowance of proper assistance to the unfortunate victims of the distemper, or by the attendance of those who have recovered upon such as may afterwards suffer it, if the precaution be used obliging them to occupy separate and detached houses. This mode of treatment, in its application to every class of the community, is justified by its propriety and humanity; whilst the hazard and occasional inconvenience arising from its omission are powerful arguments in its favour.

Should this nation be ever again afflicted with so dreadful a visitation, these provisions must be strictly executed, carefully precluding all connexion with the house, street, or lane, in which the contagion prevails; and we may rest assured that their influence will be efficacious and extensive. With regard to the eradication of this exotic contagion, which appears to have been imported by war or commerce, the means already directed will be sufficient for the purpose; and it is earnestly recommended to admit no intercourse with the infected persons, goods, or habitations, until they are entirely purified.

Of the numerous notes, and references to facts and authorities, which confirm the doctrines advanced, it may be briefly remarked that, collected with accuracy and judgment, they contribute to elucidate the important subject, and prove the utility of the preventive plan deduced from them. Not only to the plague, but to every nervous, putrid, or bilious fever, these obstructions are strictly applicable. Whilst the observations of practical writers are, with this view, copiously introduced, the Doctor very properly avails himself of that experience which he had derived from a long and diligent performance of professional duties. He has hence, as intimately connected with the immediate object of this publication, given a particular account of the rise and progress of an epidemic, corresponding to the jail fever, which prevailed at Whitehaven in 1757 and 1758. This contagion, assimilating to its own nature that of all other acute diseases, and associating their symptoms, appeared under a different form, and with increased virulence. Not only the adjacent, but very distant situations, have long deplored its fatality; and since that period this country has never been perfectly free from its destructive influence.*

* In the summer of 1773 this malignant fever returned with unusual violence. Its first appearance was early in the preceding winter; and in this stage it was accompanied by some degree of phlogistic diathesis. Such, however, was only a temporary and contingent circumstance, which the influence of the season, or exposure to cold, produced in particular constitutions. The disease then proved neither so contagious nor so fatal as in its subsequent progress. Its duration was generally from 7 to 14 or 20 days, and always shorter in proportion as there was a greater degree of inflammatory combination. As the spring advanced, casting off the mask of inflammation, it assumed a more purely nervous aspect, rarely united with any septic tendency. During the summer, which was distinguished by intensity of heat, and dryness of weather, the virulence of its symptoms was powerfully increased. When tracing the disease from its origin, in its progress, a loss was perceived of 1 in 20, then 1 in 10 and 6 patients; whereas now it was

As the apprehension of danger at the time above-mentioned was happily soon removed, this treatise and its prophylactic advice did not receive from the Legislature that attention which they will probably obtain on some future emergency, when it may be deemed eligible to revise the laws now in existence, in order to provide a more effectual security against the introduction and communication of pestilential contagion.

In the year 1772, Dr. Brownrigg, in the presence of Dr. Franklin and Sir John Pringle, who were then upon a visit at his house, performed an experiment of a very curious nature upon Derwent Lake, near Keswick. On pouring a small quantity of oil into the lake, during a great commotion of the water, the surface in a short time became perfectly smooth. This extraordinary effect having been originally noticed by Dr. Franklin, was suggested by him to Dr. Brownrigg. Soon after his departure from Ormathwaite, Dr. Franklin transmitted to Dr. Brownrigg a letter, dated London, Nov. 7, 1773, in which he gave a full and circumstantial relation, not only of every experiment which he had made at different periods for ascertaining this remarkable property of oil, but also of the various incidents which had led to the discovery. An extract of this letter, and also of two letters on the same subject, one from Dr. Brownrigg to Dr. Franklin, dated Ormathwaite, Jan. 27, 1773; the other from the Rev. Mr. Farish, of Carlisle, to Dr. Brownrigg, was inserted in the 64th volume of the Philosophical Transactions, for the year 1774.* Although the influence of oil in allaying the agitation of water is expressly mentioned by Aristotle, Plutarch, and Pliny; † and although a knowledge of it, derived from tradition, had contributed much to the advantage of divers and fishermen in their respective occupations, yet it had not hitherto attracted the attention of any experimental philosopher.

Accidentally observing in 1757 a partial stillness of the waves

found that the deaths and recoveries were nearly equal, and unhappily on some occasions that the former exceeded the latter. At this period, and during the remainder of its continuance, miliary in many, and even petechial eruptions in some cases, appeared generally about the 7th or 11th day. With regard to the duration of this disease, it did not finally recede, nor were its symptoms sensibly mitigated, before the following spring.

* It is entitled, *On the stilling of Waves by Means of Oil.*

† This circumstance suggests a useful lesson to modern philosophers. It teaches us that the opinions of the ancients on philosophical subjects are entitled to some degree of deference and respect, and that a general ridicule and contempt of what successive ages have preserved with religious care are the characteristics rather of sciolism and pedantry than of solid learning. To select one instance from the many pretended discoveries of the moderns: the effects of boiling upon water, which Dr. Black ascertained, in rendering its congelation more easy and rapid than before it has undergone that operation, were known to Aristotle, Hippocrates, Aethnæus, Galen, and Pliny. The pride and incredulity of the present generation should also be repressed, by the confirmation which the accounts of Herodotus respecting many curious phenomena in the interior parts of Africa, and in other countries, have received from the representations of subsequent travellers. Instead of being the fictions of romance, or the suppositions of a visionary speculatist, they are now proved *neither to deviate from truth, nor to be heightened by exaggeration.*

near some ships, Dr. Franklin was struck with the singularity of the circumstance; and, upon inquiry, was informed that it was occasioned by water which had been thrown into the sea after being applied to culinary purposes. Dissatisfied with this solution of the difficulty, but recollecting at the same time the remark of Pliny, his mind fluctuated between the apparent inadequacy of the cause assigned, and the credibility of what had been asserted by that sagacious writer. He resolved, therefore, at some convenient opportunity, to determine by careful experiments whether oil was qualified to moderate the violence of agitated water. By the general success of these experiments, which are related in his letter to Dr. Brownrigg, this wonderful property of oil is now firmly established. In the preservation of ships during tempestuous weather, and in facilitating a landing where there is a dangerous surf, this method of calming the sea will probably, as has already been proved by some instances, be found particularly useful.

As a chemical philosopher, Dr. Brownrigg has not confined his attention to the different gases which arise from the substances, or impregnate the waters, contained in the earth, but has also endeavoured to discover its numerous saline productions. In a letter to Sir John Pringle, President of the Royal Society, inserted in the 64th volume of the Philosophical Transactions, for 1774, he describes 20 specimens of native salts, which were found in the coal-mines near Whitehaven. They were inspected at a meeting of the Royal Society, June 23, 1774, and were afterwards deposited in the British Museum. To this subject he directed his thoughts with a view to account for the generation of such bodies, and to detect their properties and component parts.

1. *Sal Catharticus Amarus*. — Having noticed its remarkable abundance in sea water, and in several mineral springs and lakes, he justly ascribes their peculiar qualities to this ingredient. It is found adhering, in immense quantities, to subterraneous stones and other substances; and hence arises a satisfactory explanation of the mode by which fountains, and the ocean, receive continual and plentiful supplies of it. In the Howgill colliery it is observed to germinate in long, bright, and polished fibres, from grey free-stone. The free-stone discovered in the neighbourhood of Whitehaven, and in all coal countries, is not possessed of cohesion and durability when applied to the purposes of building; which circumstance is to be imputed to the separation of this salt, or of vitriol when in contact with the external air.

2. Another species of bitter salt, similar to the former, which had been taken out of an old coal-work. By a gradual germination from grey free-stone it had at length been formed into a compact mass. Alum, green vitriol, and several other salts, from the specimens presented, had been produced in the same manner.

3. Small, transparent, firm, but irregular pieces of the same salt, very abundant in the Howgill and Whingill collieries. Specimens

of bitter salt in this form were transmitted by Dr. Brownrigg to the celebrated naturalist Sir Hans Sloane, 30 years prior to the date of this letter.

4. The same as No. 3, in a crystallized state, and purified from all extraneous matters. This salt is in a great measure the same as the bittern, the Scarborough salt and the ingredient, which gives to saline purgative waters their essential properties. It resembles also, in its form and medicinal uses, the common Epsom salt. The figure of the crystal is that of a quadrilateral prism terminating in a quadrilateral pyramid. These crystals are diaphanous, and of a beautiful colour. If the action of the air is not entirely excluded, they long retain their natural appearance. This is the case with all the saline incrustations which are produced upon any calcareous or mineral substance.

5, 6, 7. Depurated Epsom salt, in large and regular crystals. The process for obtaining them is accurately described.

8. Sal catharticus amarus, prepared from the bittern of the salterns near Whitehaven. The purity and cheapness of this medicine recommend it as a useful substitute for the common Epsom salt.

9, 10. A saline substance procured from the same bittern, distinguished by the rhomboidal shape of its crystals, and by its unusual bitterness.

11. Scarborough salt, similar to Nos. 7 and 8.

12. Pieces of green vitriol, collected in great abundance from crevices in the pillars of a long-deserted coal-work at Howgill.

13. A very singular specimen of the same. These last two germinating from metallic ores, combine their filaments into compact masses; and hence appears the cause of the curious texture of such saline bodies.

14. Another specimen of the same, exhibiting a clearer proof of this state, and of the natural operations producing it.

15. Green vitriol shooting from pyrites of iron, found near coal, in thin and interrupted strata.

16. Several specimens of the same mineral substance, where the vitriol appears in the interstices of the pyrites; which, from the gradual accretion and separation of the saline matter, is reduced into a powder. This state of decomposition, and consequent decay, in sulphureous and metallic ores, arises from the united power of air and moisture.

17. Native alum, of that species which the ancients called *alumen plumosum*. Fibrous efflorescences of it were found on the surface of some bituminous stones in the collieries at Whitehaven.

18. Purer alum.

19. An aluminous earth, discovered in large quantities near the former salt; very similar, from its astrin-
lities, to burned alum.

20. A species of argillaceous schistu-
smooth and bright surface, which abound
ith a
l is

called generally by miners shale, and by those of this country sill. Alum sometimes shoots from it, and it undergoes little change from the action of fire.

Such were the laudable and beneficial pursuits of Dr. Brownrigg; and in taking a retrospective view of them, we are impressed with equal admiration of the vigour of his genius, and the versatility of his talents. The most successful efforts of the most active mind have seldom terminated in more important discoveries. Dr. Brownrigg was the first who proved that the existence either of the choak, or of the fire-damp in mineral waters, is the cause of their singular qualities; that they may be imitated, in consequence of the solubility of these damps in water; that the presence of fixed air occasions the suspension of iron and calcareous earths in the acidulæ, and that it is entitled to a place among the other acids. To him we are indebted for our knowledge of the valuable metal platina, for various improvements in the preparation of common salt, and in the construction of the steam-engine; for several judicious directions with regard to the prevention of pestilential disease; and some curious information respecting the production and appearance of native salts; the mode of analyzing the Pouhon water; and the precise quantity of fixed air which it contains. By accurate and repeated experiments, he attempted to disclose the latent operations of nature; and the present well-established doctrines relative to carbonic acid gas and hydrogen gas may in a great measure be imputed to his discoveries, which constituted the basis whereon the permanent system of chemical philosophy is now erected. His attainments in every branch of science were acknowledged not only by the literati of this kingdom, but by the most eminent professors on the continent, with many of whom he was either personally intimate, or supported a regular correspondence.

The style which he has adopted for transmitting to the world his opinions upon any philosophical or medical subject is remarkably distinguished for its energy and perspicuity, and is equally remote from affectation, vulgarity, and bombast. His ideas are conveyed in the clearest and most intelligible terms; and the simple narrative of facts is accompanied with that originality of remark, and dignity of expression, which both illustrate and adorn their useful application. In imitation of the example, and in conformity with the advice of Sir Isaac Newton, he made experiments the foundation of all his inquiries. Instead of forming in his imagination some plausible theory, and accommodating to it the phenomena of nature, as had been the practice of several illustrious philosophers, he endeavoured, by an attentive observation of the effect, to arrive at a knowledge of the cause. Reasoning *à priori* is, indeed, little adapted to the limited faculties of man; assuming the delusive appearance of truth, it leads us into an inextricable labyrinth of error.

The celebrity which Dr. Brownrigg deservedly obtained, in the exercise of his profession during a period of 30 years, might have

been predicted by the favourable circumstances connected with his primary attachment to it. From a careful perusal of the Greek and Roman classics, he was perfectly acquainted with their various beauties, which few have the judgment to perceive, or the taste to relish; and so great was his proficiency in the Latin language, that he wrote it with facility, purity, and elegance. Prompted by the impulse of genius, and the united motives of utility and pleasure, to direct his attention to the mathematics, their most abstruse branches soon became familiar to his comprehensive mind. Conversant, moreover, with many of the modern languages, he was well qualified to prosecute the general literary and philosophical studies which are requisite preliminaries to those of the science of medicine. As an experienced and skilful physician, Dr. Brownrigg attained the highest estimation. Zealous were his exertions to suppress and eradicate contagion, whilst he displayed an equal degree of discernment and assiduity in alleviating the pains of chronic infirmities and distempers. Of his medical consequence, the surest proof may be deduced from the frequent application which was made to him by his opulent friends in all cases of difficulty and danger, long after he had relinquished actual practice, with a view to enjoy the *otium cum dignitate*. His removal to London was repeatedly solicited by those who were capable of estimating his professional abilities, and whose influence in the metropolis, and respectability of station, would have rendered their patronage the certain road to immediate honour and opulence. A predilection for his native county prevented him, whilst he resided at Whitehaven, from accepting their flattering invitations; and after his retirement to Ormathwaite, a fondness for rural scenery confirmed him in his resolution.

In this retirement, among other chemical studies, mineralogy was by no means neglected. His cabinet contained several rare metallic and fossil substances; and he was well acquainted with all the subterraneous productions of Cumberland, which in number, value, and curiosity, are not inferior to those of any other county. To the minerals found in the neighbourhood of Keswick he paid particular regard. Having judiciously selected, he carefully analyzed, the ores of black jack and black lead, extracted from the mines at Borrowdale, in order to discover their original properties and adventitious qualities; and the public was much disappointed in not receiving the result of his accurate inquiries.

Many of his leisure hours were occupied in agricultural improvements, which contributed not only to his private advantage in rendering his own estates more productive, but also to that of the inhabitants of Keswick and its vicinity; as in consequence of the methods which he suggested of draining and cultivating lands, the fertility of the soil has been considerably increased.

In this retirement also he indulged that passion for polite literature which had never been entirely sacrificed to more interesting pursuits. Much of his time was devoted to the perusal of the

ancient and modern poets, which had often been to him a source of relaxation and amusement, when engaged in severer studies. By an extemporary application of their descriptions, he was wont to express the ideas which rushed upon his mind when contemplating the scenery of Keswick, where nature exhibits in a collective view the beauties of Italy and the horrors of Switzerland; but influenced by religious motives, and admiring sublimity of conception, he read with serious care the sacred poets, whose compositions are far superior in unaffected grandeur of style, in genuine pathos, and in elevation of sentiment, to the most celebrated productions of unassisted reason.

From this general statement, it may be properly inferred that Dr. Brownrigg was possessed of every qualification necessary to form a chemical philosopher, a dogmatic physician, and an elegant scolar. By his conduct in a civil capacity, which required different talents, he acquired additional honour. Long in the commission of the peace, an acting magistrate for the county of Cumberland, he discharged the duties of that important station with not less credit to himself than advantage to the community.

To this, the public, may be briefly annexed the private character of the man justly estimated not less good than great.* That modesty which ever accompanied his inquiries into the secret works of nature, and which was the result of deep investigation and long research, disposed him to doubt the sufficiency of human reason, and to admit the consequent expediency of a revelation. Convinced also, by frequent experience in the prosecution of his studies, that even objects which are daily presented to the inspection of our senses are yet surrounded by impenetrable darkness, he was not surprised at the mysterious doctrines of the Christian religion. To refuse assent to them because they relate to things which mortal eye has never seen, and which must evidently exceed the limits of our comprehension, was in his opinion disingenuous, as constituting an exception to our general mode of conduct in the common concerns of life. A firm believer in the truth and reasonableness of christianity, he regulated his actions according to the precepts and the example of its divine author. Impressed with just ideas of the attributes of the Creator, and the dependance of man, his piety was at an equal distance from frigid indifference and presumptuous enthusiasm. By a practice conformable to his faith, it was his endeavour to vindicate his name from that imputation of infidelity and irreligion with which the medical profession has been undeservedly stigmatized.†

* The language of Tully may, with peculiar propriety, be introduced upon the present occasion: "*Gratulor, quod eum, quem necesse erat diligere qualiscunque esset, talem habemus, ut lubenter quoque diligamus.*"

† The injustice of this ignominious aspersion is proved not only by the deductions of reason, but also by the powerful evidence of examples. The tendency of philosophical and medical pursuits to inspire the mind with suitable notions of the Supreme Being, and to restrain the pride of human wisdom, seems to be an effectual antidote to the poison of infidelity. The steady attachment of Hoffman to the christian religion is displayed in various parts of his publications.—That

Actuated by a spirit of general philanthropy, he was the liberal patron of charitable establishments, especially of such as were calculated to fulfil the scheme which had been the frequent subject of his serious deliberation—that of interrupting the progress of malignant fevers. Amiable and polite in his external deportment, he observed a proper medium between the extremes of proud reserve and vain ostentation. An unprejudiced judgment, a humane disposition, and benevolent affections, were in him happily united; and his life,* extended to a long period, was distinguished by the purity and integrity of his morals, the mildness of his temper, the elegance of his manners, and his uniform regard to religious obligations.

Of the merits of this excellent man, thus imperfectly delineated, his intimate friends, and the society which he adorned, will ever retain an affectionate remembrance; whilst this country, impressed with a grateful sense of his services, will assuredly pay to his memory the just tribute of admiration, respect, and esteem.

ARTICLE II.

Application of Fluxions to Lines of the Second Order or Degree.

By Alex. Christison, Esq. Professor of Humanity in the University of Edinburgh.

(To Dr. Thomson.)

MY DEAR SIR,

I SHALL endeavour to show how very easy it is to apply fluxions to lines of the second order deduced from Euclid, I. 47.

In the semicircle, (Plate LXXIV., Fig. 3,) A E D, let E H and F G be perpendicular to the diameter A D, H the centre, A the origin of the perpendicular co-ordinates A C, A B; a = the radius, $y = FG$, $GA = -x$, $HG = x$, $KG = x^2$, $HJ = a^2$; then, by Euclid, I. 47, $a^2 = \overline{HF}^2 = x^2 + y^2$; but $HJ = a^2 = x^2 +$ the gnomon $A I K = 2a - x \times x = 2ax - x^2$; therefore $x^2 + y^2 = x^2 + 2ax - x^2$; consequently $y^2 = 2ax - x^2$, and $y = \pm \sqrt{2ax - x^2}$, and F G an ordinate = the positive root.

the principles and practice of Boerhaave corresponded to that standard which is laid down in the Holy Scriptures, appears from a memorial drawn up by himself. His attention to the duties of public and private devotion was never interrupted by the multiplicity of his professional or literary engagements; and the first hour in the morning was dedicated to prayer, and to meditation upon the sacred writings. The compositions of the celebrated Baron Van Haller, in prose and poetry, on religious topics, are proofs that he was not less eminent for his piety than for his learning. More instances might be adduced; but these are sufficient to show that this accusation is false and groundless.

* Dr. Brounrigg died at Ormathwaite, Jan. 6, 1800, aged 88 years.

Let now the curve $DMNA$ be conceived to cut every ordinate of the circle in the proportion of b to a ; that is, let every ordinate of this curve be the $\frac{b}{a}$ part of the corresponding ordinate of the circle, then b being = HM , $y' = \pm \frac{b}{a} \sqrt{2ax - x^2}$ for the ellipse, and GN an ordinate = the positive quantity.

Let there be now a curve with $x = AQ$ positive, while a and b remain as in the ellipse; and in the curve $APPS$ out of the circle, $y' = \frac{b}{a} \sqrt{2ax + x^2}$, and $PQ =$ the positive quantity, for the hyperbola.

Let there be also a curve AOR with $2a = p$, for one of its factors, and x for the other factor, then $y' = \pm \sqrt{2ax} = \pm \sqrt{px}$, and $OQ =$ the positive root for the parabola.

To every one of an infinite number of ellipses within the circle will correspond an hyperbola out of the circle; to the circle will correspond the equilateral hyperbola AT ; to every one, as AVD , of an infinite number of ellipses circumscribing the circle, will correspond an hyperbola, as AU , out of the equilateral hyperbola; to the circle evidently belongs one parabola only.

From the same equations other important properties may be derived, both by common algebra and by fluxions.

A learner, if he acquired early these four equations, so very easily acquired, would see with pleasure the affinity between Euclid's I. 47, and the equations to the conic sections; and also the affinity among the four equations themselves. The connexion between these and the geometrical equations obtained from the sections of the cone may be afterwards shown to him. When I mentioned, about a year ago, this deduction to my friend Mr. White, of Dumfries, he told me that he had deduced them geometrically from Euclid, II. 14.

If the general equation to a straight line be combined with the general equation to lines of the second degree, as is done by Lacroix in the application of algebra to geometry, the various properties of the conic sections will be obtained.

In an article which you published in May, 1815, fluxions were obtained independently of motion and of vanishing quantities, by the application of algebra to curves, and by bisecting the increment of the absciss according to the method of ancient geometry. I shall now endeavour to obtain the calculus algebraically after defining it by its *essence*. This definition will apply to its *form*, whether numerical, or geometrical, or algebraical.

Any uneducated man has a notion of *rates*. He will say that a particular person is walking at the rate of 3 miles an-hour, that another is running at the rate of 8 miles: he may be told that the rates 3 and 8 are the fluxions; that these two rates 3 and 8 have

one ratio only, as 3 : 8, and that 3 is the antecedent, 8 the consequent of the ratio, expressed fractionally thus, $\frac{3}{8}$.

DEFINITION.

Fluxions may be defined, a method for finding the relation between the rates of change in a quantity and its function : the definition, when it is limited to one variable quantity and its function, may be expressed thus, a method for finding the ratio of the rates of change in a quantity and its function.

PROBLEM.—TO FIND THE FLUXION.

Case I.—To find the Fluxion of x^m , m being any positive integral Number.

It will afterwards appear that $\dot{x} = 1$ may be assumed for the fluxion or rate of change or of variation in x , when x varies uniformly ; x^m may be expressed thus $x \times x \times x \times \&c.$, with x as often employed as their units in m ; and if the first x alone vary, and if \dot{x} its rate of variation be multiplied into the rest, the result will be $1 x^{m-1} \dot{x}$; if the second x alone vary, and if its rate be multiplied into the rest, the result will also be $1 x^{m-1} \dot{x}$; if every x thus vary in succession, the sum of all the results will be $m x^{m-1} \dot{x}$, the fluxion of x^m : consequently the ratio of the fluxion of x to that of x^m is, as $1 \dot{x} : m x^{m-1} \dot{x}$; $1 \dot{x}$ and $m x^{m-1} \dot{x}$ may be represented by a square and an oblong, thus,

$$\dot{x} = 1 \begin{array}{|c|} \hline 1 \dot{x} \\ \hline \end{array} \quad x = 1 \begin{array}{|c|} \hline m x^{m-1} \dot{x} \\ \hline \end{array} ;$$

as the square ; the oblong :: $1 \dot{x} : m x^{m-1} \dot{x}$.

The law of the descent of heavy bodies will illustrate this subject with regard to x and x^2 a function of x . Let x , Fig. 4, represent a variable line, and the line x^2 its square ; and let a body be supposed to descend from x towards A by regulated motion over a pulley, uniformly and perpendicularly to the horizon, through $16\frac{1}{4}$ feet in a second ; let at the same instant a body be dropped from the same height at x^2 : the rate of moving in x at the end of each second is always $16\frac{1}{4}$ feet = $1 p$, p being a portion of space = $16\frac{1}{4}$ feet ; the rate of motion in x^2 is, at the end of one second = $2 p$, for the increment of space gone through in the next second is $CE = 3 p$, of which $DE = 1 p$ is owing to the influence of gravitation ; consequently the body would have come by uniform motion in a second from C to D, though the influence had ceased at C : for the same reason, EF is the end of 2 seconds = $4 p$; at the end of 3 seconds of $x^2 = 6 p$; &c. ; so that the simultaneous rates in at the end of

Seconds.

1, as 1 : 2

2, as 1 : 4

3, as 1 : 6 &c.,

.....

or generally, as 1 : 2 x or, as 1 \dot{x} : 2 $x \dot{x}$, \dot{x} being evidently = 1, as formerly assumed.

x^2 may be represented thus, $x \times x$; if the first x alone vary, the fluxion will be $1 x \dot{x}$; if also the second x alone vary, the fluxion will likewise be $1 x \dot{x}$: it is by adding these fluxions that we obtain $2 x \dot{x}$, as above. This process illustrates and confirms the addition of the partial fluxions $1 x^{m-1} \dot{x} + 1 x^{m-1} \dot{x} + \&c.$, in order to obtain $m x^{m-1} \dot{x}$, the fluxion of x^m .

Case II.—To find the Fluxion of $x^{\frac{m}{n}}$.

$$\text{Put } y = x^{\frac{m}{n}}, \text{ then } y^n = x^m; n y^{n-1} \dot{y} = m x^{m-1} \dot{x}; \dot{y} = \frac{m x^{m-1} \dot{x}}{n y^{n-1}} = \frac{m x^{-1} \dot{x}}{n y^{-1}} = \frac{m}{n} x^{\frac{m}{n}-1} \dot{x}.$$

Case III.—To find the Fluxion of $x^{-\frac{m}{n}}$.

$$\text{Put } y = x^{-\frac{m}{n}} = \frac{1}{x^{\frac{m}{n}}}, \text{ then } 1 = y x^{\frac{m}{n}}; 0 = \dot{y} x^{\frac{m}{n}} + \frac{m}{n} y x^{\frac{m}{n}-1} \dot{x}; \dot{y} = \frac{-\frac{m}{n} y x^{\frac{m}{n}-1} \dot{x}}{x^{\frac{m}{n}}} = -\frac{m}{n} x^{-\frac{m}{n}-1} \dot{x}.$$

The rule, then, for finding the fluxion of any constant power of x is always the same: multiply by the exponent, diminish by unit, and multiply by the fluxion of the root.

If the second fluxion be deduced from the first exactly as the first was deduced from its fluent x^m , we shall obtain $x^m + m x^{m-1} \dot{x} + m \cdot \overline{m-1} x^{m-2} \dot{x}^2 + \&c.$; and if $(x + \dot{x})^m$ be developed, we shall obtain $x^m + \frac{m x^{m-1} \dot{x}}{1} + m \cdot \overline{m-1} x^{m-2} \dot{x}^2 + \&c.$; and

this binomial series can be easily and rigorously demonstrated by the principle of combinations. The only difference, then, between the fluxional and the binomial series is the denominators, which have evidently no dependence whatever on the numerical value of m . If therefore the successive orders of fluxions be deduced from $x^{\frac{m}{n}}$ and $x^{-\frac{m}{n}}$, and if 1; 1 \times 2; 1 \times 2 \times 3 &c., be put under the

2d, 3d, 4th terms of the fluxional series respectively, we shall obtain the corresponding binomial series: this seems to be the easiest demonstration of the binomial theorem for fractional and negative exponents. No one, I think, can justly say that such a deduction of fluxions is difficult, or belongs to the abstruse parts of mathematics.

To draw Tangents to Curve Lines.

Let the ordinate AB, Fig. 5, be conceived to move uniformly, parallel to itself, at right angles along BC; let a point moving uniformly up BA be conceived to draw the straight line BP; in the position E let two points, H and G, be conceived to move up the ordinate, the former with a retarded, the latter with an accelerated motion; and let all the three points be conceived at I to move up the ordinate at the same rate; then it is evident, that if $\dot{x} = IM$ represent the rate of change in x or KF, $\dot{y} = MN$ will represent the rate of change in y or IF; consequently, by similar triangles, as $\dot{y} : \dot{x} :: y : \frac{y\dot{x}}{\dot{y}}$ = the subtangent S or FB.

In the Conical Parabola.

$$p x = y y; x = \frac{y y}{p}; \dot{x} = \frac{2 y \dot{y}}{p}; \frac{\dot{x}}{\dot{y}} = \frac{2 y}{p}; \frac{y \dot{x}}{\dot{y}} = \frac{2 y^2}{p} = 2 x = S.$$

In any Parabola.

$$p^m x^n = y^{m+n}; \frac{\dot{x}}{\dot{y}} = \frac{m + n y^{m+n-1}}{n p^m x^{n-1}}; \frac{y \dot{x}}{\dot{y}} = \frac{m + n y^{m+n}}{n p^m x^{n-1}} = \frac{m + n}{n} x = S \text{ the subtangent.}$$

From this diagram we may correct logical inaccuracies in several eminent authors. IM = FL is the absolute difference of x the absciss, but MN is the conditional difference of y the ordinate, for MN is terminated not by the curves, but by the tangent; when the curve, as GIO, is convex to the axis, NM is less than the difference MR; and when the curve, as HIQ, is concave, NM is greater than the difference MT. Why then should those very eminent mathematicians, Lacroix and Arbogast, say that the differential is a portion of the difference; for the fluxion or differential NM is greater than the difference MT? Why should L'Huilier, a very eminent mathematician, and others, also say that

$$\frac{d \cdot x^n}{d x} = \frac{\dot{y}}{\dot{x}}$$

is not a compound of two quantities $d x = \dot{x}$ and

$d \cdot x^n = \dot{y}$. Is not each a quantity of indefinite magnitude? and have they not, at every point of the curve, a definite ratio, and consequently a definite fractional value?

In Fig. 5, IM is at I the differential or absciss, MN of the ordinate, IN of the curve; the

imperfect equation; for no error is committed in the calculus, at the admission of the differentials, during their continuance, or at their elimination. Why, then, should Lagrange and Carnot say that the calculus gives right results by a compensation of errors? Some calculators may have entertained such mistaken notions. But the errors are in their minds, not in the calculus. Whosoever, indeed, supposes that a second ordinate at an indefinitely small distance from the first is common to the curve and to the tangent commits a mistake in mathematical logic: but the calculus is not in the least guilty of this mistake. This subject will in future be, perhaps, examined more fully and rigorously. It is expected that Carnot will revise his learned and ingenious work, and free it, with his usual magnanimity, from mistake and contradiction. Why should a learned and able writer in the *Edinburgh Review* for September, 1816, p. 89, say, "It is not sufficient to say, as our author has done, that the fluxion of the quantity must be equal to nothing, because, as in every case, the fluxion of a variable quantity, or the root of a function, may be supposed less than any thing that can be assigned, that quantity may be said, in every case whatever, to be equal to nothing." In Fig. 4, for the law of descent, we see that the increments commonly expressed by Δx and Δy , y here being equal to x^2 , can always in our conception be reduced to nothing; not so $\dot{x} = dx$, and $\dot{y} = dy$. In the line x^2 , Fig. 4, if any portion of a second, how small soever, be taken after the end of one second, and also the same portion before the end, an increment and a decrement will be obtained. The increment and the decrement may be conceived to diminish till they vanish at the precise end of one second: but this conception does not change the fluxion or rate at the end of one second; the fluxion is then measured by two portions of $16\frac{1}{4}$ feet each. If we take for the unit of time 1', or one minute = 60 seconds, we must take the square of 60 = 3600, and say, as $1 \times 3600 : 2 \times 3600$; and if 1''' be taken for the unit of time, we must say, as $\frac{1}{3600} : \frac{2}{3600}$; in both instances, as 1 : 2. The numerical expression of the terms of the ratio is the same in the three instances; but the unit of space is different. When a second is the unit of time, the unit of space is $16\frac{1}{4}$ feet; when a minute is the unit of time, the unit of space is 3600 times $16\frac{1}{4}$ feet; when 1''' is the unit of time, the unit of space is the 3600th part of $16\frac{1}{4}$ feet; so that, if there be motion in the lines represented by x and x^2 , the fluxions cannot be = 0, how small soever the unit of time be; otherwise it would simultaneously be possible for the same thing both to be and not to be.

To find the Area of a Plane Curvilinear Surface.

It is evident that the rate of change in the surface, at y , is $y \times 1 = y \dot{x}$; all that is necessary, then, is to recur from y to its fluent.

In the Conical Parabola, Fig. 6.

$$\dot{x} = \frac{2y\dot{y}}{p}; \dot{w} = y\dot{x} = \frac{2yy\dot{y}}{p}; w = \frac{2yy y}{3p} = \frac{2}{3}xy.$$

In any Parabola, in which $p^m x^n = y^{m+n}$.

$$\dot{w} = y\dot{x} = \frac{m+n y^{m+n}}{n p^m x^{n-1}} \dot{y} \therefore w = \frac{m+n}{m+2n} xy.$$

After obtaining the fluxion of x and x^2 , either as in the article in May, 1815; or, as in this article, from Galileo's law, which is not a mechanical but a mathematical origin of fluxions, it is easy to obtain the fluxion of x^3 , by separating, as x^2 into $x \times x$, x^3 into two factors $x^2 \times x$; for the fluxion of $x^2 = 2x\dot{x}$ multiplied by x added to \dot{x} , the fluxion of x , multiplied by $1x^2$ is $3x^2\dot{x}$; and so on for higher powers. This process is easy, direct, convincing; can be made so general as to include the calculus of variations, and demonstrates rapidly the binomial theorem for fractional and negative exponents. It proceeds from rate to development, not from development to rate. In teaching according to the method here exhibited, it is not necessary to demonstrate, previously, that the increment may be taken so small that any term of the difference shall be more than the sum of all the succeeding terms.

No apology, I trust, is requisite for the freedom I have used in pointing out mistakes in the logic, not in the calculations, of very eminent authors: such fundamental mistakes, so numerous and important, discourage a learner, especially if he be a solitary student, at the very commencement of his examining the simple nature of fluxions rendered unnecessarily difficult, and sometimes circuitous. It will be useful if any one point out the mistakes that I may have committed.

I have found in two or three schools, in Edinburgh and the neighbourhood, great expertness in arithmetic, geometry, trigonometry, conics, and even in the elements of fluxions. Several of the pupils were under fourteen, and few above that age. At the public examinations, the propositions were selected, not by the teachers, but by the examiners. In one school some young ladies, about fifteen, were as expert as the young gentlemen in the higher mathematics. The ignorant and thoughtless part of the public will scarcely believe this fact, I suppose; but the examinations were conducted before gentlemen of more mathematical knowledge than I can pretend to. This most interesting fact deserves to be more fully and circumstantially stated. The mathematical studies of the pupils did not seem to have impeded their classical attainments.

Yours faithfully,

ALEX. CHRISTISON.

Edinburgh, Sept. 6, 1817.

P.S. It will be of great
or two of the calculus of v.

give one application

ARTICLE III.

On the North-West Passage ; and the Insular Form of Greenland.
By Col. Beaufoy, F.R.S.

(To Dr. Thomson.)

MY DEAR SIR,

Bushy Heath, Oct. 14, 1817.

THE reign of his present Majesty will ever be famous for the encouragement given to science ; but in no branch has the King's gracious patronage been more conspicuous than in the discoveries made by different circumnavigators, especially by the immortal Cook. Considering the inducement and encouragement held out by our monarch for exploring the northern parts of the globe, and the number of ships annually fitted out from the different ports of the United Kingdom for Davis's Straits, Baffin's Bay, and Spitzbergen ; it may appear very remarkable that no new discoveries are made, or old verified, or any voyage extended to a higher latitude than 81° North. The King's wish of promoting discoveries in this part of the world is evident from Lord Mulgrave's expedition, and more especially from the Acts of Parliament promising a reward of 20,000*l.* to any of his Majesty's subjects who shall sail through any passage between the Atlantic and Pacific Oceans to the northward of latitude 52° N., and also from a reward of 5,000*l.* to any British ship that shall approach within one degree of the North Pole. To what cause, then, can be attributed the indifference and apathy of those commanders of Greenland ships who, having been unsuccessful in the fishery, might be supposed to have it in their power to defray the expense of the outfit by sailing to the west or the north, with the view of claiming one of the above rewards ? It cannot be said with justice that the masters of our Greenlanders are either deficient in skill, or indifferent to discovery ; for among them, as in other professions, men are found of superior talent and of enterprising spirits. The paradox will, however, be solved by referring to the subjoined oath,* which effectually excludes every conscientious person from endeavouring to carry into execution the scientific views of the Legislature in passing what may, without

* The following is a copy of the oath taken by the master, and also by the owner, of Greenland ships ;—" Master of the ship _____ maketh oath that it is really and truly his firm purpose, and determined resolution, that the said ship shall, as soon as license shall be granted, forthwith proceed, so manned, furnished, and accoutred, on a voyage to the Greenland seas, or Davis's Straits, or the seas adjacent, there in the now approaching season to use the utmost endeavours of himself and his ship's company to take whales, or other creatures living in the seas, and on no other design, or view of profit, in his present voyage, and to import the whale fins, oil, and blubber thereof, into the port of _____. Sworn at the Custom-house."

impropriety, be named the Discovery Act. When this last Act was passed, it is probable the former Act for promoting northern discoveries did not occur to the framers. I remember some years past that a learned and scientific Member of the House of Commons was so much struck with the discouraging effect of the oath, that it was his intention to have brought forward a clause enabling the masters of Greenland ships to prosecute discoveries as well as to catch fish; and it was owing to accident that a clause of the above nature was not introduced. This omission, however, it is hoped, may yet be supplied at no distant period, and Greenland voyages, conducted as they are by seamen best qualified for such an undertaking, be made subservient to the exploring of the northern regions.

It may further be observed, navigating among the ice being in itself a science, men regularly brought up to the sailing and working of ships in the Arctic circles, should be selected for such service, in preference to those accustomed to navigate the more temperate parts of the globe. It follows, therefore, that if at any future period it should be the intention of Government to promote northern discoveries, it would be advisable, both for economy and the greater probability of success, to hire one of the Greenland vessels and crew, sending on board as many scientific and philosophical men as are deemed requisite. The following statement was sent me some years past by Captain Brown, an able and expert seaman, regularly brought up in the whale fishery, who was willing to undertake the exploring Baffin's Bay, or endeavouring to approach the North Pole. He mentioned that though in Baffin's Bay he had frequently run to the westward, he had never got sight of land in that direction; which implies the northern part of America may be much contracted. Brown, unfortunately, was killed at one of the Sandwich Islands:—

“ SIR,

“ Jan. 16, 1789.

“ I shall begin fitting out the first of next month for Davis's Straits; and should you wish to explore Baffin's Bay, I shall be glad to have timely notice, that I may prepare a larger stock of provisions, provide presents for the Indians, and several other articles which will be necessary for that voyage. It will be proper for the bounty to be paid by the Treasury, or the Custom-house oath altered; and I think, when you peruse the subjoined account of expenses, you will not think my requisition of 500*l.* per month for two ships extravagant. I only desire it to be paid from the time of leaving the fishery in 72° N. till we return to Cape Farewell; and no payment to be made unless it shall satisfactorily appear the utmost has been done to explore Baffin's Bay, Lancaster Sound, &c. The expense Government would possibly incur would be very trifling; but as underwriters will not insure such voyages, the owners should be indemnified, and the value of the ships ascertained by the surveyor who values the transports, against the enemy,

and other extra risks. I have perused all the northern voyages, and shall perfect myself in lunar observations.

(Signed)

“WILLIAM BROWN.”

Ship Butterworth, 392 Tons, Boats, and 48 Men.*

	Per Month.		
	5l.	Os.	Qd.
1 Master	5	10	0
1 Surgeon	3	10	0
1 Chief Mate	3	10	0
1 Carpenter	3	10	0
1 Carpenter's Mate	2	10	0
1 Second Mate	2	10	0
1 Boatswain	2	10	0
1 Skim-man	2	10	0
1 Cooper	2	10	0
7 Harpooners at 50s. each	17	10	0
1 Cook	2	0	0
7 Boat-steerers at 40s. each	14	0	0
7 Line-coilers at 32s. 6d. each	11	7	6
17 Men at 30s. each	25	10	6
<hr/>			
48 Men's wages	98	7	6
Men's provisions at 30s. each	72	0	0
Wear and tear, 392 tons, at 5l. per ton.	98	0	0
<hr/>			
	268	7	6

Cabin allowances, presents for Indians, extra liquor, and other encouragement for the people, cannot be estimated at less than 31l. 12s. 6d. per month, making a total of 300l.

Brig Lyon one-third less expense.

As experiments are making on the length of the pendulum in the Orkneys, it is highly desirable that scientific men be sent for the same object in one of the Greenland ships to Spitzbergen; and at the conclusion of the fishery they might return in the same vessels.

Every Greenland vessel should be furnished with an artificial horizon; of which the first and best is a shallow cylinder of wood four inches diameter in the clear, and three-tenths and a half deep, into which, by means of an ivory funnel, is poured quicksilver. To prevent the mercury from being ruffled by the wind, two glass planes are placed over it, whose surfaces are parallel, and forming an angle with each other of 90°; and if this be not sufficient protection when the mercury is agitated by wind, or any heavy object

* A vessel of the above tonnage with a rising floor is the best adapted for this service, as it has a sufficient momentum among the loose ice, and is easily managed.

Passing near, a circular piece of glass is floated on the quicksilver. The second (invented, I believe, by the late Mr. Adams, of Edmonton) is a plane concave glass four inches in diameter, and rounded to a long radius. It is fitted into a metallic box, with its concave side downwards. This box, when wanted, is nearly filled with spirits, leaving a bubble; and by means of three screws, this bubble is brought into the centre of the glass. On one side of the box is a small thumb-screw, to be taken out when filling, that the air may escape. This screw should not be made of iron, because it will corrode. If this instrument be well made, and pains taken in the levelling, it may be depended on to two minutes, which gives an error of one minute of altitude. Neither of these artificial horizons can be used when the altitude of the object exceeds 67° .

It would be extremely curious to ascertain the extent of the variation of the compass in Baffin's Bay. Captain Brown found it to be $9^{\circ} 42'$ West in latitude $72^{\circ} 46'$ N. (see the *Annals of Philosophy*, vol. vii. p. 14); and there being an increase from Cape Farewell to this latitude, it is not impossible that in higher latitudes the augmentation may continue, until the needle loses its polarity; which extraordinary declination of the compass (peculiar to this part of the world) is so remarkable, that, were a vessel sent for no other purpose than of making magnetical observations, both the time and money which might be bestowed on the expedition would be advantageously employed for the advancement of science. The variation of the compass in latitude $70^{\circ} 17'$ N. and longitude $163^{\circ} 24'$ W. is $30^{\circ} 28'$ E.; and in latitude $70^{\circ} 58'$ and longitude $54^{\circ} 14'$ W. is 74° W.; whence it appears that in nearly the same parallel of latitude, and in a difference not exceeding $109^{\circ} 10'$, or about 1685 geographical miles of longitude, there is a difference in the variation amounting to $84^{\circ} 42'$. It would also be a desirable discovery to ascertain whether on going to the westward it would be found that the variation gradually decreases to the point of no variation, and afterwards gradually increases; or whether its return be not by a sudden jump from W. to E. Observations on points of this description, accompanied with remarks on the depth, temperature, and saltness of the sea, and with a meteorological journal, would contain much interesting and valuable information, and throw great light on the natural phenomena of these unexplored regions.

The depth of the sea in Baffin's Bay has been determined beyond doubt by Brown to be more than a mile. It is not unusual in April (the time the Greenland vessels arrive in Davis's Straits) for Fahrenheit's thermometer to stand at 10° or 22° below freezing.

Considerable diversity of opinion prevails respecting the form of Greenland, which is conjectured by some to bend to the westward, and, joining the continent of America, to form the vast and supposed gulf of Baffin's Bay; by others, to be one large island; and by a third class, to be a cluster of islands intersected by a variety of channels running from sea to sea, but so blocked up with ice as to render the passage between them impracticable. In a journal

before me it is mentioned that a strong current sets round Cape Farewell to the north-west, and that the water breaks for several miles. It appears probable, therefore, from this circumstance, that Greenland does not consist of a multitude of islands; because in that case the current would have taken its direction between them, instead of flowing round the extremity of the land. The junction of Greenland with North America appears to me to be likewise improbable, from the following reasons: first, that Brown (as already mentioned) never saw the western land: next, that Hearn in his travels arrived at the sea, seals having been seen by him: and, thirdly, that Mackenzie, whose travels lie to the westward of Hearn's course, came to the mouth of a large river, which also emptied itself into the Arctic Ocean: and, lastly, from the great probability that the immense quantity of drift wood found in Baffin's Bay, on the coast of Labrador, and on the north-west coast of America, has been deposited there after being brought down by Mackenzie's River, and driven to the east and west, and afterwards southward, according to the direction of the winds and currents: all which circumstances combine, in my opinion, to furnish a ground of belief that North, as well as South America, is surrounded by the ocean; and that the north-west passage is to be sought about latitude 72° . That Greenland is an island seems also to be highly probable, from the quantity of drift wood found on the coast of Iceland; for it is much more natural to suppose the trunks of trees found in that part of the world are carried off from the northern extremity of America, and driven round the north of Greenland, than that, being floated from the mouths of the Obi, Lena, and other great rivers of Russia, they should pass Nova Zembla round the North Cape to the prodigious distance of 20° west longitude.

Cape Farewell, the southern extremity of Greenland, according to the Requisite Tables, is in latitude $59^{\circ} 38' 00''$ N. and longitude $42^{\circ} 42' 00''$ W. By observations in my possession, it is in latitude $59^{\circ} 42' 00''$ N., and longitude $45^{\circ} 16' 00''$ W.

I remain, my dear Sir, very sincerely yours,

MARK BEAUFOY.

ARTICLE IV.

On the Cells of Bees. By Mr. Barchard.

(To Dr. Thomson.)

DEAR SIR,

In the 55th number of the *Annals of Philosophy* I was much pleased by seeing that a previous paper of mine had drawn the attention of Dr. Barclay, who, notwithstanding the light way in which he

treats what he calls my hypothesis, still finishes his letter in a way that appertains to a man of science: for, although our ideas on the subject differ, why should we descend to personal scurrility, at all times hostile to the advancement of the object in view. I shall in the present paper endeavour to show Dr. B. by some new experiments, as well as by the explanation of my former ones, the result of my reasoning, and the truth of my inference. In the first place, I must beg to put Dr. B. right with regard to what he calls my hypothesis. I have none: if possessed by either, it is by him, as he stated the case in the first instance, and I only replied. I must impute to Dr. B. some want of knowledge of the domestic economy of the bee, by asking why (if the bees are so sparing of their time and labour) one large cell might not suffice instead of so many small ones. That they are so sparing, we see by the shape of the cells, (the shape being that which admits of most space with the least quantity of material, the angle of the rhombuses terminating the bottom), containing, according to Kirby and Spence's Introduction to Entomology, the exact number of degrees that a skilful mathematician would adopt for the purpose of strength and space. Dr. B. candidly acknowledges the comb he broke before the Wernerian Society was dark-coloured, had been exposed to the weather, and to every appearance had contained brood—the certain symptoms of old comb; the consequence of which would be that on breaking or cutting, it certainly to a superficial observer would appear double; that is, each cell exhibiting the appearance of its own party wall (if I may be allowed the expression); the reason of which we shall immediately see, if we consult Huish's second edition, p. 12, in which he expressly names the lining of the cells: "The bees which are bred in the first combs of a hive will be larger than those which are bred in an old stock hive: for this reason, the cells in an old stock hive having had repeatedly young brood in them, are each time diminished in their capacity by a small film which the bee on quitting the cell leaves behind it," &c. Again, p. 129, "The larva continues to grow for five or six days, and then weaves a whitish, silky film, which is found to be firmly attached to the inside of the cell, and is the cause of its appearing of a different colour from that of new or virgin comb."

I shall now proceed to my own experiments on both old and virgin comb. Dr. B. laughs at the idea of putting the comb into hot water. What other menstruum could be employed, so cheap and simple? He says the cells are stuck together with a peculiar animal glue. I wanted something to dissolve it, and therefore put a piece of old comb with a piece of virgin comb into water, and gradually raised it to near the boiling point; the consequence of which was, that the heat just sufficient to dissolve the virgin comb was also sufficient to dissolve the wax composing the original structure of the old comb. Now virgin comb is very nearly pure wax, therefore, by the heat of the water, it dissolves, and floats on the s

face: the old comb being full of the films left by the young ones, the wax melts and floats, but the comb still retains its cellular appearance, which while in the water may be separated into single cells; but these single cells are not the original formation, but animal matter, and formed by the larvæ or young bees; for we may in a hive of observation see the same comb repeatedly filled with honey; that is, for two or more years; but it still retains the property of virgin comb: but directly this comb has had brood, its appearance is changed; and as soon as put into hot water, separates into the filmy cellular appearance. Now what other conclusion can we draw from this, than that the cells are all built alike; but those which have contained brood are lined by the larvæ, and thus mislead by their double appearance.

Another way in which I have succeeded is to cut a piece of old brood comb into this shape $\wedge\wedge\wedge$ by which means both sides of the same cell can easily be got at; when, by careful dissection, several layers of film or lining may be taken off, and the comb brought to the state it was before it had had brood in it. Being one day at Guy's Hospital, I took the opportunity of dissecting some comb before some of the gentlemen that were present, and who expressed themselves perfectly satisfied with the result. Having now stated my method of experimenting, I should be happy to hear or see Dr. B.'s method. At any time that he is in the neighbourhood of London, I should feel much pleasure in personally explaining the business, and

Remain, Sir, yours with respect,

Waddon, Sept. 21, 1817.

R. W. BARCHARD.

P.S. The comb of the hornet is determinately single, being built of wood in a peculiar state of decay, the pieces of which are sufficiently large to be distinctly seen on both sides of the same cell.

ARTICLE V.

Demonstration of a Mathematical Theorem. By Mr. J. Adams.

(To Dr. Thomson.)

SIR,

Stonchouse, Aug. 7, 1817.

SHOULD you consider the following proposition and demonstration to merit a place in your *Annals of Philosophy*, your inserting them therein will oblige,

Sir, your most obedient servant,

JAMES ADAMS.

Proposition.

In the series $A + Bx + Cx^2 + Dx^3 + \&c.$ where the coefficients $A, B, C, D, \&c.$ are supposed constant, and x arbitrary, x may be so taken that the sum of all the terms except the first shall be less than any finite quantity.

Demonstration.

Let ϕ be any finite quantity whatever, Qx^m the greater term in the proposed series, and $Qx^m = \phi$; from whence x may be found, because $m, Q, \phi,$ are supposed to be given. Now change the value of x thus found into x' , so that $Qx'^m < \phi$; to effect which there can be no difficulty. Hence it appears that x may be so taken, that each of the terms $Bx, Cx^2, Dx^3, \&c.$ may be less than ϕ ; that is, less than any finite quantity whatever. Now in the proposed series, for A and x , substitute ϕ and x' ; and we shall then have $\phi + Bx' + Cx'^2 + Dx'^3 + \&c.$

Where $\left\{ \begin{array}{l} \phi > Bx' \\ \phi > Cx'^2 \\ \phi > Dx'^3 \\ \&c. \end{array} \right\}$ continued to n terms.

Therefore $\phi + \phi + \phi + \&c.$ to n terms $= n\phi$ is greater than $Bx' + Cx'^2 + Dx'^3 + \&c. \dots (1)$. But since ϕ may be any finite quantity whatever, let therefore $\phi = \frac{A}{nq}$; n denoting any finite number of terms except the first, and q any whole number.

Then substitute for ϕ in expression (1), and we have $\frac{A}{q}$ greater than $Bx' + Cx'^2 + Dx'^3 + \&c.$ Therefore x may be so taken that the sum of all the terms, except the first, shall be less than any finite quantity.

In the same manner it may be shown that x may be so taken that any term of the series shall be indefinitely greater than the sum of all the other terms which contain higher powers of x .

For $Bx + Cx^2 + Dx^3 + Ex^4 + \&c. = x(B + Cx + Dx^2 + Ex^3 + \&c.)$

But it has been demonstrated that $\frac{B}{q}$ may be greater than $Cx + Dx^2 + Ex^3 + \&c.$ Therefore $Bx > q(Cx^2 + Dx^3 + Ex^4 + \&c.)$; that is, x may be so taken that Bx may be indefinitely greater than the sum of all the other terms of the series which contain higher powers of x .

The principles contained in the preceding demonstration are similar to those in Mr. Cresswell's *Ma* Minima.

If in the equations $\left\{ \begin{array}{l} x' = A - Bx + C \\ z = A + Bx + C \end{array} \right. - \&c. \dots (2)$

x be so taken that the sum of all the terms which follow Bx shall be less than that quantity, however small it may be; let then Bx be considered as indefinitely, or incomparably small; and since the sum or difference of two indefinitely small quantities are likewise indefinitely small, we may conclude that on this supposition the above equations would become $z' = A - 0$, and $z = A + 0$, which state z' will become a maximum, and z a minimum.

Now since Bx is considered greater than the sum of all the succeeding terms, it is evident that if Bx becomes nothing, the said sum will necessarily become less than nothing, to represent which the signs of each of the succeeding terms must be changed. The proposed equations would in this case become

$$\left\{ \begin{array}{l} z' = A - Cx^2 + Dx^3 - Ex^4 + \&c. \\ z = A - (Cx^2 + Dx^3 + Ex^4 + \&c.) \end{array} \right\} \dots\dots\dots (3)$$

If in these last equations x be so taken that Cx^2 shall be greater than the sum of all its succeeding terms, and Cx^2 conceived to become nothing; on this supposition the sum of all the succeeding terms must evidently become less than nothing, and therefore the signs of each of the terms must be changed; equations (3) will now become

$$\left\{ \begin{array}{l} z' = A - Dx^3 + Ex^4 - Fx^5 + \&c. \\ z = A + Dx^3 + Ex^4 + Fx^5 + \&c. \end{array} \right\}$$

which are manifestly similar to equations (2).

In like manner may Dx^3 , Ex^4 , &c. be made to vanish, and the greatest and least values of z' and z exhibited at each change.

ARTICLE VI.

On some Points relating to Vision.

ALTHOUGH the physiology of vision has met with considerable attention from philosophers, it is yet in many respects but imperfectly understood; and whilst it may be pretty satisfactorily explained upon general principles, the use of the individual parts composing the delicate organ by which it is accomplished is still involved in much obscurity. For illustrating some points connected with the healthy and abnormal state of some of these, more especially of the iris, the following experiments and observations are submitted to the inspection of your scientific readers.

A portion of the newly prepared extract of belladonna, for the sake of experiment, was inserted between, and applied to, the eyelids; in consequence, in the space of about 20 minutes, the pupil was so much dilated, that the iris was almost totally invisible. From the time that the pupil attained to three times its natural dimen-

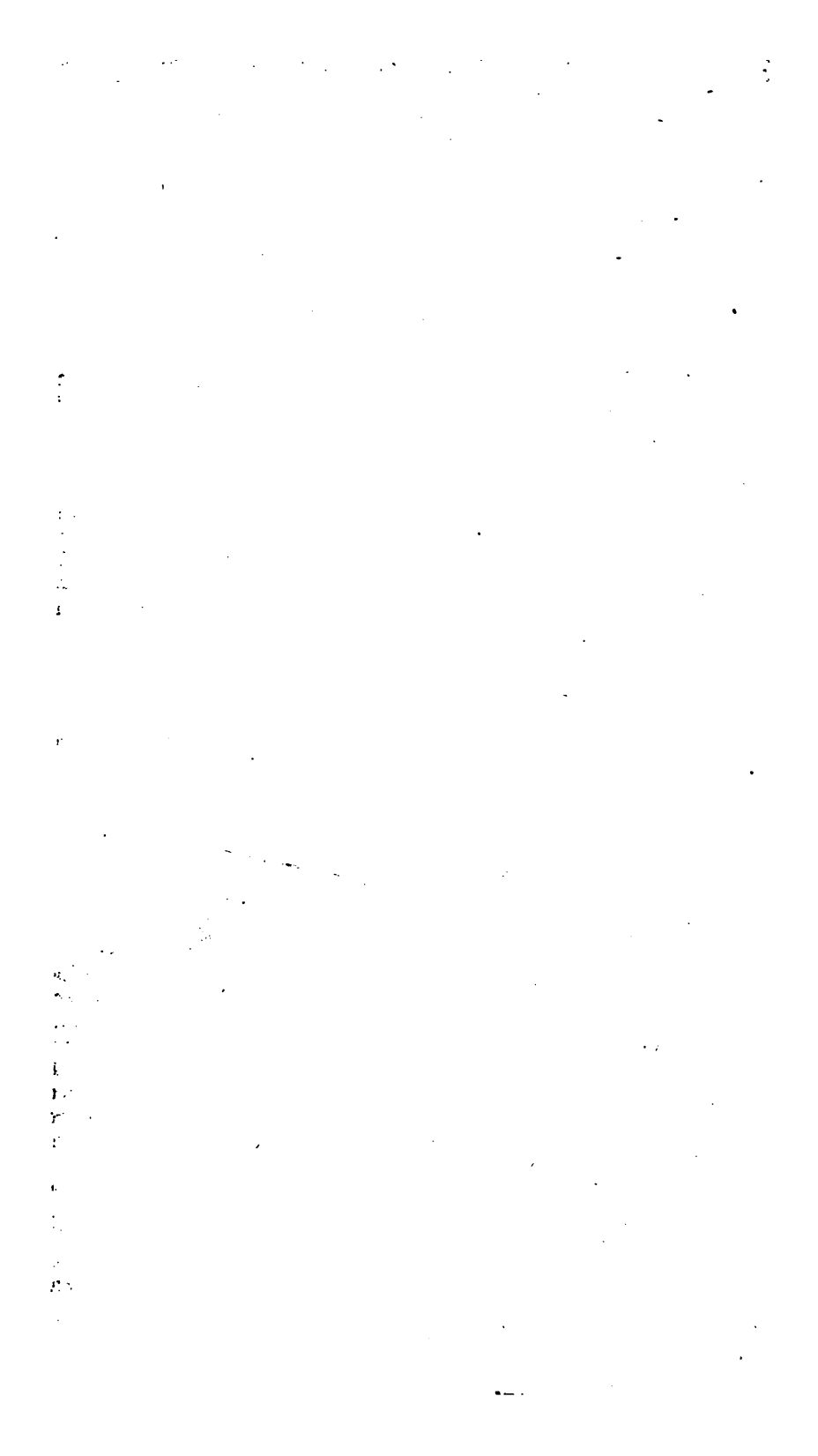

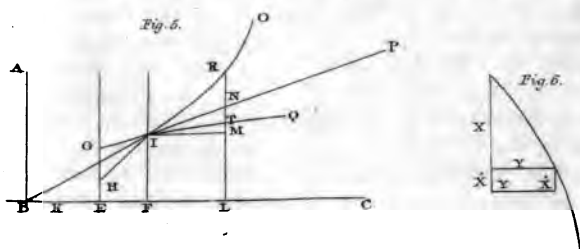
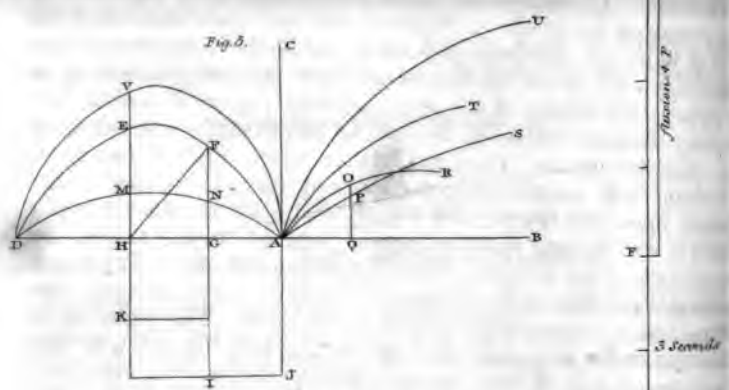
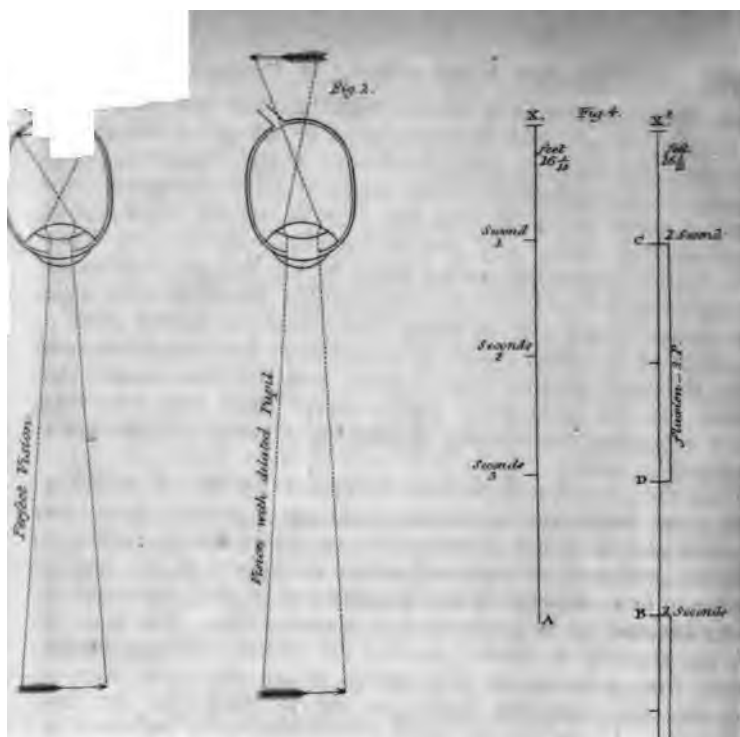

sions, objects presented to this eye with the other closed were seen as through a cloud; and as it proceeded to the point of extreme dilatation, this effect gradually increased, so that minute and near objects, as letter-press, &c. could not be at all distinguished. By means of a double convex lens, the focus of this eye was found to be at twice the distance of that of the sound eye: the iris, however, dilated * upon the sudden admission of light; and although the pupil approached by almost imperceptible degrees for six days to its natural size, yet at the end of that time it was dilated to twice the extent of the other; and, in proportion as the contraction took place, the sight became more distinct, and the focus nearer the natural. In the open air all objects except those near were distinctly seen, but immediately on entering a room all was again enveloped in mist.

From the preceding experiment it appears that the iris certainly holds a very important part in the physiology of vision. It will be seen that as soon as it had contracted to a certain extent, indistinct sight was produced, of the same nature as happens in the eyes of presbyopic or aged people; and the same sort of glass was required by the affected eye as is necessary in advanced life. The cause of this can scarcely be looked for in a diminished convexity of the cornea, from a decrease of the humors, as the effect took place so soon after the cause was applied, as not to allow time for that occurrence. It seems to me much more satisfactorily explained by the increased size of the pupil permitting too great a quantity of the rays of light to be thrown upon the crystalline lens, and these when again refracted by the last-mentioned body, not being thrown so as to impress the image of the object accurately upon the retina, but at some distance behind it, as may be more readily understood by the annexed figures (Plate LXXIV.); where Fig. 1 represents the vision in its natural state, the inverted image being exactly impressed upon the retina; and Fig. 2, that with the dilated pupil, where it will be seen that the rays of light are thrown so near the extremities of the crystalline lens that, when refracted, they do not converge sufficiently to impinge the object correctly upon the retina, but at a considerable distance behind it. This principle of refraction in the crystalline lens may be familiarly illustrated by that of a common convex lens, where, if the rays of light from any object are allowed to occupy the whole circumference of the glass, the object is seen indistinctly through it. It would appear, therefore, that one great use of the iris is for allowing only a certain proportion of the rays of light to be thrown upon the lens, and that, when the pupil is preternaturally dilated, indistinct vision, analogous to what takes place in a diminished convexity of the cornea, is the consequence, from too great a divergence of the rays proceeding from

* It may be proper to remark, in order to prevent misconception, that I have used the term dilatation of the iris to signify that state in which the pupil is contracted, and *vice versa*.

any object: and thus the dilated pupils of myopes, or short-sighted people, would appear to consist in an effort of nature to remove the defect; for if, along with the greater degree of convexity in these cases, the pupil remained of the same dimensions, too few of the rays of light would fall upon the retina; but when the pupil is dilated, it admits a greater quantity, and in all probability prevents the increased degree of short-sightedness which otherwise might have occurred.

One curious anomaly with respect to the iris remains to be noticed, viz. that it should be so long in dilating, after it had been once contracted, a space in this instance of more than 40 days, although the sensibility was not taken away by the narcotic, as was evident from its dilating perceptibly on exposure to light.

London, Nov. 4, 1817.

ROBLEY DUNGLISON.

ARTICLE VII.

Register of the Weather in Plymouth for the last Six Months of 1816. By James Fox, jun. Esq.

(With a Plate, LXXV.)

JULY.

Date.	Wind.	Rain.	Observations.
1816. July 1	WNW	} 0.35	Hail showers during the day; fair at night.
2	WNW		Showers early morn; cloudy and fair afternoon.
3	W	} 0.15	Showers, morn; cloudy afternoon.
4	W		Showers, morn; cloudy and fair afternoon.
5	NW	} 0.65	Cloudy and fair.
6	SE to NW		Cloudy morn; heavy rain, afternoon.
7	S	0.23	Cloudy and fair morn; showers, afternoon.
8	ESE	} 1.25	A gale of wind, and heavy rain.
9	S		High wind and heavy rain, morn; cloudy and fair, afternoon.
10	SW	} 0.16	Cloudy and fair morn; thunder and lightning, afternoon.
11	NW		Cloudy morn; misty afternoon.
12	NW		Misty morn; high wind; cloudy and fair afternoon.
13	WSW	} 0.28	Cloudy and fair.
14	SW		Thick weather.
15	SW	} 0.68	Cloudy and fair day; cloudy at night.
16	NW		Heavy rain, morn; cloudy and fair afternoon.
17	S	0.51	Heavy rain.

ME Plym
(above Sea)
T E
October

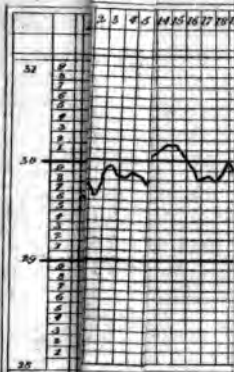

M R.

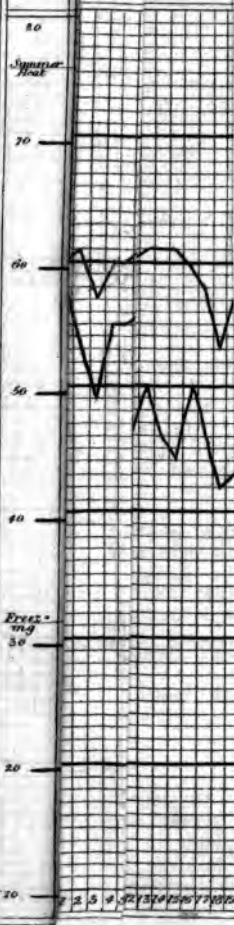

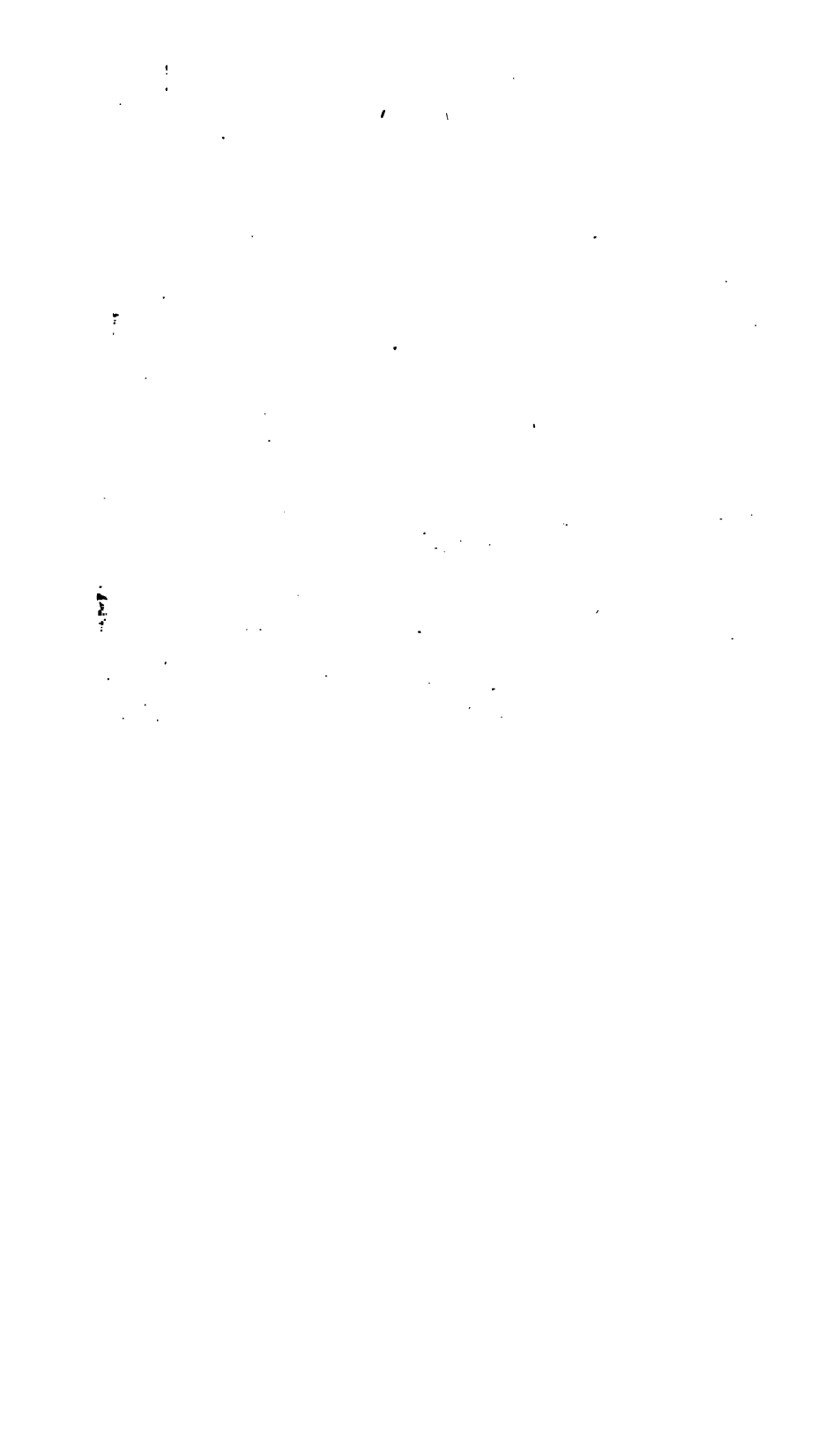

Date.	Wind.	Rain.	Observations.
1816.			
July 18	WSW	0.24	Heavy showers.
19	S	1.35	A truly wet day; high wind, and thick weather.
20	S to E	0.64	Misty morn; cloudy and fair afternoon.
21	SE to SW	0.47	Heavy showers.
22	SW to S	6.35	Cloudy morn; rain and high wind, afternoon.
23	WNW to S	0.05	Light showers, morn; cloudy and fair afternoon; cloudy at night.
24	Var.	0.18	Cloudy and fair morn; showers, afternoon.
25	WNW		Cloudy and fair.
26	Var.		Cloudy morn; ditto and fair day; cloudy at night.
27	NW		Cloudy and fair; cloudy at night.
28	NW		Cloudy and fair.
29	NW	0.26	Cloudy morn; thunder and showers, afternoon; distant lightning at night.
30	Var.		Cloudy and fair.
31	Var.	0.26	Ditto morn; rain, afternoon.
			7.44 inches.

Barometer: Highest	29.94 inches	Wind.
Lowest.....	29.20	Var.
Mean	29.574	S
Thermometer: Highest	70°	WSW
Lowest.....	44	Var.
Mean	55.922	

AUGUST.

August 1	NW		Cloudy and fair.
2	Var.	0.32	Ditto morn; heavy rain, afternoon.
3	Ditto.		Fog, morn; cloudy and fair day.
4	Ditto.	0.06	Ditto, ditto; shower, afternoon; cloudy and fair eve.
5	WNW		Fair.
6	S	0.44	High wind, and heavy rain.
7	S	0.66	Ditto, ditto.
8	WNW	0.07	Misty morn; cloudy and fair day.
9	WNW	0.04	Showers early, morn; ditto, ditto, day.
10	WNW to SSW		Cloudy and fair morn; cloudy, and high wind, afternoon.
11	SSW to W	0.13	High wind; thick weather; small rain.
12	W to WN W	0.09	Small rain, early; cloudy day; fair at intervals.
13	W to S		Cloudy and fair morn; fair afternoon; cloudy at night.
14	ESE to S	0.15	High wind, and showers.
15	SW to WNW	0.39	Heavy showers.
16	NW	0.12	High wind, and showers.
17	W	0.17	Ditto, ditto.
18	WNW		Ditto; cloudy and fair.

Date.	Wind.	Rain.	Observations.
1816.			
August 19	Var.		Cloudy and fair.
20	NW		Ditto, ditto; a slight shower.
21	S to WNW		Cloudy and fair.
22	NW		Ditto; cloudy at night.
23	NW to S		Ditto, ditto.
24	S to W		Cloudy and fair.
25	Var.		Fair day; cloudy at night.
26	NW to E		Fair.
27	ENE		Cloudy and fair; cloudy at night.
28	ENE		Cloudy morn; fair day.
29	NW		Fair morn; cloudy and fair afternoon; cloudy at night.
30	NW to SSW		Cloudy and fair morn; cloudy afternoon.
31	NW	0.44	High wind, and heavy showers; a boisterous day.
			3.07 inches.

Barometer: Highest	30.22 inches	Wind. Var.
Lowest	29.18	Ditto
Mean	29.923	
Thermometer: Highest	71°	Ditto
Lowest	42	NW
Mean	58.451	

SEPTEMBER.

Sept. 1	NW	0.08	High wind; cloudy and fair morn; showers, afternoon; a truly cold day.
2	NW	0.05	Showers, morn; cloudy and fair day.
3	NW	} 0.31	Cloudy and fair; showers, afternoon.
4	NW		Showers early, morn; high wind; cloudy and fair day.
5	NW	} 0.07	Cloudy and fair day; fair at night.
6	Var.		Fog, morn; misty day.
7	Ditto.		Ditto, ditto; cloudy day; misty at night.
8	SW to NW	} 0.76	Cloudy and fair; cloudy at night.
9	SW to SSW		Thick weather; heavy rain; a gale at night.
10	WSW	} 0.18	Cloudy and fair, with showers.
11	WSW		Ditto, ditto.
12	SW		Ditto.
13	S to E	} 0.45	Fair morn; cloudy and fair afternoon.
14	S		Heavy showers early, morn; thick weather during the day.
15	S to SSE		A misty day.
16	NE		Ditto.
17	ENE		Fair morn; cloudy and fair afternoon.
18	W to S		Fog, morn; fair afternoon; cloudy at night.
19	E		Cloudy morn; ditto and fair afternoon; fair at night.
20	E		High wind; cloudy.

Date.	Wind.	Rain.	Observations.
1816. Sept. 21	S to NW	0-30	Heavy showers, morn; cloudy and fair afternoon; cloudy at night.
22	ENE		Cloudy and fair morn; fair day.
23	ENE		Fair.
24	Var.		Ditto and cloudy.
25	Ditto.		Ditto, ditto.
26	SW to NW		Ditto, ditto; cloudy afternoon.
27	NW		Thick weather, morn; cloudy and fair afternoon.
28	W	} 0-18	Showers, morn; cloudy day.
29	SSW to WNW		A gale, and showers; cloudy and fair at night.
30	W	0-10	High wind, and showers.
			2.48 inches.

Barometer: Highest.....	30.22 inches	Wind.
Lowest.....	29.45	Var.
Mean.....	29.876	NW
Thermometer: Highest.....	71°	Var.
Lowest.....	40	NW
Mean.....	56.416	

OCTOBER.

Oct. 1	SW to WNW	0-54	High wind, and heavy showers, morn; thick weather, afternoon.
2	SSW to WNW	0-12	A gale, and showers, morn; cloudy day.
3	NW to S	} 0-20	Cloudy morn; misty day.
4	SSW		Misty, small rain.
5	SSW to SE	0-64	Heavy rain.
6	SE to E	} 0-28	Cloudy morn; showers during the day.
7	E		Showers.
8	ESE		Cloudy day; high wind at night.
9	E	0-24	High wind, and showers.
10	E to WNW		Cloudy and fair morn; cloudy afternoon.
11	NW to NNW		Cloudy and fair.
12	ENE to ESE		Fair day; cloudy at night.
13	E to SSE		Misty morn; cloudy day.
14	NW to SW		Fog, morn; cloudy and fair day.
15	SSE		Fair day; cloudy and fair at night.
16	SSE to S	} 0-20	Cloudy day; showers at night.
17	NW		Fair morn; showers, afternoon.
18	NW		Showers early, morn; fair day.
19	NW to W		Cloudy and fair morn; misty afternoon; cloudy eve.
20	NW	0-11	Cloudy morn; cloudy and fair afternoon; showers, eve.
21	NW		High wind, morn; cloudy and fair day; a calm at night.
22		} 0-08	Cloudy and fair morn; showers afternoon.
23	ENE to S		Fair morn; showers, afternoon; wind at night.

Date.	Wind.	Rain.	Observations.
1816.			
Oct. 24	W	0-99	High wind, and heavy rain.
25	WNW	} 0-92	A gale early, morn; heavy showers of hail and rain during the day.
26	S to E		High wind, with ditto.
27	E	0-25	Ditto, with ditto of rain.
28	ENE to SSW	0-07	Occasional rain; a heavy gale at midnight from SSW for half an hour only, which drove two vessels on shore in the harbour, when it abated, and veered round to the E.
29	E	} 0-29	Showers.
30	E to S		Ditto.
31	SSE		Heavy ditto.
		5-25 inches.	

Barometer: Highest.....	30-15 inches	Wind.	SSE
Lowest.....	29-02		E to S
Mean.....	29-710		
Thermometer: Highest.....	67°	Var.	Ditto
Lowest.....	35		
Mean.....	52-935		

NOVEMBER.

Nov. 1	NW	0-07	Cloudy and fair morn; showers, afternoon; cloudy at night.
2	E to W	0-19	Heavy rain.
3	Var.		Fair morn; cloudy and fair afternoon.
4	NE		Cloudy and fair morn; fair afternoon.
5	Var.		Fair morn; cloudy and fair afternoon.
6	NW	0-20	Showers.
7	NW		Cloudy and fair; some sleet at noon.
8	ENE	} 0-39	Ditto, ditto, day; high wind, and heavy showers, at night.
9	SW to W		A gale early, morn; high wind, and snow showers, during the day.
10	NW	} 0-65	Ditto, ditto, ditto.
11	E to W		Snow showers (lay on the ground from six to eleven, a. m.); heavy rain, afternoon and night.
12	NW		A violent storm.
13	WNW		High wind, and thick weather.
14	WNW	} 0-33	Ditto; showers.
15	NW		Ditto; ditto of rain, hail, and sleet.
16	NW		A very white frost; fair day.
17	WNW to SSW	} 0-30	Ditto; misty at night.
18	WNW		Showers early, morn; cloudy and fair day.
19	WNW to S	} 0-17	Cloudy day; showers, and high wind, at night.
20	S to SSE		Cloudy morn; high wind, and showers, afternoon.

Date.	Wind.	Rain.	Observations.
1816.			
Nov. 21	ESE	} 0.51	High wind; cloudy and fair.
22	E		Ditto, ditto.
23	E		Ditto; fair.
24	E		Hoar frost; fair morn; cloudy and fair afternoon.
25	S to W		Cloudy morn; misty afternoon.
26	NW		Very heavy showers early, morn; cloudy and fair day.
27	ENE to W		Cloudy and fair day; cloudy at night.
28	WNW to NE		Cloudy day; fog at night.
29	ENE		Fog, morn; fair day.
30	ENE		Fair day; cloudy, and a hale, at night.
3.41 inches.			

Barometer: Highest.....	30.67 inches	Wind. ENE
Lowest.....	28.91	SW
Mean.....	29.778	
Thermometer: Highest.....	54°	Var. NW
Lowest.....	26	
Mean.....	41.666	

DECEMBER.

Dec. 1	NE		Cloudy morn; cloudy and fair afternoon; fair at night.
2	NW		Ditto, ditto; ditto, ditto; fog at night.
3	ENE		Cloudy.
4	SE		Ditto.
5	SE to WNW	0.40	A gale, and cloudy morn; heavy rain, afternoon.
6	WNW	0.28	Cloudy and fair morn; heavy rain, and high wind, afternoon.
7	WNW to WS	0.20	Heavy showers of rain and hail.
8	NW		Cloudy and fair.
9	SE to NW	0.64	High wind, and heavy rain.
10	Var.	0.28	Ditto; ditto shower.
11	W	0.26	Ditto; ditto hail ditto.
12	ENE, WSW	0.48	Heavy rain, and a violent storm.
13	W	0.24	Heavy showers of hail and rain; high wind.
14	W to S	0.95	Showers, morn; a storm, and heavy rain, afternoon and night.
15	W	0.12	High wind, and hail showers.
16	Var.		Cloudy and fair; a light shower.
17	W	0.45	Heavy rain, morn; cloudy and fair afternoon.
18	WNW to ENE	0.04	Showers, morn; fair afternoon; cloudy eve.
19	WNW to E		Fair.
20	E to N		Ditto.
21	NNW to ENE		Ditto; high wind.
22	ENE to WNW		Ditto morn; clo
23	W to WNW	0.10	Ditto, ditto; ai

Date.	Wind.	Rain.	Observations.
1816.			
Dec. 24	WNW to W	0.12	High wind; cloudy, and light rain.
25	SW to S	0.05	Fair morn; light showers, afternoon.
26	S to SSW	0.45	A gale, with showers of hail and rain.
27	NW	0.11	Hail showers.
28	SW to WNW	0.39	Heavy showers, and a gale of wind.
29	W	0.28	Cloudy and fair morn; heavy rain, afternoon and eve.
30	S	1.40	Heavy rain; high wind.
31	SW to NW	0.38	Cloudy morn; heavy showers, afternoon and evening.
		7.62 inches.	

Barometer: Highest.....	30.64 inches	Wind.
Lowest.....	28.80	NE
Mean.....	29.751	WSW, a
Thermometer: Highest.....	71°	great storm.
Lowest.....	25	Var.
Mean.....	39.967	NW

ARTICLE VIII.

Biographical Sketch of Ventenat.

VENTENAT was born at Limoges on March 1, 1757. His parents destined him for the ecclesiastical state, and placed him, at the age of 15 years, in the congregation of the canons of St. Genevieve, where he pursued his studies with so much ardour, and at the same time possessed so many advantages of voice and person, that his superiors predicted that he would have risen to distinguished eminence in the clerical profession. But he soon found the situation in which he was placed little adapted to his scientific and inquiring turn of mind; and, renouncing the advantages of interest which it held out to him, he resolved to devote his life to study, and particularly attached himself to that of botany.

In the year 1788 he came to London, for the purpose of procuring books; and on his return was wrecked on the coast of France, and escaped from the most imminent danger. He was the only one of the crew that was saved; and he owed his life to his dexterity as a swimmer, and to his presence of mind, which never forsook him in the utmost extremity. It seems that his health never entirely recovered from the violent exertion which he was obliged to use on the occasion. He continued, however, diligently to prosecute his favourite study, and indeed seems to have devoted his *time and attention almost exclusively to it.* His first botanical essay

was published in 1792, in the first volume of the *Magasin Encyclopedique*, in which he ventured to combat the theory of Hedwig on the fecundation of mosses. His first work of any considerable size was published in 1797, under the title of *Principles of Botany*, extracted from a course of lectures which he delivered at the Lyceum. This work he afterwards considered so imperfect, that he took great pains to have it suppressed; but, notwithstanding all his exertions, it was translated into German, "a language into which they translate every thing."

Two years afterwards he remodelled the work, and published it in an improved form, under the title of *View of the Vegetable Kingdom*. It is professedly founded upon the *Genera Plantarum* of Jussieu; but by retrenchments in some parts, and additions in others, it assumed altogether a more popular cast, and was better adapted for general use. It was, however, more by works on descriptive botany that the great reputation of Ventenat was raised, and on which it must ultimately rest. In his splendid publications of the figures of plants are united all the elegances of the arts of painting and engraving, accompanied by exact descriptions and learned observations. In productions of this kind he decidedly surpassed all his predecessors, and has scarcely been equalled by any of his contemporaries. The first of Ventenat's magnificent works was his account of the plants in the garden of Cels. The reputation which it acquired obtained for the author the patronage of the Empress Josephine, who engaged him, in connexion with Redouté, to describe and figure the rare plants in the gardens of Malmaison. The result of their united labours produced a work still more superb than the former. Ventenat's health, however, which had never recovered the shock of the shipwreck, now began seriously to decline; and various incidental circumstances, probably aggravated by an excessive ardour in all his pursuits, and a degree of natural irritability of temper, acted unfavourably upon his constitution, and produced a disease of the spleen, of which he died the 13th of August, 1808.

Ventenat must be considered as holding a distinguished place among the botanists of his age; and in the figuring and describing of plants will perhaps never be excelled. His merit, however, was rather that of a very able artist, and an accurate observer, than of a profound scientific botanist; and it is probable that his reputation with posterity will scarcely maintain the rank which it bore among his contemporaries.

(D. M. 7
 10 L.
 10 L.
 10 L.
 10 L.
 7
 7
 7

ARTICLE IX.

Account of the Ballston Waters.

The waters of Ballston have been long famous in America for their powerful medicinal effects; and we have been favoured by a correspondent with some account of them, from which we extract the following particulars:—

At the request of Mr. Livingston, a quantity of the water was sent him, during his residence in France, which he gave for examination to “one of the most celebrated chemists” of that country, whose name, however, is not mentioned. The following is the result of the examination:—

“*L'Analyse de l'Eau que M. L. m'a donné à analyser, contenant par Bouteille de 25 Onces.*

SAVOIR.

1. Acide carbonique (air fixe)	3	fois son volume
2. Muriate de soude (sel marin)	31	grains
3. Carbonate de chaux sursaturé	22	grains
4. Muriate de magnésie (sel marin à base de magnésie)	12 $\frac{1}{2}$	grains
5. Muriate de chaux (sel marin à base de chaux)	5	grains
6. Carbonate de fer	4	grains

“Aucune eau minérale de notre continent n'est aussi riche en substances salines de ce genre; celle de Vichy, qui a une grande réputation, ne contient par bouteille qu'un dixième de grain de carbonate de fer, tandis que celle dont nous donnons l'analyse en contient 4 grains. C'est au fer que ces espèces d'eaux acidulées doivent leur qualités toniques et déboustruantes.

“A la dose de deux bouteilles l'eau d'Amérique doit être un léger purgatif qui convient dans tous les cas, ou il est nécessaire d'évacuer la bile, et donner du ton au système vasculaire; cette eau véritablement précieuse pour une infinité des maladies, semble avoir été formée par la nature, dans les meilleures proportions, pour guerir les pales couleurs, et les suppressions. On ne doute point que cette eau ne devienne un objet important de commerce.”

With respect to the constituents of the water, we may conceive that the above account of them refers to the substances which were obtained by analysis, and not to the state in which they actually exist in the water. Its chief peculiarity consists in the large quantity of iron which it contains, according to this analysis, the carbonate composing $\frac{1}{8}$ part of the whole of the solid contents. If we estimate the composition of this salt, in round numbers, at

about two parts of acid to three of the protoxide, $\frac{1}{10}$ of the residuum will consist of the protoxide of iron, and the residuum being about 93 grains in a wine pint, this quantity of the water contains about three grains of the protoxide.

The medical virtues attributed to these waters are those of a powerful tonic and deobstruent, and may be supposed to depend principally upon the great quantity of iron which they contain, and in some degree also on the neutral and earthy salts. The quantity of the muriate of lime in these waters is so considerable as to induce us to attribute some important effects to this ingredient, independent of the general purgative quality which will result from the combined operation of the whole.

ARTICLE X.

ANALYSES OF BOOKS.

I. *An Essay on the Chemical History and Medical Treatment of Calculous Disorders.* By Alex. Marcet, M.D. F.R.S. &c. &c.

THE formation and deposition of various kinds of calculi, in different parts of the living body, constitute a series of actions that form an immediate connexion between the sciences of chemistry and medicine. An analysis of this work will, therefore, properly belong to the *Annals of Philosophy*; and it will be the more necessary to give an account of it, as the author has not merely afforded us a very correct and perspicuous view of what had been previously done by others in this department, but has also furnished us with some new facts, and described some new substances, which had not been before noticed.

After detailing an account of the symptoms which characterize the presence of calculi in the different organs where they are usually found, and some curious facts respecting the comparative prevalence of calculous complaints in various districts, we come to the chemical part of this work, in which the author gives a description of the different species of urinary calculi, of their external characters, and chemical nature, and afterwards forms a classification of them. Many writers on this subject had arranged calculi according to the parts of the body in which they were deposited; but there seems to be no proper ground for forming any division of them from this circumstance. In whatever organ they are deposited, they probably all originate from the same cause, and it seems in a great measure accidental whether they are lodged in one part or another. The only correct principle of classification is their chemical composition; and this is the only mode which can be of any utility, either as affording us any chance of arriving at a correct theory of their formation, or any probable means of removing them.

by the aid of medicine. The external characters of calculi are described in detail: their form, size, colour, the nature of their surfaces, their specific gravity, odour, internal structure, the nucleus upon which the bulk of the calculus is often deposited, and the alternation of layers which they generally exhibit. We have next a sketch of the discoveries that have been successively made on these bodies, from the first rude attempts of Vanhelmont to ascertain their nature, to the more correct experiments of Scheele, Fourcroy, and Wollaston. The author has shown a proper anxiety to render to each chemist his due degree of merit; and has in a spirited, but certainly very correct manner, vindicated the fame of his friend Dr. Wollaston against the encroachments of Fourcroy, who most unaccountably published as his own discovery a number of important facts respecting urinary calculi which had been most explicitly announced two years before in the Philosophical Transactions by the English chemist.

The substances which have been hitherto discovered in urinary calculi are five: lithic or uric acid, phosphate of lime, ammoniaco-magnesian phosphate, oxalate of lime, and cystic oxide. These substances are, however, many of them at least, seldom found in a separate or pure state, but they afford certain combinations sufficiently constant to enable us to form our arrangement. Proceeding upon these principles, Dr. Marcet forms them into nine classes, under the following titles and designations:—1. The *lithic* calculus. 2. The *bone-earth* calculus, principally consisting of phosphate of lime. 3. The *ammoniaco-magnesian phosphate*, or calculus in which this triple salt obviously prevails. 4. The *fusible* calculus, consisting of a mixture of the two former. 5. The *mulberry* calculus, or oxalate of lime. 6. The *cystic* calculus, consisting of the substance called by Dr. Wollaston cystic oxide. 7. The *alternating* calculus, or concretion composed of two or more different species, arranged in alternate layers. 8. The *compound* calculus, the ingredients of which are so intimately mixed as not to be separable without chemical analysis. 9. Calculus from the *prostate* gland.

Each of these species is then accurately described: we have an account of their discovery, of the circumstances under which they are most frequently generated, and of the action of chemical reagents upon them. In the review of these substances which is thus presented to us we cannot but be forcibly struck with the great obligations under which we lie to Dr. Wollaston. To him we are indebted for our knowledge of the existence of phosphate of lime, as constituting a distinct species of calculus; and the same remark applies to the triple calculus. With respect to the fusible calculus, although the late Mr. Teunant first discovered that it differed from the lithic acid of Scheele, yet it is to Dr. Wollaston that we are to ascribe our correct knowledge of its nature; and the same remark applies to the mulberry calculus and the cystic oxide. Except, therefore, the original discovery of Scheele, respecting the lithic

acid, we owe to our learned countryman the correct knowledge of all the primary compounds of the calculi that are as yet distinctly known.

Dr. Marcet may seem to have deviated from his plan in forming the ninth species, the calculus of the prostate gland, from its situation; but we learn that the calculi which are found in this organ possess a peculiar composition, or rather always exhibit the same chemical properties. For this fact we are again indebted to Dr. Wollaston, who found "that they all consist of phosphate of lime, not distinctly stratified, and tinged by the secretion of the prostate gland." Like the cystic calculi, which consist of phosphate of lime, the earthy salt is in its neutral state, without the redundancy of lime which exists in the earth of bones.

The author has hitherto been principally occupied in conveying to us, under a correct and commodious form, the information that had been previously afforded by others; but in the next chapter we enter upon new ground. We have "an account of two calculi, which cannot be referred to any of the species hitherto described." The first of these seems to have the most analogy or resemblance to the cystic oxide, but it possesses sufficient marks of distinction; for we are informed that the new substance forms a bright lemon residuum on evaporating its nitric solution, and is formed of laminæ, whereas the cystic oxide is not laminated, and leaves a white residue from the nitric solution. Although they are each of them soluble both in acids and alkalis, yet the proportion of effect is different in the two cases, the oxide being rather more soluble in alkalis, and considerably more so in acids, than the new substance. Upon the whole, there seems no doubt of its being really a calculus of a new and peculiar nature. On this account Dr. Marcet has conceived it necessary to give it an appropriate name, and he has chosen the property which it possesses of forming the yellow residuum from the nitric solution as one of its most specific and distinguishing properties, and has accordingly denominated it *xanthic oxide*. The other new calculus was found to possess properties exactly similar to those of the fibrine of the blood, was no doubt formed by a deposit from this fluid, and accordingly has received the appellation of *fibrinous calculus*.

The sixth chapter is on the analysis of urinary calculi, in which the object of the author is not so much to propose any new methods of examining these bodies, or to detail any discoveries which he has made upon the subject, as to point out to medical practitioners a few simple tests and easy processes by which they may ascertain the prevailing nature of the concretion, so far as concerns the kind of remedies to be employed. Tests are therefore given for each of the species above enumerated, and directions given for their application, which seem to be well adapted to the proposed object. We have a number of interesting facts in the seventh chapter, on some other kinds of animal concretions, which do not belong to the urinary passages. These have been occasionally found in most of

the viscera, the salivary glands, the pancreas, the spleen, the lungs, and other parts; but those of the most frequent occurrence, and most importance in medical practice, are concretions in the intestinal canal. Of these many varieties are described, obviously consisting, in a great measure, of substances taken into the stomach, and detained, or accidentally mixed with other matters, and moulded into the round form by the action of the bowels. One of the most remarkable of the intestinal calculi is a species, which appears not to be uncommon in Scotland, consisting of concentric layers of a brown velvety substance and a white earthy matter. The white matter appeared to be composed of a mixture of the two phosphates, but the brown substance was more puzzling: its nature, however, was discovered by the sagacity of Dr. Wollaston, who found it to be formed of minute vegetable fibres, derived from a kind of beard, which exists at one extremity of the seed of the oat.

It would be scarcely consistent with the nature and object of the *Annals* to follow Dr. Marcet through his remarks on the medical treatment of calculous disorders. Enough has been said to point out the nature of the work, and the manner in which it has been executed: it may be characterized as exhibiting a correct and elegant view of the present state of our knowledge on the subject of calculi, and likewise as affording some valuable additions to it. It is accompanied by some very excellent plates, representing the different species of concretions, and the apparatus employed in their analysis.

II. *Philosophical Transactions of the Royal Society of London, for the Year 1817, Part I.*

This Half-Volume contains the following Papers.

1. An Account of the Circulation of the Blood in the Class Vermes of Linnæus, and the Principle explained in which it differs from that in the higher Classes. By Sir Everard Home, Bart. V. P. R. S.

2. Observations on the *Hirudo Vulgaris*. By James Rawlins Johnson, M. D. F. L. S., &c.

3. On the Effects of Galvanism in restoring the due Action of the Lungs. By A. P. Wilson Philip, Physician in Worcester.

4. An Account of some Experiments on the Torpedo Electricus, at La Rochelle. By John T. Todd, Esq.

5. A Description of a Process, by which Corn tainted with Must may be completely purified. By Charles Hatchett, Esq. F. R. S.

6. Observations on an Astringent Vegetable Substance from China. By William Thomas Brande, Esq. Sec. R. S.

7. Some Researches on Flame. By Sir Humphrey Davy, LL. D. F. R. S. V. P. R. I.

8. Some new Experiments and Observations on the Combustion

of gaseous Mixtures, with an Account of a Method of preserving a continued Light in a Mixture of inflammable Gases and Air without Flame. By Sir Humphrey Davy, LL. D. F.R.S. V. P. R. I.

9. De la Structure des Vaisseaux Anglais, considérée dans ses derniers Perfectionnements. Par Charles Dupin, Correspondant de l'Institut de France, &c.

10. On a new fulminating Platinum. By Edmond Davy, Esq. Professor of Chemistry, and Secretary to the Cork Institution.

11. On the Parallax of the fixed Stars. By John Pond, Esq. Astronomer Royal, F. R. S.

Appendix to Mr. Pond's Paper on Parallax.

12. An Account of some Fossil Remains of the Rhinoceros, discovered by Mr. Whitby, in a cavern inclosed in the lime-stone Rock, from which he is forming the Break-water at Plymouth. By Sir Everard Home, Bart. V. P. R. S.

Some account of the contents of these Papers has already been given, in the History of the Proceedings of the Royal Society; * the papers of Sir H. Davy, however, are so interesting, and contain so much curious and important matter, that it will be proper to give a more complete analysis of them.

In his former researches, the results of which have been laid before the public, the author has shown that the explosion of gaseous mixtures, however inflammable, may be prevented, by any circumstance which tends to reduce their temperature; and it was from this consideration that he was led to his beautiful discovery of the wire gauze lamp, as a safe method of illuminating coal-mines. In a subsequent train of experiments he established the position that the intensity of the light of flame chiefly arises from the ignition of particles of solid matter, which are thrown off from the burning body, and from this he infers that the light and heat generated in this process are, to a certain degree, independent phenomena.

In detailing the account of his recent labours on the subject of flame, the author proposes to arrange his observations under four heads. In the first section he considers "The Effect of Rarefaction by partly removing the Pressure of the Atmosphere upon Flame and Explosion." This point has lately been examined by M. de Grotthus; but it is unnecessary to dwell upon his conclusions, because the experiments of Sir H. Davy have conducted him to very different results. It was found that a small jet of hydrogen, proceeding from a fine glass tube, and forming a flame of about $\frac{1}{2}$ of an inch in height, when introduced into a receiver, containing from 200 to 300 cubic inches of air, had the flame enlarged as the receiver was gradually exhausted, until the pressure was between four and five times less than that of the atmosphere; and that when it became between seven and eight times less, it was

* *Annals*, viii. 458; ix. 149, 229, 239.

extinguished. When a larger jet was used, the flame continued until the atmosphere was rarefied ten times, and it was observed that, in this case, the point of the tube was raised to a white heat. It therefore occurred to the author that the continuance of the combustion, under a great degree of exhaustion, in the latter experiment, depended upon the higher temperature to which the gas was subjected on issuing from the orifice of the tube; and this conjecture was confirmed by observing the effect that was produced by coiling a platinum wire round it, for with this addition, the small jet continued to burn until the pressure was reduced 13 times. Hence it follows, that hydrogen is extinguished in a rarefied atmosphere, not from the deficiency of oxygen, or at least not directly from this cause, but in consequence of the heat produced not being sufficient to support the combustion. The necessary degree of heat seems to be that which communicates visible ignition to metal; and this is also the temperature which hydrogen requires for its combustion at the ordinary pressure of the atmosphere.

From this fact respecting hydrogen, Sir H. Davy was induced to form the general conclusion, that combustible bodies which require the least heat for their combustion, as well as those which generate the most heat during this process, should be capable of burning in the most rarefied air; and he found this conclusion to be justified by every experiment which he performed for the purpose of putting it to the test. The experiment was tried upon olefiant gas, which, with the small jet and the platinum wire, burned until the pressure was diminished between 10 and 11 times, the flame of alcohol and a wax taper only until the pressure was diminished seven or eight times; light carburetted hydrogen, when the pressure was reduced to $\frac{1}{4}$; carbonic oxide when it was $\frac{1}{5}$; and sulphuretted hydrogen when it was $\frac{1}{7}$. Sulphur, on the contrary, requiring a lower temperature for its combustion, bore a diminution of pressure equal to $\frac{1}{20}$. Van Marum has shown that phosphorus will burn in an atmosphere rarefied 60 times, and phosphuretted hydrogen produces a flash of light in the most perfect vacuum of an air pump. On the same principle it was found that oxygen and chlorine, which explode at a lower temperature than oxygen and hydrogen, and evolve more heat, would bear a greater degree of rarefaction; the latter will not explode by the electric spark when rarefied 18 times, whereas the former combine when the exhaustion is $\frac{1}{24}$. Various experiments are then detailed, which prove that by sufficiently heating substances, they may be caused to burn in air rarefied to a degree which would not otherwise support their combustion, and this appeared to be the case in whatever way the heat was communicated.

The author next performed a series of experiments, the object of which was to determine the quantity of heat generated by the combustion of the different inflammable gases. For this purpose similar quantities of the gases in question were burned in an apparatus so contrived, that the heat was applied to the bottom of a

small cup filled with olive oil, and the increase of temperature in the oil, during a given time, was carefully noted. Calculating from the elevations of temperature actually produced, and the quantities of oxygen consumed, the heat produced by the combustion of the gases was found to coincide with the conclusions deduced from the former set of experiments. Hydrogen was found to be the gas which produced most heat, and the gaseous oxide of carbon the least, in the proportion of about 26 to 6.

The second section is "On the Effects of Rarefaction by Heat on Combustion and Explosion." M. de Grotthus, in the experiments which have been already alluded to, states that rarefaction by heat destroys the combustibility of gaseous mixtures, a statement which is indirectly opposed by the facts and experiments that have already been brought forward, but which Sir H. Davy made also the direct subject of experiment. He found that he was not able to produce a greater degree of expansion by heat in a glass vessel than 2.5, whereas M. de Grotthus speaks of a mixture of air and hydrogen being expanded to four times its original bulk. But it is inferred that this extraordinary degree of expansion depended upon a portion of steam being mixed with the gases, and to this, rather than to the expansion of the air, it is that we ought to attribute its not exploding, as was the case in this experiment. Sir H. Davy, however, found that the rarefaction of a gaseous mixture rendered it explosive at a lower temperature, a result which might naturally be expected as less of the communicated heat would be expended in raising the temperature of the substance. In the course of his experiments he found that mixtures of oxygen and hydrogen confined in tubes, and exposed to a heat between that of the boiling point of mercury, and what makes glass luminous in the dark, combined silently and without emitting any light. By a proper management of the temperature it seems probable that all substances, which are capable of combustion, may be made to combine in this gradual manner.

The author takes occasion to controvert an opinion, which has been supported by Dr. Higgins, M. Berthollet, and others, that the electric spark causes the explosion of gaseous bodies, in consequence of the sudden expansion of that part to which the electricity is immediately applied. He found by a direct experiment, that an increased temperature, and not compression, produced the explosion of these mixtures; and from this he draws the general conclusion, that "the heat given out by the compression of gases is the real cause of the combustion which it produces, and that at certain elevations of temperature, whether in rarefied or compressed atmospheres, explosion or combustion occurs; i. e. bodies combine with the production of heat and light."

The third head is "On the Effects of the Mixture of different Gases in Explosion and Combustion." In order to ascertain these effects he procured a mixture of two parts hydrogen and one part oxygen by measure, and diluting them with various proportions of

different gases, he tried their inflammability by the electric spark. The general result is, that very different quantities of the gases employed prevented the inflammation of the mixture; it required 11 parts of nitrous oxide, and only $\frac{1}{4}$ of olefiant gas; and in general the author observes, they show that other causes, besides density and capacity for heat, are concerned in the operation. An observation of Mr. Leslie's is alluded to, in which he found that hydrogen has a much greater power in abstracting heat from solids than air or oxygen have; Sir H. Davy verified this by his own experiments, and extended his researches to various other gases, and he concludes from them that elastic fluids abstract heat from solids "in some inverse ratio to their density;" that gases have different powers of conducting heat, which seem to be specific or peculiar to themselves; and it is inferred that those which are the best conductors of heat act the most powerfully in preventing explosion, by carrying off the heat, and thus diminishing the temperature below the necessary degree. This abstraction of heat in gaseous mixtures cannot depend, as it does with respect to solids, merely upon the mobility of the particles, but upon the "power which they possess of rapidly abstracting heat from the contiguous particles, depending upon the simple abstracting power by which they become quickly heated, and their capacity for heat, which is great in proportion as their temperatures are less raised by this abstraction."

This abstracting power of the different elastic fluids is found to operate uniformly with respect to the different species of combustion, so that those explosive mixtures, which require least heat for their combustion, also require larger quantities of the different gases to prevent the effect. It is observed that the cooling power of gases in preventing combustion must necessarily increase with their condensation, and diminish with their rarefaction; at the same time the quantity of matter entering into combustion in given spaces is relatively increased and diminished. By a direct experiment the author found that the condensation of atmospherical air does not materially increase the heat of flame, as it was before observed that rarefaction did not materially diminish it; from which the general inference may be drawn, that in all degrees of atmospherical pressure in which life can be maintained, the atmosphere still retains the same relation to combustion.

The fourth part of the paper is entitled, "Some general Observations, and practical Inferences." The author remarks that all his subsequent researches tend to confirm his former ideas concerning the operation of the wire-gauze coverings of the lamps, that it depends upon the gauze cooling each portion of the elastic matter that passes through it, so as to reduce its temperature below the exploding point. The diminution of the temperature must be in proportion to the smallness of the mesh and the mass of the metal; and the power of the tissue to prevent explosion must depend upon the degree of heat required to produce the combustion required

with that acquired by the metal. These principles are illustrated in a variety of ways; and a number of experiments are adduced in support of them; but as they principally refer to what has been already stated, it will not be necessary to give an abstract of them in this place.

Sir H. Davy's second paper may be regarded as an appendix to the one which has been analyzed, and is principally founded upon the fact stated above, that combustible bodies may be made to combine silently, at a temperature below ignition, and produce the same chemical compounds, as when exposed to the temperature necessary for combustion. But although in these combinations there was no rapid evolution of caloric, it occurred to the author that heat must be extricated; and the quantity was in fact found to be considerable enough to preserve a wire of platinum in a state of ignition, and to keep up the further combustion of the gases. The first experiment of this kind was made with a mixture of air and coal gas, which the author was examining for the purpose of finding out the degree in which different proportions of these bodies were affected by an increase of temperature. It was found that as long as the metallic wire remained at a temperature which produced a visible ignition, the combination of the gases went on, and that, after the wire was extinguished, the gaseous mixture was no longer inflammable. It also appeared that a degree of heat much below ignition was sufficient for producing this phenomenon, and consequently that the wire might be taken out of the mixture, and cooled in the atmosphere, until it ceased to be visibly red, and yet that when it was again introduced to the gases, it instantly acquired the red heat. A variety of other inflammable compounds, besides that originally made use of, were capable of producing the same effect; and Sir H. Davy mentions one very beautiful way of performing the experiment, in which the vapour of ether is the substance employed. If a drop of this fluid be thrown into a glass, and a portion of platina wire, heated by a poker or a candle, be suspended in the upper part of the vessel, the wire will acquire a glowing heat, and retain it as long as the glass continues to be filled with the vapour. During this silent combustion of the ethereal vapour, it would appear that a peculiar acrid volatile substance is generated, which is possessed of acid properties. The only metals with which this effect can be produced are platinum and palladium; it is remarked that they have low conducting powers, and small capacities for heat, compared with other metals, which properties seem to be the principal causes of the phenomena.

The practical application of the experiment is no less interesting than the fact itself. The author observes that, by suspending coils of wire, or a fine sheet of platinum, above the wick of the lamp in the wire-gauze cylinder, the miner may be supplied with light after the flame is extinguished by the quantity of the fire-damp; and by removing the lamp into different situations, he will be able, by the degree of brilliancy which the metal exhibits, to judge of the e

dition of the atmosphere. It is important to know that while the wire continues ignited, the air is in such a state as to be capable of supporting respiration. We are assured that there is no danger attached to the use of this apparatus, for that if the heated platinum should produce an explosion, the effect will be confined to the space within the wire-gauze cage.

ARTICLE XI.

Proceedings of Philosophical Societies.

ROYAL ACADEMY OF SCIENCES.

Analysis of the Labours of the Royal Academy of Sciences of the Institute of France during the Year 1816.

MATHEMATICAL PART.—By M. le Chevalier Delambre,
Perpetual Secretary.

(Concluded from p. 337.)

On the Relation of the Measure called Pouce de Fontainier with the modern Roman Ounce of Water and the ancient Quinarus; and on the Determination of a new Unity of Measure for the Distribution of Waters, adapted to the French Metrical System. By M. de Prony.

It is some years since the author was invited to present his views on the determination of a new unity of measure, applied to the distribution of water, and proper to replace that known by the name of *pouce de fontainier*, or *inch of water*. To make the experiments which this determination required, he contrived a new apparatus, with which he could undertake the most delicate observations, and the most useful to mechanics and the philosophy of fluids.

The distribution of water in different quarters, and among the inhabitants of a city, reduces itself to make determinate quantities of water arrive at different points in times equally determined. The notion of measure, when applied to the distribution of water, is composed of the idea of a certain volume of fluid, and of that of the time during which that fluid can escape from a reservoir by a determinate mode of flow.

This type of measure is wanting in the new French metrical system, and the addition of it is necessary to render it complete.

There are three things to determine to obtain the suitable relation between the volume of the water and the time of its flow; namely, the diameter of the circular orifice to be made in a plate of vertical wall, the constant charge of water on the summit of that orifice, and the length of the pipe.

The inch of water, or of the *fontainier*, is the quantity of water furnished by a circular orifice of an inch in diameter, pierced in a vertical wall, with a charge of water of seven lines on the centre of the orifice, or of one line on the summit of the orifice. This type of measure has the material fault of leaving undetermined the length of the ajutage, or the thickness of the wall; for the product varies sensibly with this length and thickness. Another fault, no less serious, is the smallness of the charge, which it is almost impossible to regulate according to its just value, and which, however, when altered, has a sensible influence on the produce. This produce being nearly 14 pints (French) in the minute, and the pint containing about 48 cubic inches, it has been pretty generally the custom to make of the inch of water a measure purely nominal of 672 cubic inches per minute, equivalent to 560 cubic feet, or 19.2 cubic metres, in 24 hours.

During an abode of more than two years by the author in the Roman States, he was a good deal occupied with the waters and aqueducts of Rome. The water of the ancient aqueduct is called *Aqua Virgo*; that of the aqueduct constructed or restored by Pope Sixtus Quintus is called *Aqua Felice*; that of Trajan's aqueduct supplies the fountain Paulina. The ounce of water derived from the first of these aqueducts is twice as great as that furnished by the two others. The price of the waters of Paulina and Felice, supposing the quantity equal, is double that of the *Aqua Virgo*. To preserve a nominal value to the price of the unity of the distribution of the water common to the three fountains, the absolute value of these unities has been established inversely as the money values of these waters.

The great ounce of the *Aqua Virgo*, or of the fountain of Trevi, is furnished by an orifice of $\frac{1}{4}$ of a Roman palm, a subdivision which is called *ounce*. The palm is equivalent to 0.2234 metre, and the ounce to 0.0186. To this orifice is fitted a pipe of $\frac{1}{4}$ of a palm, with a charge of water at the centre, which is likewise $\frac{1}{4}$ palms, or 0.2792 metre.

The ounce of the water of Trevi gives a produce of 41.16 cubic metres in 24 hours. The produce of the ounce of water from the other two fountains, then, is 20.58 cubic metres in the same time. It exceeds by 1.38 cubic metre, or by about $\frac{1}{7}$, the produce of the French inch of water.

Here the author indulges some conjectures on the comparison between the Roman ounce of water and the ancient measures of the same kind. In the different aqueducts which distributed water to ancient Rome we see orifices of 25 different sizes. The most common is circular; and it had a diameter of five-fourths of the finger, which made it be called *quinquarius*. But from the distance between the mile-stones of the Appian Way, the ancient Roman foot was 0.29461 metre. Hence the finger, or the 16th of the foot, amounted to 0.01841 metre. The length of the pipe, according to *Frontinus*, ought not to be less than 12 fingers, or 8

meter. He says nothing respecting the charge of water on the orifice. If we compare the modern Roman ounce of water with the ancient quinarius, we find the orifice was nearly the same for both; that is to say, 0.0186 metre for the one, and 0.0184 metre for the quinarius. The respective lengths of the ajutage are 0.28 metre and 0.22 metre; but in the modern modulus the charge upon the centre of the orifice is equal to the length of the ajutage. Hence we may conjecture that this ratio of equality existed also in the ancient quinarius. On this hypothesis, and considering the orifices as equal, the modern Roman ounce would be to the ancient quinarius in the ratio of 53 to 47. Setting out from these determinations, which probably are not far from the truth, we find great mistakes in certain valuations of the Roman waters which have been given to the public.

The ounce of water, then, is an imitation of the ancient quinarius. The *pouce de fontainier* seems to be a less fortunate imitation of the little Roman ounce. The diameter of the orifice was the 12th part of the Roman linear unit. Hence from analogy they chose to take for diameter the 12th part of the French foot. This analogy, extended to the charge on the centre of the orifice, would have given 15 inches, which was impracticable, on account of the enormity of the product. Hence the product was preserved, and they endeavoured to find what charge would furnish this product. This explains the small difference which exists between the *pouce de fontainier* and the little Roman ounce. But the French engineers misunderstood these principles, paying no regard to the length of the ajutage, wisely fixed in the Roman modulus. From augmenting considerably the orifice, in consequence of a misunderstood analogy, they obliged themselves to have a charge a great deal too small; so that the French method of gauging is in every respect very inferior both to the ancient and modern Roman method.

The absolute value of the modulus depends upon the quantity of water for each inhabitant which it is agreed upon to supply. This quantity varies according to situation and custom. At Rome, under Trajan, the nine aqueducts supplied 14,018 quinarii of water, which makes in 24 hours 24,868 *pouces de fontainier*, or 477,466 cubic metres per day—a quantity about double of that which is supplied by the canal of Ourq. Five other aqueducts were constructed soon after. Rome had then 14 aqueducts; and the progressive augmentation of the waters was much greater than that of the population. Modern Rome, with its three aqueducts, and some other resources, receives at present a produce of about 150,000 metres per day. It has been ascertained that in Paris each inhabitant consumes about seven litres of water per day; which at the rate of 600,000 souls makes a total consumption of 4,200 metres per day. But from an examination of the different sources or machines which furnish water to Paris, it appears that the supply amounts to 8,314 cubic metres per day; that is, nearly double what is strictly necessary. Desparcieux re-

quired 20 litres per head. The author conceives that 10 are sufficient; and the rule of Desparcieux might be a limit which would fix the maximum of distribution applicable to private wants. In these determinations are not included emissions in great quantities for objects of utility and decoration, for the arts and manufactures.

If, then, we take 20 cubic metres in round numbers in 24 hours for the value of the inch of water, we come to the small modern Roman ounce; and we shall have this advantage, that in introducing into the decimal system of measures the new unity which was wanting, the different numbers composed of this unity will correspond nearly to the same numbers of the *pouce de fontainier*. It remains, then, to find the size of the orifice, the charge upon the centre, and the length of the ajutage, which will give the most convenient apparatus. Calculation gives 20 millimetres for the diameter of the orifice, and about 17 millimetres for the length of the ajutage. This small length will permit the ajutage to be continued in the thickness of the border which surrounds the reservoir, and none of those accidents which result from the jetting out of the ajutage is to be feared. It will be much more easy to keep the flow perfectly free, and unconnected with the matters which may obstruct tubes of a certain length. The charge on the centre is reduced to five millimetres. To this unity the author thinks that the name of *modulus of water* may be given.

Instruction respecting the Work of M. de Sept-Fontaines, and on the Cubature of Wood in general. By M. de Prony.

“We have, and probably shall long have, many things which will require a comparison of the old and new results deduced from calculations, of which we may desire to make the proof by doubling them according to the ancient measures. The metrical foot, equal to the third of the metre, being a measure admitted, and submitted to the duodecimal division, if we make a beam equal to three metrical cubic feet, subdivided in the same way as the ancient beam, the first tables of M. de Sept-Fontaines will be immediately applicable to that manner of measuring wood. The last five will be the only useless ones.”

These tables having been republished in the *Encyclopedie Methodique*, it has been thought proper to place before them the information which we have just given. But what extent soever we give to these tables, there are questions so complicated that the use of the tables, without ever giving the exactness of direct calculation, will have the disadvantage of leading to operations still more troublesome. For these cases the author gives particular rules, which he facilitates by tables of the factors that enter into the operations. But of all these helps, none is comparable to a table of logarithms. The author points out the advantages of it, and recommends particularly the use of negative characteristics for the fractions. Astronomers usually prefer positive and complementary characteristics; but if the practice of them is more simple and uniform, the rules for them are perhaps less easy to understand. In other respects the two processes are perfectly identical.

The author in tracing this piece of information, which has appeared in the dictionary Deo Boiss et Forts, has had good reason to doubt that it is of any use; but still, as the smallest things we always perceive are based on custom, he has been obliged to order a tour through the mountains of India, by Mr. Alexander de Humboldt.

“The exact measurement of mountains whose summits we cannot attain presents difficulties which depend in a great measure upon the elevation of the grounds surrounding their bases. The platforms on which the chains are elevated are usually too far from the coasts to be able to determine their elevation either by the angles of depression or by levelling. The consequence is, that every measurement of a high mountain is almost always in part barometrical, in part trigonometrical.”

When M. de Humboldt measured the height of Chimborazo on the platform of Tapia, where he had taken his base, he was elevated 2,530 metres above the sea, and the summit of the mountain only 6° 40' above that horizon.

The distance from the mountain was 30,487 metres. More than in the plains of Singun, the base would have had an elevation of 2,900 metres, and the portion determined geometrically would have been only 2,630. Thus travellers are often reduced to points but only the height of mountains above plains of the absolute elevation of which they are ignorant, or to take their measures in plains at a great distance, from which the height is not seen, except under a very small angle, which the refraction may sensibly alter.

These are the obstacles which have deprived us during so long a time of an exact knowledge of the height of the mountains of India. The eastern part of Himalaya (the abode of snow, the Insais of the ancients) is visible from the plain of Bengal, at the distance of 150 English miles. Its height above the plains, then, is not less than 2020 toises. A very high peak of the Himalaya, visible from the town of Patna, was estimated by Col. Crawford at 20,000 English feet above the plains of Nepal, which he supposed elevated 5,000 feet above the level of the sea. Though these measurements are only approximations, we may conclude from them that the mountains of India attain or surpass the elevation of the Cordillieras at Quito.

Mr. Elphinstone informs us that Lieut. Macartney found some peaks of the Hindou Coosh (black mountain, in Persian) elevated 20,493 English feet. Above what valley was the elevation estimated? If it was above the plains of Peshawer, it is probable that but little remains to be added to the height measured by Mr. Macartney. The angle of height was only 1° 30'; the distance was 100 miles. The author himself does not put much confidence in results obtained from such data.

Mr. Webby, Lieutenant to the Corps of Infantry in Bengal, to whom we owe more exact information respecting the course of the Ganges, was charged with making a survey of Kumaon, and of the

province of Nepal. He measured the height of 27 peaks covered with perpetual snow: 20 of these exceeded 20,000 English feet; the lowest is 15,733 feet; the most elevated, 25,669 feet, or 4,012 toises. Mr. Webb adds, that this last is a mile higher than Chimborazo, which he estimates at only apparently 3,014 toises. The following are the heights of the four most elevated peaks of Himalaya:—

Peak.	Feet.	Toises.	Metres.
14th	25669	4013	7821
12th	23263	3637	7088
3d	22840	3571	6959
23d	22727	3553	5925
Chimborazo, according to Humboldt....			6530

The 12th volume of the Asiatic Researches will give us important information on this subject. Already, from an extract published in the Journal of Science and the Arts, we learn that the peak of Chamalasi is seen from different parts of Bengal at 232 miles' distance, which indicates, admitting a mean refraction, a height of 28,000 English feet. Another peak of the Himalaya appears under an angle of 1° 1', at a distance which, from Major Rennel's map, cannot be less than 150 miles. Hence its height is at least 26,000 feet. Lieut. Col. Colebrooke has taken from two stations the angles of the height of a peak, which, if we suppose $\frac{1}{8}$ of refraction, is 22,291 feet higher than the plains of Rohilkhand, and nearly 22,800 feet above the level of the ocean. From some observations of Major Lambton, it appears that the terrestrial refraction in the climate of India is $\frac{1}{4}$: it varies from $\frac{1}{4}$ to $\frac{1}{8}$.

According to the measures of Col. Crawford, Mount Dhaibun is 26,140 feet higher than Cathmandu, which is elevated 4,500 feet above the ocean. Other peaks are 17,819, 20,025, 18,662 feet high. The nearest is at the distance of 170 miles; the farthest of 226 miles. The Dhawalager (white mountain of Himalaya) measured from four different points, and taking three angles of height, was found 26,784, or 27,551 feet, according as we reckon the refraction $\frac{1}{4}$ or $\frac{1}{8}$. The President of the Society of Calcutta finds that, if we suppose the errors of observation and refraction a maximum, and both on the side of excess, this peak is still 26,462 feet above the plains of Gorakhpur, and 26,862 above the ocean.

The Yamunavatri or Jamoutri is 20,895 feet above Nagunghari, which is 5,000 feet above the ocean, making a total of 25,900 feet. A mountain, supposed to be the Dhaibun, is 24,740 feet above the level of the sea.

Another peak, visible at Pilibhit and Jethpur, is 22,786 feet above the level of the sea. Another, seen at Cathmandu, in the direction of the Calabhairavi, is 24,625 feet high. The valley of Nepal itself, in which several bases have been measured, is 4,600 feet above the level of the sea.

add to his journal to p. 75. ...

The highest peak of Himalaya, which, according to the calculations of Lieut. Webb, is only 4,013 toises, or 7,821 metres, is, according to the calculation of the President, 4,201 toises, or 8,187 metres.

It is not accurate to judge of the height of a chain of mountains merely from that of some of the most elevated peaks. One peak of Himalaya exceeds Chimborazo by 1,300 metres; Chimborazo exceeds Mount Blanc by 1,700 metres; Mount Blanc exceeds Mount Perdu by 1,300 metres. But these heights do not give us the ratio of the relative heights of the chains; that is to say, the height of the backs of the mountains upon which the peaks are raised. The parts of these backs which form the passages of the Andes, the Alps, and the Pyrenees, furnish us with a very exact measure of the minimum of height to which mountain chains reach. By comparing these measures with those of Saussure and Ramond, the author estimates the mean height of the back of the Andes of Peru at Quito and in New Granada at 3,600 metres, while the backs of the Alps and Pyrenees rise to 2,300 metres. The mean difference of the Alps and the Cordillieras is, therefore, 500 metres less than would have been believed from the height of their peaks. It would be interesting to know the mean height of the chain of the Himalaya between the meridians of Patna and Lahore.

The snow line does not commence near the equator, in the Andes, below the height of 4,300 metres. In Himalaya, in the latitude of 30° , it is probably as low as 3700 metres. Hence in the New World vegetation extends over a greater space than it does on the Cordillieras of India. As the snows harden in the temperate zones, while they remain soft in the Andes of Quito, it will be possible, in all probability, to traverse the snows of the Himalaya without being obliged, as was the case with Humboldt and Bonpland to follow the narrow summits of the rocks which appear at a distance like black lines in the midst of these eternal snows. But these fatiguing excursions, the recital of which excites the interest of the public, present but few facts which are useful to the progress of the sciences. The traveller finds himself on a soil covered with snow, and surrounded by an atmosphere the chemical composition of which is the same as that of the plains, and in a situation in which delicate experiments cannot be made with the requisite precision. (See the *Ann. de Chim. et Phys.* November, 1816.)

The same number contains the memoir on the velocity of sound by M. Laplace, of which we could only give the title. It contains the following theorem:—

“The real velocity of sound is equal to the velocity given by the Newtonian formula multiplied by the square root of the specific heat of the air subjected to the constant pressure of the atmosphere, and at different temperatures to its specific heat when its volume remains constant.”

According to this rule, M. Laplace finds 345.35 metres for the velocity of sound in a second when the temperature is 48° . The

French Academicians found 337·18 metres. By the experiments of Lacaille, given in the third volume of the *Base de Systeme Metrique Decimal*, p. 342, the velocity is 344·42 metres. We do not know what was the temperature when these observations were made. They were performed in October, and in the neighbourhood of Marseilles.

Setting out from the experiments of Canton, M. Laplace found the velocity of sound in rain-water and in sea-water equal to 1525·8 and 1620·9 metres; so that the velocity of sound in fresh-water is about $4\frac{1}{2}$ times greater than in air.

Traité de Physique Experimentale et Mathématique. Par M. Biot. Four octavo volumes of more than 2450 pages. Paris, Deterville, 1816.

In his dedication to Berthollet, the author draws a picture of the present state of physics. "Every one who has had occasion to make extensive researches has seen with regret the scattered state of the materials of this fine science, and the uncertainty under which it still labours. One result is admitted in one country, and another in another. Here one numerical value is constantly employed, while in another place it is regarded as doubtful or inaccurate. Even the general principles are far from being universally adopted." The author gives as an example the three different systems of electricity, the different opinions respecting the Newtonian theory of the fits of easy transmission of light. "Hence it comes that, not being agreed about the principles of the science, we are in the situation of persons who speak in different languages which are not mutually understood. Good methods are not extended; the most fertile considerations remain long unknown, and of course barren; some parts of the science advance rapidly in one country, and remain stationary, or even retrograde, in another; not certainly that well qualified men are wanting to cultivate physics—for in the short interval of 40 years how many important results have been ascertained, how many new facts discovered!" In this place occurs a concise enumeration of the labours of Coulomb, Galvani, Volta, Malus, and several other modern philosophers. "This rapid glance over science shows us the vastness of its riches. What it wants is union. It is the junction of the parts that makes a single body of it; it is a fixing of the data and the principles which gives the same direction to all efforts. This is what I have attempted to do. The task was difficult: the public will judge of the success."

The author then enters into a detail of the valuable assistance which he obtained; and he explains the plan which he thought it requisite to follow. "Some are of opinion that physics should be presented under a purely experimental form, without any algebraic formulas. It has been said, that the precision which we conceive that we attain by its assistance is purely imaginary, because it far surpasses the limits of the errors to which the experiments are unavoidably subject. But when we have observed with precision the

different modes of the same phenomenon, and have obtained the numerical measures, what inconvenience is there in summing them by a formula which embraces them all? If they are reducible to some simple law, though not perceptible at first sight, whether the only way to discover it? To perceive the certainty of the method, and how productive it may be, we have only to observe the use that Newton made of it in his examination of the most subtle properties of light. If the book of the Optics in which these results are found has been but little understood and is now so ill appreciated, the fault is not to be ascribed to the use of algebraic formulas, but to Newton's employing, instead of formulae, a synthesis but little adapted to so many details. We shall do the work that, by means of the present mode of analytical calculation I have been able to express all the principles of that theory by means of a small number of formulas, so simple that we can deduce from them with the utmost facility all the cases resolved on pointed out by Newton, and even extend them to many others. It will be seen how much neatness the theory of fits acquires under this new view, how certain its foundation is, and with what fidelity it reproduces in their minutest details a great number of phenomena which Newton did not suspect when he established it. This manner of proceeding, which I have always endeavoured to follow, is the one which Newton has taught us in his works, and which, since the time of this great man, has been perhaps but too little followed. It is the only one that can lead us to solve this general question, comprehending under it all physics: *The circumstances which determine a phenomenon being defined to assign exactly in numbers all the particularities which will result from them.*"

Such, likewise, was the question which the ancient astronomers proposed, and which has been since so completely resolved by modern astronomers. After so clear and precise an exposition, it only remains to point out as briefly as possible the objects of which the author treats in the different parts of his work.

He first describes the instruments which are employed in all experiments; he ascertains the laws of the condensation of air and of gases, those of their dilatation by heat, and at all temperatures, those of the dilatation of solids and liquids; he treats of the forces which determine the different states of bodies, of vapours, of their mixture with gases, of evaporation, of hygrometry; of the specific gravity of gases, of liquids, and solid bodies; finally, of elasticity.

In the second book, which is consecrated to acoustics, will be found the new experiments of the author and M. Hamel.

The third book on electricity gives the analysis of the principal theories, that of Volta's pile, the discoveries of Coulomb, and the skillful calculations of M. Poisson.

The fourth book exhibits the magnetical experiments of Coulomb, Gay-Lussac, and Humboldt; and the observations of travellers on the laws of magnetism in different parts of the world.

The fifth book, on light, is one of the most considerable of the

treatise. It contains a description and calculation of the heliostat of S'Gravesend, very much improved by M. Charles: the methods and formulæ necessary to determine the laws of refraction for solids, liquids, and aeriform bodies: finally, a very detailed theory of refraction, both ordinary and extraordinary; and on the construction of micrometers with double images, which had never been explained in so luminous and complete a manner.

In his analysis of light he states, comments on, and explains, the researches of Newton; he gives the exact formulas of achromatism, and describes the apparatus which he employed in the experiments that he made in company with M. Cauchoix. We invite philosophers to consider the developments which he has given of the theory of fits of transmission and easy reflection, "all the phenomena of which may be represented with the greatest fidelity by ascribing to the molecules of light two poles, the one attractive, the other repulsive, which they present alternately to the surface of bodies by turning with a uniform motion round their centre of gravity. The particles of light would then be in the same situation as two magnets approaching each other by their two poles, either similar or dissimilar. On this view of the matter the time of the fit would be the period elapsing during the revolution of a luminous particle, and the length of the fit would be the space described by the particle during that revolution. Newton appears to have had that idea; but not to have explained it, no doubt to avoid mixing an uncertain, though probable notion, with the certainty which he had ascertained of the existence of the fit. Being at present possessed of more facts than Newton had been, we thought it right to develop it farther, stating it always as what it is."

The polarization of light is the subject of the sixth book. It is needless to say that the author has collected and classified the discoveries of Malus, his own discoveries, and those of the philosophers, both foreign and French, who have most successfully cultivated this new branch of physics.

The seventh book treats of caloric, both radiant and latent. We find in it the experiments of Herschel, Wollaston, Ritter, Boeckman, Berard, Leslie, Rumford, and De la Roche; the experiments which the author made along with M. de Candolle, the analytical inquiries of MM. Fourier and Poisson, and the labours of MM. Lavoisier and Laplace.

The last chapter treats of steam-engines. The work terminates with the memoir of MM. Pouillet and Biot on the diffraction of light.

Note respecting several Memoirs of M. Poisson.

The author has continued the researches which he presented some years ago to the Academy, the general object of which is the theory of the order and arrangement of different things without any consideration of their size—a theory still little known, which may be regarded as the foundation of algebra, and of the principal properties of numbers.

The author showed first how the system of all the possible permutations of several things may be divided into different groups of permutations, associated so that in spite of all the changes that may be made, the permutations of the same group can never separate. He likewise divides each of these principal groups into secondary groups of permutations equally inseparable; and so in succession for the successive groups, which are subdivided according to the divisors of the total number of permutations. He thus forms tables, which exhibit at once several remarkable consequences.

We know, in algebra, that if we seek to determine any function of the roots of a proposed equation, the result is elevated to the degree marked by the number of all the permutations which the roots can offer under the function considered. But it results from the preceding theory that this elevated equation is not more difficult than the one proposed itself; and that it may be actually resolved by means of equations of degrees marked by the divisors of its exponent.

This first manner of connecting permutations furnishes no data for their further reduction. But the author is enabled to group permutations in another manner, by making them proceed from each other by the same law. He can assemble in the same way the different groups which result from this. In the tables thus formed we see, without any calculation, why the equations of the first four degrees can be resolved; why the reduced equation of the fifth degree, which rises to the 120th by means of fifth radicals, and of a peculiar equation of the sixth degree, may be reduced to an equation of the fourth, as Lagrange and Vandermonde observed; but we see further that this last equation will not in reality possess the difficulties of the fourth degree, but only those of the second. The four roots of this equation give occasion for 24 transmutations, which may be connected two and two. These 12 unite, likewise, two and two. The six groups resulting, likewise, unite two and two; which reduces the whole system to three principal groups. Hence it follows that the equation of the fourth may be actually resolved by equations of the second and third degree, without assuming any particular hypothesis respecting that function which reduces these 24 values to three, considering them as equal, eight and eight.

There is likewise another remarkable table of the 24 permutations of four things, in which we see the permutations united by four to be reciprocals of each other at pleasure. This singular table contains all the ways of dividing by two and two the system of 24 permutations. The essential point in speculations of this nature, being the simplicity of the representation of so many formulas, the author finds in the new polygons which he has made known a means of reducing them and expressing them with an extreme facility.

This theory conducts naturally to that kind of numbers which Euler called *primitive roots*, and the demonstration of which ap-

peared to him one of the most difficult problems of the theory of numbers. (*Opuscules Analytiques.*) The author has obtained their analytical expression, by following a singular analogy, on which the bounds of this notice prevent us from dwelling, and which led the author to conclude that the imaginary roots of the equation of the degree $p - 1$, which are not primitive roots, ought to be the analytical representation of the primitive roots of the first number treated of; that, *viewed simply as residues relative to this prime number*, they ought to be equivalent to it; and that if to the numbers under the radical sign suitable multiples of this prime number be added (which can never change the residual values), these imaginary expressions become real, rational, and entire, give exactly the primitive roots, and produce only these numbers. This is what the author has established in different ways, and confirmed by a number of curious examples. From these imaginary expressions we may, says the author, deduce a variety of theorems on whole numbers. The theorems of Fermat and Wilson are the first consequences of them. This analysis leads to the demonstration of this new theorem respecting the formula which expresses the roots of the binomial equation of any prime degree whatever p . That the number p must necessarily enter every where as a factor under the radicals of this formula. Thus in the formula of the cube roots of unity, the number 3 must of necessity occur under the square radical. In the formulas of the fifth roots the number 5 is every where a factor of the numbers which are under the different radicals. The same holds with the 7th, 11th, 13th, 17th, &c. roots, as may be verified in the general expressions of these roots.

Euler first studied and discovered the principal properties of residues. M. Legendre simplified this theory by the consideration of indeterminate equations, and by the omission of the multiples of the prime number in the successive operations. M. Gauss simplified it still further by the new signs of these equations, which he names *congruent*. Finally, the author, occupying himself less with numbers themselves than their forms, changes these equations, or *congruents*, into true equations, and thus reduces the whole of this analysis under common algebra. This idea may lay open new routes. It is the first example of the application of algebra to the theory of numbers.

The primitive roots being very useful in analysis and in geometry, the author has endeavoured to find in arithmetic an easy method of finding them all at once for any given prime number. Suppose the prime number to be 31, as the next lowest number 30 is decomposed into the three simple factors 2, 3, 5, it is clear that the primitive roots of 31 can neither be squares, cubes, nor fifth powers; for on account of the factors 2, 3, 5, the squares would bring unity at least to the fifth power, the cubes to the tenth, and the others to the sixth. It is sufficient, then, to exclude from the 30 numbers that precede 31 those that are squares, cubes, or fifth-power rather the products of those powers. By the squares we exclude

first one-half of the numbers; by the cubes, the third of those that remain: and by the fifth powers, a fifth of the numbers still remaining. There now remain only the eight primitive roots of 31. The same thing holds for all the prime numbers p , excluding the powers marked by the simple factors of $p - 1$.

In the *Nova Commentaria* of Petersburg, Euler says that we are not in possession of any method of discovering these roots.

We cannot seek for any of these roots separately, because they are united, as we have seen, in an inseparable manner. But we find them all at once, either by the resolution of the equation which contains them, or by the arithmetical method of which we have just spoken.

We shall terminate this imperfect notice of the labours of the Royal Academy of Science by the statement by M. Bouvard of a very faint comet, and very near the pole, discovered at Marseilles by M. Pons about the end of January, 1716; and by the simple mention of two notes in which M. Rochon has described the method that he followed in repairing two broken objectives, the one by Dolland, the other by Campani. To unite the fragments, M. Rochon employed turpentine. These first attempts were crowned with the fullest success.

On Aug. 12, 1816, M. Gay-Lussac exhibited a new barometer, the construction and advantages of which he explained verbally.

ARTICLE XII.

SCIENTIFIC INTELLIGENCE; AND NOTICES OF SUBJECTS
CONNECTED WITH SCIENCE.

I. *Titanium and Tellurium in Sulphuric Acid.*

WE are informed, on the authority of Professor Berzelius, that small quantities of titanium are occasionally found in sulphuric acid of English manufacture; and that in sulphuric acid from a manufactory at Stockholm, minute portions of tellurium, in the state of sulphuret, have been found mixed with unburned sulphur. The sulphur employed in this latter manufactory is obtained from pyrites found in the mine of Fahlun, in which no traces of tellurium have yet been discovered.

II. *Service of Plate presented to Sir H. Davy.*

The proprietors of the collieries in the counties of Northumberland and Durham have presented to Sir H. Davy a service of plate, valued, as it is said, at nearly 2,000*l.* It is a tribute of respect to which he is justly entitled, from the rare union of profound scientific research with the direct application of it to purposes of practical utility, which characterize his inquiries into the properties of the

fire-damp, and the methods by which the fatal accidents may be prevented which have so frequently occurred from its explosion.

III. Case of Miss M'Avoy.

On the subject of this singular case, of which an account was given in the number of the *Annals* for October, a correspondent from Liverpool makes the following observation:—"Miss M'Avoy is still the great subject of discussion at all the parties in Liverpool: the chief difficulty seems to be to *blind* her completely; the goggles (goldbeaters' skin with a black patch over it) not being satisfactory. _____ tried them on, and found that, from their not fitting quite tight to the eye, she could see, and did tell colours, and read, as Miss M'Avoy does."

IV. Mineral Water of Schooley's Mountain.

The mineral water of Schooley's Mountain, in New Jersey, U.S. has acquired some considerable local celebrity, and has been the subject of a paper by W. J. M'Niven, M.D. read before the Literary and Philosophical Society of New York. From this paper the following particulars are extracted:—

The spring is situated in a defile between two wooded hills, and issues from the side of a steep rock about 40 or 50 feet above the level of the brook that runs through the valley.

The quantity of water discharged by this spring is but small, not exceeding 580 gallons in 24 hours. Its most active ingredient appears to be carbonate of iron, held in solution by so small a proportion of carbonic acid (about one-third of its bulk) that it neither sparkles when poured from one vessel into another, nor produces any change of colour in an infusion of litmus.

One gallon affords by evaporation 7.09 grains of solid matter, of which are—

Carbonate of lime	3.4 gr.
Muriate of lime	1.18
Carbonate of iron	1.0
Vegetable extractive matter	0.5

together with very minute proportions of the muriates of soda and of magnesia, sulphate of lime, carbonate of magnesia, and silex.

The temperature of the water as it issues from the spring is = 52 Fahr.

It is used externally and internally, and appears to have been exhibited with good effects in nephritic complaints.

V. Patent Malt.

There are few patents that promise to be of such great importance as one lately obtained by D. Wheeler, of a new and improved method of preparing brown malt.

The essential difference between ale and porter is,

liquor is of a much deeper colour than the former, and has besides a peculiar empyreumatic flavour, not easily defined, though universally known. This colour and this flavour were originally obtained by mixing with the pale malt commonly used for brewing a certain proportion of malt dried at a somewhat higher temperature, and in consequence of being thus slightly scorched, capable of communicating to the water in which it is infused a deep tan-brown colour and a peculiar flavour.

In the composition of the best genuine porter two parts of brown malt are required to three parts of pale malt. The price of the former is generally about $\frac{1}{3}$ of the latter; but the proportion of starchy matter which it contains does not, according to the highest estimate, exceed one-half of that afforded by the pale malt, and probably on an average scarcely amounts to $\frac{1}{3}$. Taking, however, the proportion of sugar in brown malt even at about one-half, it follows that the porter brewers are paying for the colour and flavour of their liquor $\frac{1}{3}$ of the entire cost of their malt. The price of this latter article has of late years increased so enormously, and the mutual competition of the manufacturers has become so active, as to offer temptations, not easily resisted, either of supplying the flavour and colour of porter by the use of Spanish liquorice, burnt sugar, and other similar ingredients, which, however innocent in themselves, are prohibited by the Legislature, or of diminishing the strength of the liquor: thus rendering it more liable to become sour or vapid by keeping, and hence bringing on the necessity of using alkaline substances to correct the first, and deleterious narcotics, such as cocculus indicus, to supply the deficiency of alcohol. The result of all this is, that a large quantity of ill-made noxious liquor is forced upon the public, that the diminished strength of such as is made of allowed ingredients drives multitudes of the lower classes to the use of gin and opium, and that the scandalous frequency of frauds on this branch of the revenue has entirely abolished all moral feeling on the subject, and reduced it to a mere calculation of expediency.

It appears that the patentees have discovered that, by exposing common malt to a temperature of about 430° Fahr. in close vessels, it acquires a dark chocolate-brown colour, and is rendered so soluble in water, either hot or cold, that, when mixed with pale malt in the proportion of $\frac{1}{10}$, it communicates to the liquor the perfect colour and flavour of porter.

From this it follows that the brewer, by employing four parts of pale malt and $\frac{1}{10}$ of a part of patent malt may obtain a stronger liquor than from his usual proportions of three parts of pale and two parts of brown malt. The saving thus occasioned ought in equity to be divided between the patentees, the brewer, and the public. The revenue will be benefited by the increased consumption which will necessarily result from an improvement in the quality of the porter: and both the revenue and public morals will derive advantage from the greatly diminished temptation to fraudulent practices.

VI. *Atmospherical Phenomenon.*

(To Dr. Thomson.)

SIR,

Not being an habitual observer of atmospherical phenomena, I beg to trouble you, and your correspondents on those interesting subjects, with a description of one I lately saw, in the hope, if not of a solution, at least of some probable explanation of so curious a circumstance.

While standing one warm evening, after a warmer day, during the past summer, just below the turnpike on the castle hill above Dover, I observed a column of black clouds coming with rapidity from the north, and another column of less density from the south. I determined to observe the consequences of their meeting together, which I took for granted would happen not far above the hill between which and the sea Dover stands, and which, having been strongly fortified during the late war, is now termed the citadel. On ascending to the most elevated part of the castle hill, I found, to my surprise, that still another wind was blowing from the east, from which I was before protected. This added to the interest already felt, and I expected with some impatience the consequences of this third wind upon the two columns of clouds marching with nearly equal rapidity towards each other, for their direction could only result, as I conceive, from the operation of two winds, one blowing from the north, the other from the south. As, when these columns appeared to be less than a mile apart, they were not affected by the current from the east, I began to suspect that it must be very narrow. When, however, the extremities of the two columns were nearly in contact, each received a sort of check to its progress for a short time, but soon afterwards both tumbled round, if I may so express myself, into the current from the east, and continued so to do, as they came up to it, proceeding together, nearly in a westerly direction, along the line of the coast towards Folkstone.

SILLCRETE.

VII. *Aerolite at Paris.*

We are informed from the French papers that an aerolite of considerable size fell in Paris, in the Rue de Richelieu, on the morning of Nov. 8. It descended with so much force as to displace a part of the pavement, and to sink to some depth into the earth. It was attended by a sulphureous smell, and seemed to have been recently in a state of ignition or combustion.

ARTICLE XIII.

New Patents.

ROBERT HARDY, of Worcester, iron-founder; for improvements in the manufacturing of cast-iron bushes, or pipe boxes, for chaise, coach, waggon, and all other sorts of carriage wheels. Feb. 20, 1817.

RICHARD LITHERLAND, of Liverpool, watch-maker; for improvements in or on the escapement of watches. Feb. 20, 1817.

RICHARD HOLDEN, Stafford-street, parish of St. Mary-le-bone, Gentleman; for machines for producing rotatory and pendulous motions in a new manner. Feb. 20, 1817.

DANIEL WILSON, of Dublin, Gentleman; for gas light apparatuses, processes, and philosophical instruments. March 1, 1817.

WILLIAM HENRY OSBORN, of Bordesley, near Birmingham; for a method or principle of producing cylinders of various descriptions. March 1, 1817.

URBANUS SARTORIS, of Winchester-street, merchant; for improvements in the construction and use of fire-arms. March 11, 1817.

LUDVIG GRANHOLM, Captain of the Royal Navy of Sweden, living in Foster-lane, London; for a process, mean, or means, for pressing vegetable and animal products. March 11, 1817.

WILLIAM RAYBOULD, of Goswell-street, brass-founder; for an improvement applicable to fire-stoves, grates, and ranges, of various descriptions. March 11, 1817.

WILLIAM PANTER, of Hampton Hill, Bath, Gentleman; for an improvement to facilitate rotatory motion, and lessen or improve friction in wheel carriages, and machinery of various descriptions. March 16, 1817.

JOHN WINTER, jun. Bristol, comb-maker; for a method of joining and combining horn and tortoise-shell together, by heat and pressure, causing the same to adhere to one another, in such a way as to have the appearance of solid tortoise-shell, and possessing the strength and elasticity of horn, by which he will be enabled to manufacture and vend the various articles of hair combs, ornamental and other combs, also snuff-boxes made of those materials, at a reasonable rate, and resembling and having the appearance and beauty of real tortoise-shell. March 18, 1817.

DANIEL WHEELER, of Hyde-street, Bloomsbury, colour-maker; for a method of drying and preparing malt. March 28, 1817.

EDWARD NICHOLAS, of Llangattock bibon Avell, farmer; for a plough to cover wheat and other grain with mould when sown. April 19, 1817.

ANTONIO JOAQUIN FRIERE MARROCE, of Broad-street-buildings, merchant; for a method of making or manufacturing an im-

proved machine or instrument for calculating and ascertaining the longitude at sea. Communicated to him by Luis Coctane Altina de Campos, residing abroad. April 29, 1817.

WILLIAM COLLINS, of Maize Hill, Greenwich, Esq.; for an improvement or improvements in the composition and preparation of a metal for manufacturing it into sheets or plates, and the application of it to the preservation of ships, by sheeting or covering the bottoms of them with it; and for an improvement or improvements of the chain-pumps used on board of ships. May 6, 1817.

HENRY WILMS, of Union-street, Lambeth, cabinet-maker; for an artificial leg, arm, and hand, on an improved construction. May 8, 1817.

JAMES GERARD COLBERT, of Winsley-street, Mary-le-bone, mechanical watch-maker; for improvements in the method or methods of making screws of iron, brass, steel, or other metals, for the use of all kinds of wood-work. Communicated to him by a foreigner residing abroad. May 13, 1817.

JOHN WALKER, of Great Charles-street, Blackfriars-road, millwright; for an improved method of separating or extracting the molasses or treacle out of muscovado, brown, or new sugar. May 13, 1817.

RICHARD WILLIAMS, the elder, of Fursley, card-maker; for improvements in the manufacturing of cards for dressing woollen cloths. May 13, 1817.

ARCHIBALD THOMSON, of Church-street, Blackfriars-road, machinist and engineer; for a machine for cutting corks. May 17, 1817.

WILLIAM OWEN, of Wrexham, cabinet-maker; for a portable table or box mangle, upon a new principle, for getting up and smoothing linen, cotton, and other articles. May 17, 1817.

WILLIAM BOUND, of Ray-street, Clerkenwell, ironfounder; and **WILLIAM STONE**, of Berkley-street, in Clerkenwell also, brassfounder; for a method of applying certain apparatus for converting the fuel for heating retorts of gas-lights apparatus into coke or charcoal. May 17, 1817.

ROBERT SALMON, of Woburn, Bedfordshire, Gentleman; for an apparatus for the more useful, safe, pleasant, and economic, use of candles; and also improvements in the apparatus now in use for part of the same ends. May 17, 1817.

BENJAMIN COOK, of Birmingham, gilt toy-maker; for an improved method of making and constructing rollers and cylinders, both solid and hollow, which will be found useful in various manufactories in this kingdom. May 17, 1817.

ROGER DIDOT, formerly a paper manufacturer in France, now living at Paddington, near London; for certain improvements upon the machines already in use for making wove and laid paper in continued lengths or separate sheets. May 22, 1817.

ARTICLE XIV.

Magnetical and Meteorological Observations.

By Col. Beaufoy, F.R.S.

*Bushey Heath, near Stanmore.*Latitude $51^{\circ} 37' 43''$ North. Longitude west in time $1^{\circ} 20' 4''$.*Magnetical Observations, 1817. — Variation West.*

Month.	Morning Observ.			Noon Observ.			Evening Observ.	
	Hour.	Variation.		Hour.	Variation.		Hour.	Variation.
Oct. 1	8h 40'	24° 33'	33"	1h 35'	24° 39'	43"		
2	8 40	24 36	08	—	—	—		
3	8 40	24 39	57	1 40	24 41	25		
4	8 35	24 28	48	1 35	24 39	55		
5	8 35	24 30	08	1 35	24 40	31		
6	8 35	24 30	06	1 25	24 40	51		
7	8 40	24 31	31	1 36	24 42	05		
8	8 30	24 30	41	1 35	24 43	20		
9	8 25	24 31	08	1 30	24 42	55		
10	8 40	24 31	05	1 30	24 42	17		
11	8 30	24 30	31	1 30	24 40	08		
12	8 30	24 34	36	1 35	24 41	54		
13	8 25	24 33	24	1 35	24 42	05		
14	8 30	24 31	59	1 20	24 42	56		
15	8 35	24 28	04	1 30	24 39	03		
16	8 25	24 30	10	1 35	24 40	03		
17	8 25	24 29	38	1 20	24 41	11		
18	8 20	24 30	00	—	—	—		
19	8 25	24 29	58	1 25	24 40	08		
20	8 25	24 30	58	1 25	24 42	08		
21	8 20	24 32	50	1 50	24 43	53		
22	8 30	24 34	47	1 25	24 40	12		
23	8 25	24 31	52	1 30	24 38	21		
24	8 25	24 32	08	1 45	24 37	53		
25	8 30	24 31	25	1 30	24 39	45		
26	8 35	24 29	44	1 35	24 41	16		
27	—	—	—	1 25	24 43	33		
28	8 40	24 31	46	1 15	24 38	28		
29	8 30	24 30	16	1 25	24 39	07		
30	—	—	—	1 20	24 38	46		
31	—	—	—	1 30	24 37	13		
Mean for Month.	8 31	24 31	06	1 31	24 40	46		

Owing to the shortness of the days, evening observation discontinued.

Oct. 31.—At the commencement of the noon observations the variation was $24^{\circ} 37' 23''$ W., the wind being to the south of the west. As the wind became more westerly, in a few minutes the variation decreased to $24^{\circ} 27' 45''$, and then increased to $24^{\circ} 37' 13''$. This was followed by a hard squall, with rain, from west by north.

Meteorological Table.

Month.	Time.	Barom.	Ther.	Hyg.	Wind.	Velocity.	Weather.	Six's.
Oct.		Inches.				Fcet.		
	1	Morn....	29.376	45°	65°	NNE	Cloudy	41
		Noon....	29.345	54	54	N	Fine	55
		Even....	—	—	—	—	—	35
	2	Morn....	29.630	39	53	N	Very fine	48
		Noon....	—	—	—	—	—	35
		Even....	—	—	—	—	—	52
	3	Morn....	29.650	40	60	NNW	Clear	38
		Noon....	29.645	50	45	NE	Very fine	57
		Even....	—	—	—	—	—	37
	4	Morn....	29.758	45	56	E by N	Clear	55
		Noon....	29.758	54	44	E by N	Cloudy	35
		Even....	—	—	—	—	—	54
	5	Morn....	29.844	44	55	ENE	Fine	40
		Noon....	29.840	52	48	ENE	Clear	56
		Even....	—	—	—	—	—	44
	6	Morn....	29.853	42	57	ENE	Cloudy	55
		Noon....	29.818	53	44	E	Fine	39
		Even....	—	—	—	—	—	54
	7	Morn....	29.784	48	58	ENE	Fine	41
		Noon....	29.781	56	44	ENE	Clear	55
		Even....	—	—	—	—	—	41
	8	Morn....	29.700	48	53	E by N	Very fine	49
		Noon....	29.658	54	46	E	Cloudy	50
		Even....	—	—	—	—	—	37
	9	Morn....	29.585	46	64	E	Very fine	52
		Noon....	29.585	53	48	E	Showery	36
		Even....	—	—	—	—	—	51
	10	Morn....	29.485	46	60	NNE	Cloudy	42
		Noon....	29.485	54	46	NNR	Mizzle	49
		Even....	—	—	—	—	—	38
	11	Morn....	29.580	49	59	N by E	Showery	50
		Noon....	29.550	47	53	N	Cloudy	37
		Even....	—	—	—	—	—	52
	12	Morn....	29.610	43	62	N	Very fine	36
		Noon....	29.600	51	60	N	Showery	51
		Even....	—	—	—	—	—	42
	13	Morn....	29.778	44	64	NE by N	Showery	49
		Noon....	29.808	51	54	NR	Cloudy	38
		Even....	—	—	—	—	—	45
	14	Morn....	29.817	42	65	NNW	Very fine	37
		Noon....	29.783	49	50	NNW	Showery	51
		Even....	—	—	—	—	—	42
	15	Morn....	29.625	44	74	NNW	Mizzle	49
		Noon....	29.558	48	72	NW by N	Showery	38
		Even....	—	—	—	—	—	45
	16	Morn....	29.423	44	84	NE	Showery	37
		Noon....	29.472	44½	75	E	Showery	49
	Even....	—	—	—	—	—	38	
17	Morn....	29.658	42	63	ENE	Showery	49	
	Noon....	29.648	48	58	E by N	Showery	38	
	Even....	—	—	—	—	—	44	
18	Morn....	29.800	40	63	NE by N	Cloudy	44	
	Noon....	—	—	—	—	—	—	
	Even....	—	—	—	—	—	—	

Meteorological Table continued.

Month.	Time.	Barom.	Ther.	Hyg.	Wind.	Velocity.	Weather.	Six's.
Oct.		Inchs.				Feet		
	Morn....	29.483	43°	75°	NNE		Cloudy	39°
19	Noon....	29.465	45	59	NNE		Cloudy	45½
	Even....	—	—	—	—		—	—
	Morn....	29.510	43	68	NNE		Mizzle	43
20	Noon....	29.510	47	56	NNE		Cloudy	47
	Even....	—	—	—	—		—	—
	Morn....	29.467	43	75	NE		Cloudy	42
21	Noon....	29.432	48	60	E by S		Cloudy	49
	Even....	—	—	—	—		—	—
	Morn....	29.385	43	72	N by W		Foggy	42
22	Noon....	29.400	48	69	N		Cloudy	48
	Even....	—	—	—	—		—	—
	Morn....	29.510	44	79	N by E		Cloudy	40
23	Noon....	29.512	49	55	NR		Showery	50
	Even....	—	—	—	—		—	—
	Morn....	29.485	42	72	NE by E		Mizzle	41
24	Noon....	29.467	45	67	E		Showery	45
	Even....	—	—	—	—		—	—
	Morn....	29.403	42	75	E by S		Cloudy	40
25	Noon....	29.392	46	64	S by W		Foggy	46
	Even....	—	—	—	—		—	—
	Morn....	29.300	42	64	SE		Cloudy	40
26	Noon....	29.300	49	55	S		Cloudy	49½
	Even....	—	—	—	—		—	—
	Morn....	—	—	—	—		—	38
27	Noon....	29.125	47	60	SW		Cloudy	49
	Even....	—	—	—	—		—	—
	Morn....	29.025	38	74	S		Very fine	36
28	Noon....	28.985	47	56	SSE		Showery	49
	Even....	—	—	—	—		—	—
	Morn....	29.043	39	72	SW		Cloudy	35
29	Noon....	29.065	44	63	SW by S		Hail	45
	Even....	—	—	—	—		—	—
	Morn....	—	—	—	—		—	35
30	Noon....	28.800	55	70	W by S		Showery	56
	Even....	—	—	—	—		—	—
	Morn....	—	—	—	—		—	43
31	Noon....	29.065	50	68	W by N		Showery	52
	Even....	—	—	—	—		—	—

ARTICLE XV.

METEOROLOGICAL TABLE.

1817.	Wind.	BAROMETER.			THERMOMETER.			Hygr. at 9 a. m.	Rain.
		Max.	Min.	Med.	Max.	Min.	Med.		
10th Mo.									
Oct. 3	N E	30·14	30·05	30·095	50	32	41·0	65	
4	N E	30·22	30·14	30·180	57	32	44·5	55	
5	N E	30·25	30·22	30·235	56	53	44·5	56	
6	N E	30·25	30·10	30·175	54	39	46·5	55	
7	E	30·10	30·06	30·080	54	43	48·5	51	
8	N E	30·06	29·95	30·005	54	35	44·5	46	
9	N E	29·95	29·87	29·910	53	39	46·0	59	
10	N	29·92	29·86	29·890	56	41	48·5	56	
11	N E	29·99	29·92	29·955	50	36	43·0	54	—
12	N	30·15	29·99	30·070	52	35	43·5	55	5
13	N E	30·22	30·17	30·195	52	32	42·0	59	—
14	N	30·22	30·02	30·120	50	42	46·0	64	—
15	N W	30·02	29·80	29·910	48	37	42·5	64	6
16	N E	30·05	29·80	29·925	48	36	42·0	60	·30
17	N E	30·05	29·86	29·955	48	37	42·5	59	·5
18	E	29·87	29·77	29·820	45	37	41·0	54	·17
19	N	29·91	29·87	29·890	45	42	43·5	62	
20	N	29·89	29·85	29·870	48	40	44·0	64	3
21	E	29·79	29·77	29·780	52	39	45·5	65	
22	N	29·90	29·79	29·845	48	36	42·0	65	
23	N E	29·90	29·88	29·890	50	40	45·0	63	—
24	N E	29·88	29·81	29·845	46	38	42·0	65	4
25	S E	29·81	29·71	29·760	50	37	43·5	65	
26	S	29·69	29·65	29·670	52	28	40·0		
27	S W	29·43	29·32	29·375	49	32	40·5		·12
28	S W	29·41	29·39	29·400	48	32	40·0		·16
29	S W	29·55	29·21	29·380	49	27	38·0		8
30	S	29·49	29·14	29·315	57	42	49·5		·21
31	S	30·25	29·46	29·855	52	28	40·0		7
11th Mo.									
Nov. 1	Var.	30·34	30·16	30·250	49	27	38·0		
		30·34	29·14	29·881	57	27	43·27		1·34

The observations in each line of the table apply to a period of hours, beginning at 9 A. M. on the day indicated in the first column; and the result is included in the next following observation.

REMARKS.

Tenth Month.—3. Hoar frost, with ice. 4. A strong breeze: clear morning: the wind, p. m. tending to SE, with *Cumuli*. 5. The same breeze still: *Cumulus*, succeeded by *Cumulostratus*, which became heavy by noon, when the smoke of the city, being drawn up in a column in the SW, mingled with the clouds, and gave occasion (as it appeared) to a local shower: it drizzled a little with us, and there was a bank of clouds beneath dewy haze in the NE at sun-set. 6, 7. Some wind, especially by night: *Cumulostratus*. 8. *Cumulus*, &c.: windy. 9. *Cumulostratus*: windy: SE, p. m. 10. *Cumulostratus*, somewhat heavy, with an excessive rising of the dust in the evening. 11. A fresh breeze again, with *Secy Cumulus* and *Cirrostratus*: a little rain, mid-day: very fine orange twilight. 12. As yesterday: slight showers by insculation of different clouds: the product of the rain-gauge includes much dew. 13. A strong breeze, NNE, a. m.; some drizzling rain: twilight fainter orange. 14. Misty morning: a little drizzling, p. m. 15. Some rain, mid-day and evening. 16. Wind got back to NE, and fresh, a. m.: rainbow at eleven: wet, mid-day: then cloudy. 17. Showers, with hail, about noon. 18. Cloudy: wind fresh, going first to NW, then back to E: showers. 19. Temp. 45° at nine, a. m.: dark and cloudy through the day. 20. Gloomy: misty: but little wind. 21. The same. 22. Lighter sky: wind to SE, and at night back to N. 23. Wind brisk at NNE, with a lofty sky: a shower, p. m. 24. Drizzling: dark, a. m. 25. Fair: *Cumulus*, with *Cirrocumulus* and *Cirrostratus*: the moon rose gold-coloured: a clear night ensued. 27. Misty morning: rain, with wind, at night. 28. Misty: the trees dripping: the wind to S, then back to SW, with pretty heavy rain. 29—31. After a moderate gale from the southward, the barometer rose rapidly, with squalls of wind, showers, and hoar frost.

Eleventh Month.—1. Very fine day: misty at night, probably from a *Stratus*.

RESULTS.

The wind, which was chiefly from the NE to the time of the full moon, came round afterwards (as in the last period) to the SW for a few days only.

Barometer: Greatest height.....	30.34 inches.
Least	29.14
Mean of the period	29.881
Thermometer: Greatest height.....	57°
Least	27
Mean of the period.....	43.27
Rain.....	1.34 inches.

The hygrometer having been out of order, the latter week's observations on it are uncertain. I found the *evaporation* to proceed of late in the following ratio, viz. :—

In eight days preceding the 3d of 10th month	0.42 inch
In seven days preceding the 10th	0.37
In seven days preceding the 17th	0.22
In eight days preceding the 25th.....	0.10
In eight days to the close of the period (with considerably more wind stirring)	0.12

The capacity of the air for water has, therefore, decreased more rapidly than the daily mean temperature, the change of the atmospheric current being the probable cause.

INDEX.

A DAMS, Mr. James, table of differential equations, by, 116—
 explanation of the characteristics d
 and t , by, 338—mathematical prob-
 lem, by, 430.
Aerolite at Paris, 407.
Africa, on the mode of exploring the
interior of, 103.
Agrarian measures of the ancient
Egyptians, 382.
Ammoniacal salts, experiments on, 203.
Animals, distribution of, 224.
Arragonite, experiments on, 151—
crystalline figure of, 378.
Arsenic, tests for, 60.
Arsenious acid, method of detecting,
151.
Asia; on the ancient geography of cen-
tral, 51.
Azote, on the compounds of, with oxy-
gen, 38.

B.

Baffin's Bay, remarks on, 427.
Ballston water, analysis of, 442.
Barbançois, M. on the arrangement of
airtials, 292.
Barchard, Mr. improvement in
Brooke's blow-pipe, by, 66—on the
cells of bees, 428.
Barclay, Dr. on the combs and cells of
bees, 14.
Barkouski, Count, on the sodalite of
Vesuvius, 141, 192.
Barley meal, constituents of, 368.
Barlow, Mr. on the heat given out
when iron is drawn asunder, 311.
Barometer, on its absence, 47.
Barton, Dr. W. on a new species of
malaxis, 56.
Béan, a perennial, 391.
Beaufoy, Col. remarks on naval sub-
jects, by, 6—Magnetical and meteoro-
logical tables, by, 76, 156, 236,
316, 396, 470—suggestions by, for
building experimental vessels, &c.
256—on the north-west passage, 424.
Beauvois, M. Flora of Owara and Be-
nja, by, 222.
Bees, on the combs and cells of, 14,
428.
Berger, Dr. on the specific gravity and
temperature of sea water, 139.
Berzelius, Professor, on tellurium in
sulphuric acid, 464.

Belladonna, effects on vision, 432.
Béland, M. on salt and fresh water
shell-fish, 144.
Bigge, Mr. on the mineralogy of the
Cheviots, 140.
Biot, M. *Traité de Physique*, par, 450.
Bitartrate of potash, primary form of,
37.
Blainville, Dr. on the spur of the ornitho-
rhinchus paradoxus, 119.
Blind woman who can read by the
points of her fingers, account of, 386.
Blow-pipe, Brooke's, improvement in,
66.
Bonnard, M. observations by, on the
position of granite, 148.
Booth, Mr. improvement in Brooke's
blow-pipe, by, 67.
Boy, blind and deaf, observations on,
50.
Braconnot, M. analysis of rice by, 166.
Brewing, 388.
Brewster, Dr. on the action of transpar-
ent bodies on the differently coloured
rays, 49—description by, of a dark-
ening glass for solar observations, 50
—on the optical properties of calca-
reous spar, 54—of common salt,
fluor spar, diamond, 52.
Brewster, Rev. James, on the remark-
able case of Margaret Lysell, 53.
Brochant, M. on transition rocks, 142.
Brownrigg, Dr. biographical account
of, 321, 401.
Brunatelli, M. method of detecting
arsenious acid or corrosive sublimate,
by, 151.
Buckland, Rev. W. on the plastic clay
formation, 56.
Butter of antimony, 149.

C.

Cadell, W. A. Esq. on the sugar yielded
by the acer pseudoplatanus, 231.
Calculus disorders, Marscat's account
of, 443.
Campbell, John, Esq. on vision, 17.
Carro, Jean de, M. D. account of, 1.
Cassini, M., on certain compound
flowers, 223.
Cerasin, 147.
Chaussier, M., on medical jurispru-
dence, 202.
Cheviots, mineralogy of, 140.

Chlorides, composition of, 275.
 Christison's application of fluxions, 417.
 Cinnamon of, as an article of commerce, 346.
 Clarke, Dr., fusion of wood-tin by, 70.
 —New experiments by, 133. Improvement in the gas blow-pipe by, 373.

Clouds, on the nomenclature of, 306.
 Coal found in Russia, 233.—New species of, 61.

Coal pit, explosion in, 231.
 Coal vessel, explosion on board a, 233.
 Cobalt, analysis of the ores of, 228.

Comets of 1783 and 1793, 390.
 Comet, new one discovered by M. Pons, 464.

Common salt, optical properties of, 52.
 Compass, variation of in the northern ocean, 427.

Corrosive sublimate, method of detecting, 151.

Cremation, on the origin of, 50.
 Cubature of wood, Pronoy's remarks on, 455.

Cuvier, M., account of his Règne Animal distribué d'après son Organisation, 127, 291. On the anatomy of the marmoset, 290.

D.

Dalton, Mr. John, on the chemical compounds of azote and oxygen, 38, 83.

Darkening glass for solar observations, 50.

Davy, Sir H., researches on flame, 447—service of plate presented to, 464.

Davy, Dr. John, on the temperature of the ocean and specific gravity of the sea in tropical climates, 54.

Deliquescent substances, on the preservation of, 29.

Deutosulphuret of copper, 148.

Dewar, Dr., on the method of preserving volatile and deliquescent substances, 29—on the blind and deaf boy, 50.

Diamond, optical properties of, 51.

Dick, Thomas Lauder, Esq., on different currents of wind at the same time, 16.

Differential equations, table of, 116.

Dixon, Dr. his biographical account of Dr. Brownrigg, 321, 401.

Donovan, Mr. essay by on galvanism, 129.

Dunglison on vision, 432.

E.

Edmonston, H. Esq., on the mode of exploring the interior of Africa, 103.

Egg singularly formed, 69.
 Emetics, 150.

Ether, silent combustion of its vapour, 451.

Euler's algebra, translator of, 152, 311.

Extracts, on preparing, 306.

Explosion in a coal-pit, 231—on board a coal vessel, 233.

F.

Fibrinous calculus, account of, 445.

Flint spar, optical properties of, 54.

Fluxions, applied to lines of the second order, 417.

Fox's account of the weather at Plymouth, 434.

Freyberg, sketch of the Mining Academy at, 61.

G.

Galvanism, essay on, 129.

Garden, Mr. account of a remarkable mineral water by, 72.

Garthshore, Dr. Maxwell, biographical account of Dr. Ingenhousz by, 161.

Gas blow-pipe, experiments with, 133—improvements in, 303, 367, 373.

Geological Society, meetings of, 58, 139.

Girard, M. on the theory of the motion of water in capillary tubes, 384.

Glover, Rev. T. account by of a blind woman, who can read by the points of her fingers, 286.

Gordon, Dr. John, on the blind and deaf boy, 50.

Gorham, Dr. examination by of sugar supposed to be poisoned, 197.

Govan, Mr. on the effect of lightning on a tree, 389.

Granite, on the positions of, 143.

Gregor, Mr. new species of coal discovered by, 61—death of, 153.

Greenland supposed to be an island, 427.

Grotthus, his experiments on flame referred to, 447, 449.

Gum from the Congo, 147.

H.

Hatchette, M. on the running of liquids through small orifices, 31, 214.

Harvey, Mr. George, elementary ideas by, on the first principles of integration, 264.

Hedge-hog, on, 307.

Herschell, Sir W. on the distribution of the stars, 55.

Himalayar mountains, observations on the height of 456.
 Holt, Mr. experiments by, to show that the bean is perennial, 391.
 Holmite, 71.
 Home, Sir Everard, on the difference between the sepia and shell vermes, 55.
 Hordein, 388, 389.
 Horner, Mr. solution of the equation, $\sqrt{x} = x$ by, 341.
 Howard, Luke, Esq., meteorological tables, by 79, 159, 239, 319, 399, 473—Description of a descending land spout by, 146.
 Humboldt, M., on the distribution of plants, 221; on the Indian mountains, 456.
 Hydrochloric acid, liquid, quantity of real acid in, 269, 369.

I.

Jackson, Dr., elementary demonstration by, of the composition of pressures, 53.
 Jamieson, Dr. John, on the origin of cremation, 50.
 Ice, formed by means of oatmeal, 61.
 Indian mountains, Humboldt's remarks on, 456.
 Ingenhousz, Dr., biographical account of, 161.
 Insects which live in a vacuum, 151.
 Integration, on the first principles of, 264.
 Jonnés, M. Moreau de, on the geology of Martinique, 145—on the yellow viper, 226.
 Johnson, Mr., on a lactometer, 304—on a rain gage, 305—on preparing extracts, 305.
 Iron, curious effect of paste on, 302.

K.

Kidney bean, a perennial, 391.

L.

Lactometer, on a, 304.
 Lamarck, M., on animals without vertebrae, 291.
 Lamouroux, M., on corals, 391.
 Laplace, M., on determining the length of the pendulum, 296—on the velocity of sound, 458.
 Latreille, M., on the distribution of insects, 224.
 Languier, M., experiments by, on arra-

gonite, 152—analysis of the meteoric iron of Siberia, by, 152.
 Laurus cinnamomum, description of, 241.
 Leach, Dr., on the genus ocythoæ, 55.
 Leet, Mr. on the action of vinegar on cast-iron, 394.
 Leslie, Professor, produces ice by means of oatmeal, 61.
 Lichnis dioica, on the red and white varieties of, 56.
 Licoperdon solidum, 56.
 Licopodium denticulatum, seeds of,
 Lightning, effect of, on a tree, 389.
 Ligurian mountains, on the mineralogy of, 59.
 Linnæan Society, meetings of, 56.—Office bearers in, 56.
 Lyall, Margaret, remarkable case of, 53.

M.

M'Avoy, Miss, an account of, 268, 465.
 M'Niven, Dr., on the water of Schooley's mountain, 465.
 Macbride, Dr., on the licoperdon solidum, 56.
 Magendie, M., on emetin, 150.—Experiments by, on feeding animals with food destitute of azote, 292.
 Magnetical observations 76, 156, 236, 316, 396, 470.
 Malaxis, new species of, 56.
 Malt, constituents of, 388.—Patent 465.
 Marcet's essay on calculous complaints, 443.
 Marshall, Henry, Esq., on the laurus cinnamomum, 241.—On cinnamon, as an article of commerce, 346.
 Massa, S. Giovanni, on the mineralogy of the Ligurian mountains, 59.
 Meteorological tables, 77, 157, 237, 317, 397, and 470.
 Mineral waters, general formula for the analysis of, 93.
 Mitchell, James, the blind and deaf boy, on, 50.
 Morphium, 153.
 Moyle, Mr., machine for raising heavy weights by, 65.
 Murray, Dr. John, on the analysis of sea water, 51.—General formula by, for the analysis of mineral waters, 93.
 Murray, Hugh, Esq. on the ancient geography of central Asia, 51.

N.

Naphtha of Amaino, properties and composition of, 118.



